



SURGICAL & MEDICAL SUPPLIES PTY LTD

Viva Medical Carts

Medical Cart Guide	2
Anaesthetic Carts	3
Emergency Carts	4
Procedure Carts	7
Isolation Carts	13
Medication Carts	14
IT Equipment Carts	17
IT Equipment Cart Options	19
Service Trolleys	20
File Carts	23
Medical Cart Accessories	25



SURGICAL AND MEDICAL SUPPLIES PTY LTD
16 Kensington Road Rose Park SA 5067
Telephone: (08) 8332 1666 Fax: (08) 8332 5132
Email: sales@surmed.com.au
Website: www.surmed.com.au

For enquiries, contact:
Chris Lee
Product Specialist
m. 0476 777 767
e. clee@surmed.com.au

February 2023

Width Options



Height Options

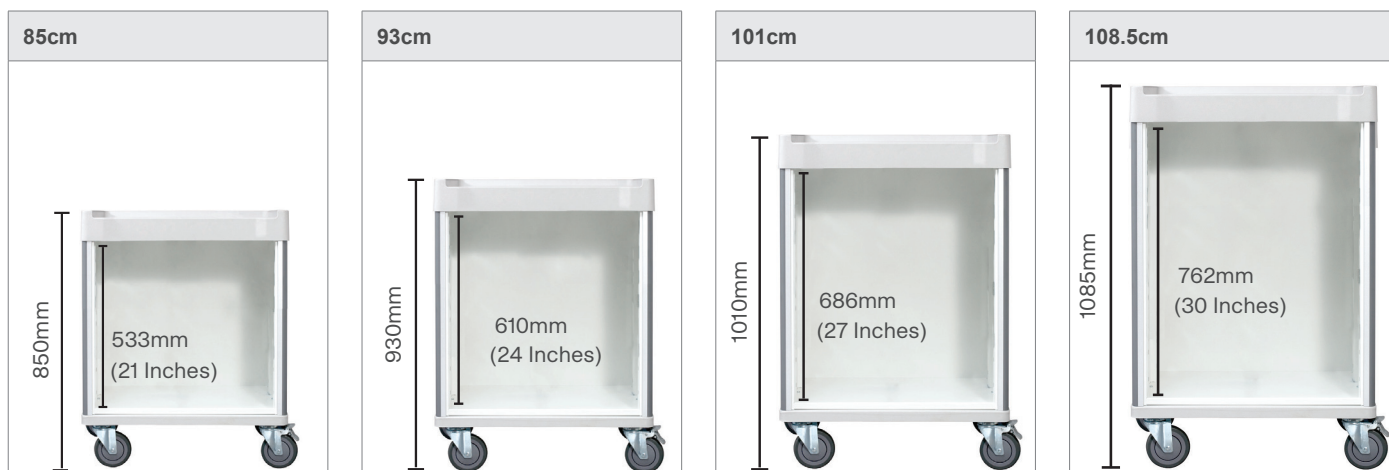

Drawer Options

A Drawer - Internal Drawer Dimensions	Width	Depth	Height
	Narrow	375mm	395mm
	Standard	565mm	395mm
	Wide	832mm	395mm
	Narrow	375mm	395mm
	Standard	565mm	395mm
	Wide	832mm	395mm
	Narrow	375mm	395mm
	Standard	565mm	395mm
	Wide	832mm	395mm

Anaesthetic Carts

Viva Anaesthetic Cart



[Watch the video here](#)

The Viva Anaesthetic Cart is designed with a combination of functions and technology specific to the needs of the anaesthesia department. This series offers a wide choice of accessories to personalise carts for every possible situation.

Features

- Top narcotics drawer with lockable lid
- ABS top with slide-out work surface
- Dividers in two drawers: 1 set for a 76mm drawer, 1 set for a 155mm drawer
- Central key lock control
- Push handle
- Multi-functional top accessories
- 4 x 125mm twin swivel castors; two locking, one directional
- Soft close drawers

GZ2640 - Optional Anaesthetic Accessories Package

- Accessory bridge supports
 - Adjustable IV Pole
 - Sharps container set
 - Tilt bin organiser - 12 small compartments
 - Tilt bin organiser - 5 large compartments
 - Glove dispenser
 - Waste container with lid
- Cart is also available without the above accessory package

Or add your own choice of accessories, see page 25



Top narcotics drawer with lockable lid.
Lid can be removed if not desired.



GC0780

GC2040

GC2030

GC2020

Code	76mm Drawer	155mm Drawer	234mm Drawer	Total Drawers	Width	Depth	Height*
GC0780	2	1	1	4	690mm	520mm	850mm
GC2040	3	1	1	5	690mm	520mm	930mm
GC2030	2	2	1	5	690mm	520mm	1010mm
GC2020	3	2	1	6	690mm	520mm	1085mm

*Height is overall including castors

Emergency Carts

Viva Paediatric Emergency Broslow Cart



- ABS top with slide-out work surface
- Drawer dividers available
- Central key lock control in addition to tab locks
- Push handle
- 4 × 125mm twin swivel castors; two locking, one directional
- Individual break-away lock or full locking bar
- Drawers: 8 × 76mm and 1 × 155mm

Code	Lock Type	Width	Depth	Height*
GC1600	Individual Break-Away	690mm	520mm	1085mm
GC1610	Full Locking Bar	690mm	520mm	1085mm

*Height is overall including castors

You can add accessories to these carts, see page 25

Emergency Carts

Viva Emergency Cart



The Viva Emergency Cart is designed with input from emergency room professionals to deliver the ultimate in convenience and safety.

These carts define a new standard of organisation and function, offering stable, smooth mobility and enhanced convenience.

Features

- ABS top with slide - out work surface
- Dividers in two drawers: 1 set for a 76mm drawer, 1 set for a 155mm drawer
- Central key lock control
- Push handle
- Break-away lock options available see page 51
- 4 x 125mm twin swivel castors; two locking, one directional
- Soft close drawers

GZ2650 - Optional Emergency Package

- Adjustable IV Pole
 - Defibrillator Shelf
 - Rotates 360°
 - Locks tight during transportation
 - CPR Cardiac board (mounted on rear of cart)
 - Easy clean polymer
 - Sharps container set
 - Oxygen tank holder with tank securing straps
- Cart is also available without the above accessory package

Or add your own choice of accessories, see page 25



GC0890 GC0900 GC2050 GC2210 GC0930

Code	76mm Drawer	155mm Drawer	234mm Drawer	Total Drawers	Width	Depth	Height*
GC0890	2	1	1	4	690mm	520mm	850mm
GC0900	3	1	1	5	690mm	520mm	930mm
GC2050	2	2	1	5	690mm	520mm	1010mm
GC2210	0	3	1	4	690mm	520mm	1010mm
GC0930	3	2	1	6	690mm	520mm	1085mm

*Height is overall including castors

Emergency Carts

Viva Narrow Emergency Cart



The Viva Narrow Emergency Cart is designed with smaller overall dimensions than the regular Emergency cart. This is ideal for areas with limited space. It provides convenient storage and easy manoeuvrability.

- ABS top with slide out work surface
- ABS Protection bumpers
- Central key lock control
- 4 x 100mm Castors; two locking, one directional
- Soft close drawers

GZ2650 – Optional Emergency accessory package (as pictured)

- Adjustable IV Pole
- Defibrillator Shelf
- CPR Cardiac board (mounted on rear of cart)
- Sharps container set
- Oxygen tank holder

Or add your own choice of accessories, see page 25

Code	76mm Drawer	155mm Drawer	234mm Drawer	Total Drawers	Width	Depth	Height*
GC2620	0	3	1	4	510mm	542mm	977mm
GC2110	2	2	1	5	510mm	542mm	977mm
GC2500	3	2	1	6	510mm	542mm	1056mm

*Height is overall including castors

GC0970 - Viva Aluminium Emergency Cart



The Aluminium Emergency Cart has many of the same features as the traditional Viva Emergency Cart, yet with sleek lines, contemporary handles and a lightweight body for a greater ease of use.

Features

- ABS top with slide out work surface
- Drawer dividers available
- Central key lock control
- Push handle
- 4 x 125mm twin swivel castors; two locking, one directional
- Soft close drawers
 - 2x 76mm, 2x 155mm, 1x 234mm
- Optional emergency accessory package GZ2650 can be added

Width	Depth	Height*	Net Weight
690mm	520mm	1010mm	46Kg

Steel cart equivalent GC2050: 64Kg

*Height is overall including castors

You can add accessories to this cart, see page 25

Procedure Carts

Viva Procedure Cart



The Viva Procedure Cart is a complete solution package suited for a wide range of functions in the healthcare environment. Some applications of the Viva Procedure Carts include:

- Medical/Surgical Wards
- Cast Rooms
- Dressing Equipment Storage
- IV Therapy
- Critical Care
- Oncology Treatment
- Trauma
- Laboratory

Features

- ABS top with slide-out work surface
- Dividers in two drawers: 1 set for a 76mm drawer, 1 set for a 155mm drawer
- Central key lock control
- Push handle
- 4 x 125mm twin swivel castors; two locking, one directional
- Soft close drawers

GZ2690 - Optional Procedure Accessory Package

- Adjustable IV Pole
- Waste container set & lid
- Multi-storage basket
- Sharps container set

Or add your own choice of accessories, see page 25



GC1650 GC1680 GC1660 GC1670

Code	76mm Drawer	155mm Drawer	234mm Drawer	Total Drawers	Width	Depth	Height*
GC1650	2	1	1	4	690mm	520mm	850mm
GC1680	1	2	1	4	690mm	520mm	930mm
GC1660	2	2	1	5	690mm	520mm	1010mm
GC1670	1	3	1	5	690mm	520mm	1085mm

*Height is overall including castors

Procedure Carts

GC1740 - Viva Aluminium Procedure Cart



The Aluminium Procedure Cart has many of the same features as the traditional Viva Procedure Cart, yet with sleek lines, contemporary handles and a lightweight body for a greater ease of use.

Features

- ABS top with slide out work surface
- Central key lock control
- Push handle
- 4 x 125mm twin swivel castors; two locking, one directional
- Soft close drawers
- Optional procedure accessory package GZ2690 can be added
Or add your own choice of accessories, see page 25

Width	Depth	Height*
690mm	520mm	1010mm

*Height is overall including castors

Viva Economy Procedure Cart



4 Drawer

- 3 x 155mm Drawers
- 1 x 234mm Drawer
- 4 x 125mm Steel Castors, 2 Locking
- Push Handle

5 Drawer

- 2 x 76mm Drawers
- 2 x 155mm Drawers
- 1 x 234mm Drawer
- 4 x 125mm Steel Castors, 2 Locking
- Push Handle

You can add accessories to these carts, see page 25

Code	Drawers	Width	Depth	Height*
GC0850	4	690mm	542mm	970mm
GC0860	5	690mm	542mm	970mm

*Height is overall including castors

GC0850



GC0860



Procedure Carts

Viva Wide Procedure Cart



- ABS top with slide - out work surface
- Central key lock control
- Push Handle
- 2 x 76mm Drawers
- 2 x 155mm Drawers
- 1 x 234mm Drawer
- 4 x 125mm twin swivel castors; two locking, one directional
- Soft close drawers

You can add accessories to this cart, see page 25

Code	76mm Drawers	155mm Drawers	234mm Drawers	Total Drawers	Width	Depth	Height*
GC2490	2	2	1	5	932mm	524mm	1010mm
GC2690	0	3	1	4	932mm	524mm	1010mm

*Height is overall including castors

GC0810 - Viva Double Medical Cart



The Double Viva Medication Cart provides large space for storage and organizes medicines easily and clearly. The key lock design secures all drawers, it also offers stable, smooth mobility and enhanced convenience with changeable accessories to meet your needs.

Features

- ABS Top
- Central key lock control
- Push handle
- 4 x 125mm twin swivel castors; two locking, one directional
- Drawer dividers available

You can add accessories to this cart, see page 25

Width	Depth	Height*
1125mm	545mm	1010mm

*Height is overall including castors

GC0815 - Viva ICU Cart



The Viva ICU Cart provides large space for storage and organises medicines and equipment easily and clearly. With a mix of open shelves for easy access and lockable drawers, it offers convenience for your needs.

Features

- ABS top with slide out work surface
- Central key lock control drawers
- Adjustable open shelves
- Push handle
- 4 x 125mm twin swivel castors; two locking, one directional

You can add accessories to this cart, see page 25

Width	Depth	Height*
1125mm	545mm	1010mm

*Height is overall including castors

Procedure Carts

Viva Mini Cart



The Viva Mini Cart is designed with smaller overall dimensions than the regular procedure cart. This is ideal for areas with limited space and those seeking a cost effective option.

Features

- ABS top
- ABS Protection bumpers
- Central key lock control
- 4 x 100mm Castors; two locking
- Dividers available



GC1450



GC1440

GC1450

GC1460



Code	76mm Drawer	155mm Drawer	234mm Drawer	Total Drawers	Width*	Depth*	Height**
GC1440	3	1	1	5	520mm	540mm	867mm
GC1450	2	2	1	5	520mm	540mm	946mm
GC1460	3	2	1	6	520mm	540mm	1025mm

*Including bumper **Height is overall including castors

Viva Narrow Cart



The Viva Narrow Cart is designed with smaller overall dimensions than the regular procedure cart. This is ideal for areas with limited space. It provides convenient storage and easy manoeuvrability.

Features

- ABS top with slide out work surface
- ABS Protection bumpers
- Central key lock control
- Push handle
- 4 x 100mm Castors; two locking
- Dividers available
- Soft close drawers

You can add accessories to these carts, see page 25



GC1500



GC1480



GC1490

Code	76mm Drawer	155mm Drawer	234mm Drawer	Total Drawers	Width*	Depth*	Height**
GC1500	1	2	1	4	520mm	542mm	900mm
GC1480	2	2	1	5	520mm	542mm	977mm
GC1490	3	2	1	6	520mm	542mm	1056mm

*Including bumper **Height is overall including castors

Procedure Carts

Viva Aluminium Narrow Cart



The Aluminium Narrow Cart has many of the same features as the traditional Viva Narrow cart, yet with sleek lines, contemporary handles and a lightweight body for a greater ease of use.

Features

- ABS top with slide out work surface
- Central key lock control
- Push handle
- 4 x 100mm twin swivel castors; two locking
- Soft close drawers

You can add accessories to these carts, see page 25

Code	76mm Drawer	155mm Drawer	234mm Drawer	Total Drawers	Width*	Depth*	Height**
GC1560	White	2	2	1	510mm	542mm	977mm
GC1540	Light Blue	2	2	1	510mm	542mm	977mm
GC1550	Pink	2	2	1	510mm	542mm	977mm
GC1530	Lavender	2	2	1	510mm	542mm	977mm

*Including bumper **Height is overall including castors

Procedure Carts

Viva Storage Cart



- ABS top with Slide out work surface
- Central key lock for drawers
- Separate Key lock for Cupboard
- Push Handle
- Adjustable shelf in cupboard space
- 4x 125mm twin swivel castors; two locking, one directional



GC1860

GC1880

GC1890

Code	76mm Drawer	Cupboard	Width	Depth	Height*
GC1860	1	1	690mm	520mm	930mm
GC1880	2	1	690mm	520mm	1010mm
GC1890	3	1	690mm	520mm	1085mm

*Height is overall including castors

GC2750 - Viva Narrow Storage Cart



- ABS top with Slide out work surface
- Central key lock for drawers
- Separate Key lock for cupboard
- Push Handle
- Adjustable shelf in cupboard space
- 4 x 100 mm twin swivel castors; two locking, one directional

Isolation Carts

Viva Isolation Cart



The bright yellow colour of the Viva Isolation Cart is synonymous with the high risk infection control areas in the facility.

Safe and dust free storage of clean gowns, caps, gloves etc provide peace of mind for staff and visitors.

Features

- ABS top with slide-out work surface
- Divider in two drawers
- Central key lock control
- Push handle
- 4 x 125mm Twin swivel castors; two locking, one directional
- Soft close drawers

GZ2680 - Optional Isolation Accessory Package

- Waste container set & lid
- Multi-storage basket
- Glove dispenser
- Cart is also available without the above accessory package

Or add your own choice of accessories, see page 25



GC1030

GC1040

GC1050

GC1060

Code	76mm Drawer	155mm Drawer	234mm Drawer	Total Drawers	Width	Depth	Height*
GC1030	1	0	2	3	690mm	520mm	850mm
GC1040	0	1	2	3	690mm	520mm	930mm
GC1050	0	0	3	3	690mm	520mm	1010mm
GC1060	1	0	3	4	690mm	520mm	1085mm

*Height is overall including castors

Medication Carts

GC1990 - Viva Medication Cart - Double Sided 4 Drawer



The Viva 4 Drawer Double Sided Medication Cart is designed to make the supply of medicine simple and efficient.

Sturdy, interchangeable drawers and dividers provide a variety of compartments which can easily accommodate medication packs of various sizes.

Features

- Drawer access on both sides
- ABS top & push handles
- Aluminium side frames
- Central key lock control
- Storage shelf
- 4 x 100mm swivel castors; two locking, one directional

You can add accessories to these carts, see page 25



ABS Bin 76mm
W112 x D215
x H76mm



ABS Bin 155mm
W112 x D215
x H155mm

Drawers	76mm Bins	155mm Bins	Width	Depth	Height*	Height (inc. push handle)
4	20	20	900mm	490mm	950mm	1090mm

*Height is overall including castors

Viva Medication Cart - Double Sided 8 and 10 Drawer



The Viva 8 & 10 Drawer Double Sided Medication Carts are designed making the supply of medicines fast and efficient.

Strong changeable drawers and dividers provide a variety of large and small spaces which can easily accommodate supplies of all sizes.

Features

- Drawer access on both sides (bin drawers only)
- ABS top & push handles
- Aluminium side frames
- Central key lock control
- 4 x 100mm swivel castors; two locking, one directional

You can add accessories to these carts, see page 25



ABS Bin 76mm
W112 x D215
x H76mm



ABS Bin 155mm
W112 x D215
x H155mm

Code	Drawers	76mm Bins	155mm Bins	234mm Drawer	Width	Depth	Height*	Height (inc. push handle)
GC2000	8	20	10	1	760mm	490mm	950mm	1090mm
GC2010	10	40	10	1	760mm	490mm	950mm	1090mm

*Height is overall including castors

Medication Carts

GC0650 - Viva 30 Dosage Medication Cart



The Viva 30 Dosage Medication Cart is double sided making the supply of medicines fast and efficient.

Features

- ABS top with slide - out work surface
- 30 x 155mm ABS Bins with acrylic divider
- 1 x 234mm Drawer
- Central key lock control
- Push Handle
- Now with 4 x dual castors: two locking, one directional

You can add accessories to these carts, see page 25



Top View



Width	Depth	Height*
690mm	540mm	1100mm

*Height is overall including castors

GC1420 - Viva Medication Cart



The Viva Medication Cart is designed to make the supply of medicines fast and efficient. The convenient drawer sizes make this a very ideal and practical option for the dispensing, storage and transportation of medication.

Features

- ABS top & push handles
- Aluminium side frames
- Central key lock control
- 2 x 76mm Drawers
- 1 x 155mm Drawer
- Storage shelf
- 4 x 100mm swivel castors; two locking, one directional
- Drawer dividers available

You can add accessories to these carts, see page 25

Width	Depth	Height* (inc. Push Handle)	Work Surface Height
900mm	490mm	930mm	800mm

*Height is overall including castors

GC1340 - Viva Medication Cart



The Viva Medication Cart is designed to make the supply of medicines fast and efficient. The convenient drawer sizes make this a very ideal and practical option for the dispensing, storage and transportation of medication.

Features

- ABS top & push handles
- Aluminium side frames
- Central key lock control
- 2 x 76mm Drawers
- 1 x 155mm Drawer
- 1 x 234mm Drawer
- 4 x 100mm swivel castors; two locking, one directional
- Drawer dividers available

You can add accessories to these carts, see page 25

Width	Depth	Height*
690mm	520mm	1010mm

*Height is overall including castors

Medication Carts

Viva Medication Cart Blue/White/Lavender



- ABS top with slide out work surface
- Central key lock control
- Push handle
- 3 x 155mm Drawers
- 1 x 234mm Drawer
- 4 x 125mm Twin swivel castors; two locking, one directional
- Soft close drawers
- Dividers in each drawer
- Also available with aluminium drawers
Code: GC1350 (Blue)

Code	Colour	Width	Depth	Height*
GC1390	Blue	690mm	520mm	1010mm
GC1410	White	690mm	520mm	1010mm
GC1400	Lavender	690mm	520mm	1010mm

*Height is overall including castors

You can add accessories to these carts, see page 25

[Watch the video here](#)

GC0690 - Viva Pre-Pack Medication Cart - Aluminium



- ABS top with slide out work surface
- Central key lock control
- Push handle
- 1 x 155mm drawer
- 2 x 260mm drawers
- 4 x 125mm swivel castors; two locking, one directional
- Soft close drawers
- Drawer dividers available

You can add accessories to this cart, see page 25

Width	Depth	Height*
690mm	520mm	1010mm

*Height is overall including castors

GC0700 - Viva Pre-Pack Medication Cart - Aluminium



- ABS top with slide out work surface
- Central key lock control
- Push handle
- 3 x 260mm drawers
- 4 x 125mm swivel castors; two locking, one directional
- Soft close drawers
- Drawer dividers available

You can add accessories to this cart, see page 25

Width	Depth	Height*
690mm	520mm	1010mm

*Height is overall including castors

Medication Carts

XGC0018 - Viva Pharmacy Sachet Cart



- ABS top with slide out work surface
- Central key lock control
- Push handle
- 6 x 76mm drawers
- 1 x 234mm drawer
- 4 x 125mm swivel castors; two locking, one directional
- Soft close drawers
- Drawer dividers available

You can add accessories to this cart, see page 25

Width	Depth	Height*
690mm	520mm	1010mm

*Height is overall including castors

Viva Stock Cart - Single



- Tray access both sides of cart
- ABS Trays 600mm x 400mm
- Dividers available
- Accommodates removable ABS trays and/or wire baskets (Total combination to equal internal height)
- Trays, baskets and dividers purchased separately (see page 30)
- 4 x 100mm swivel castors; two locking, one directional

Code	Push Handle	Width	Depth	Height*	71mm Trays	150mm Trays	Internal Height
GC1830	N/A	660mm	410mm	825mm	2	2	457mm
GC1840	Included	660mm	410mm	1070mm	2	3	610mm
GC1850	N/A	660mm	410mm	1455mm	2	6	1076mm

*Height is overall including castors

Viva Stock Cart - Double



- Tray access both sides of cart
- ABS Trays 600mm x 400mm
- Dividers available
- Accommodates removable ABS trays and/or wire baskets (Total combination to equal internal height)
- Trays, baskets and dividers purchased separately (see page 30)
- 4 x 100mm swivel castors; two locking, one directional

Code	Push Handle	Width	Depth	Height*	71mm Trays	150mm Trays	Internal Height
GC1810	N/A	895mm	610mm	665mm	4	4	457mm
GC1790	Included	895mm	610mm	915mm	4	6	610mm
GC1800	N/A	895mm	610mm	1300mm	4	12	1076mm

*Height is overall including castors

Medication Carts

Transportation Cart



Locking Bar



- Available with locking bar or shutter option
- Ideal for storage and transport of medications and supplies
- Easy close lightweight ABS shutter to protect contents during transportation
- Central key lock
- ABS top with slide out work surface
- Push handle
- Accommodates removable ABS trays and/or wire baskets (Total combination to equal internal height)
- Trays, baskets and dividers not included (see page 30)
- 4 x 125mm swivel castors; two locking, one directional

Code	Type	Width	Depth	Height*	Internal Height
GC1950	Shutter	716mm	520mm	945mm	533mm
GC1960	Shutter	716mm	520mm	1025mm	610mm
GC1970	Shutter	716mm	520mm	1105mm	686mm
GC1910	Locking Bar	716mm	520mm	945mm	533mm
GC1920	Locking Bar	716mm	520mm	1025mm	610mm
GC1930	Locking Bar	716mm	520mm	1105mm	686mm

*Height is overall including castors

IT Equipment Carts

If you are looking for something smaller than those on the next few pages, consider the [i-Move Rounds Trolleys](#).

GC0225 - Viva Hybrid Narrow Cart



The Viva Hybrid range of specialised carts assisting the secure and safe medication management of patients in the hospital, medical and other clinical environments.

Features

- ABS top with slide out work surface
- Aluminium Construction
- Central Key Lock control
- Top keyboard drawer
- 1 x 76mm Drawer
- 2 x 155mm Drawers
- 1 x 234mm Drawer
- 4 x 125mm Twin swivel castors; two locking, one directional
- Soft close drawers
- Shown with monitor & support holders (not included). Viva cart accessory options suit this cart

Width	Depth	Height*
520mm	542mm	977mm

*Height is overall including castors

You can add accessories to this cart, see page 25

IT Equipment Carts

GC1140 - IT Equipment Cart



- 4 x 100mm Swivel castors; two locking
- Aluminium mount profile
- Powder coated metal drawer/shelf
- ABS shelves and base cover
- Auto return drawer glides
- Cart weight 48kg
- Drawer load limit 10kg
- Shelf load limit 20kg
- Computer not included

Options Available

Adjustable Height Monitor Stand - Foot Operated. (GC1150)

Specifications	Width	Depth	Height*
Cart dimensions*	500mm	610mm	1350mm
Drawer dimensions 1+2	350mm	270mm	85mm
Drawer dimensions 3+4	350mm	275mm	170mm
Shelf dimensions	455mm	360mm	30mm

*Height is overall including castors

GC1130 - IT Equipment Cart



- 4 x 100mm Swivel castors; two locking
- Aluminium mount
- Powder coated metal shelves
- Powder coated steel push handle
- ABS shelves and base cover

Specifications	Width	Depth	Height*	Load Limit
Cart dimensions*	500mm	610mm	1350mm	20kg
Shelf dimensions	455mm	360mm	30mm	20kg

*Height is overall including castors

IT Equipment Cart Options suit this cart, see page 20

GC1120 - IT Equipment Cart



- 4 x 100mm Swivel castors; two locking
- Aluminium mount
- Powder coated metal drawer/shelf
- Adjustable shelves
- ABS shelves and base cover
- Auto return drawer glides
- Drawer load limit 10kg

Specifications	Width	Depth	Height*	Load Limit
Cart dimensions*	500mm	610mm	1350mm	20kg
Drawer dimensions	380mm	300mm	85mm	20kg
Shelf dimensions	455mm	360mm	30mm	20kg

*Height is overall including castors

IT Equipment Cart Options suit this cart, see page 20

I.T Equipment Carts

GC1110 - IT Equipment Cart



- 4 x 100mm Swivel castors; two locking
- Aluminium mount
- Powder coated metal drawer/shelf
- ABS shelves and base cover
- Auto return drawer glides
- Drawer load limit 10kg

IT Equipment Cart Options suit this cart, see below

Specifications	Width	Depth	Height*	Load Limit
Cart dimensions*	500mm	610mm	1350mm	20kg
Drawer dimensions	380mm	300mm	85mm	20kg
Shelf dimensions	455mm	360mm	30mm	20kg

*Height is overall including castors

IT Equipment Cart Options

GZ1970 - Probe Holder

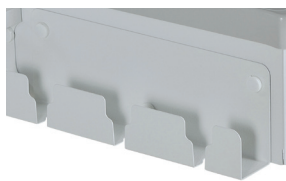

- Mounts to cabinet side
- Steel construction with powder coat finish
- Holds probes up to: Width 43 x Length 260 x Height 90mm

GZ1950 - Bottle Holder



- Mounts to cabinet side
- Steel construction with powder coat finish
- Holds bottle diameter up to: Width 54 x Length 54 x Height 89mm

GZ1990 - Basket



- Mounts to aluminium central post
- Steel construction with PVC finish
- 200 x 200 x 150mm

GZ2100 - Notebook holder



- Mounts to aluminium central post
- Aluminium construction
- Rotation 270°
- Pivot 180°
- Adjustable fixings to retain computer
- Weight capacity 8kg

GZ2090 - Monitor holder set - Short arm



- Mounts to aluminium central post
- Aluminium construction with grey painted finish
- Multi adjustable arm
- Maximum length 250mm
- Weight capacity 10kg
- Monitor not included

GZ2080 - Monitor holder set - Long arm



- Mounts to aluminium central post
- Aluminium construction with grey painted finish
- Multi adjustable arm
- Maximum length 250mm
- Weight capacity 10kg
- Monitor not included

GZ2070 - Keyboard and Mouse holder



- Mounts to aluminium central post
- Aluminium construction
- Angle adjustable
- Fits most keyboards
- Keyboard and mouse not included

GZ1980 - Push Handle

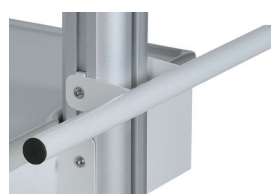

- Mounts to aluminium central post
- Steel construction with Powder coat finish
- Handle width 435mm
- Handle diameter 25mm

Service Trolleys

Service Cart - 2 Shelf



- 2 x Polypropylene shelves and handles, 4 x Aluminium frames
- 4 x 100mm Castors, 2 locking

Also Available

DB0120 Includes side panels on 3 sides (not shown)

Code	Side Panels	Tray Size	Width	*Overall Width	Depth	**Overall Height
DB0110	No	720 x 450mm	760mm	900mm	490mm	1025mm
DB0120	Yes	720 x 450mm	760mm	900mm	490mm	1025mm

*Overall width includes handles

**Height is overall including castors

Service Cart - 2 Shelf & 2 Drawers



- 2 x Polypropylene shelves and handles, 4 x Aluminium frames
- 4 x 100mm Castors, 2 locking
- 2 x Drawers W285 wide x L390mm

Also Available

DB0100 Includes side panels on 3 sides (not shown)

Code	Side Panels	Tray Size	Width	*Overall Width	Depth	**Overall Height
DB0090	No	720 x 450mm	760mm	900mm	490mm	1025mm
DB0100	Yes	720 x 450mm	760mm	900mm	490mm	1025mm

*Overall width includes handles

**Height is overall including castors

Service Trolleys

Service Cart - 3 Shelf



- 3 × Polypropylene shelves, 2 × Polypropylene handles
- 4 × Aluminium frames
- 4 × 100mm Castors, 2 locking

Also Available

DB0130 Includes side panels on 3 sides (see inset image)



Code	Side Panels	Tray Size	Width	*Overall Width	Depth	**Overall Height
DB0150	No	720 × 450mm	760mm	900mm	490mm	1040mm
DB0130	Yes	720 × 450mm	760mm	900mm	490mm	1040mm

*Overall width includes handles

**Height is overall including castors

Service Cart - 3 Shelves & 2 Drawers



- 3 × Polypropylene shelves , 2 × Polypropylene handles
- 4 × Aluminium frames
- 4 × 100mm Castors, 2 locking
- 2 × Drawers W285 wide × L 390mm

Also Available

DB0140 Includes side panels on 3 sides (not shown)

Code	Side Panels	Tray Size	Width	*Overall Width	Depth	**Overall Height
DB0160	No	720 × 450mm	760mm	900mm	490mm	1040mm
DB0140	Yes	720 × 450mm	760mm	900mm	490mm	1040mm

*Overall width includes handles

**Height is overall including castors

DB0200 - Utility Cart - 2 Shelves



- 2 × Polypropylene shelves and handles
- 4 × Aluminium frames
- 4 × 100mm Castors, 2 locking

Tray Size	Width	Depth	*Overall Height
620 × 450mm	790mm	480mm	1040mm

*Height is overall including castors

Service Trolleys

DB0190 - Utility Cart Narrow - 3 Shelves



- 3 x Polypropylene shelves , 2 x Polypropylene handles
- 4 x Aluminium frames
- 4 x 75mm Castors, 2 locking

Tray Size	Width	Depth	*Overall Height
485 x 365mm	655mm	370mm	966mm

*Height is overall including castors

DB0190 - Utility Cart Narrow - 3 Shelves



- 3 x Polypropylene shelves, 2 x Polypropylene handles
- 4 x Aluminium frames
- 4 x 100mm Castors, 2 locking

Tray Size	Width	Depth	*Overall Height
620 x 450mm	790mm	480mm	1090mm

*Height is overall including castors

Utility Cart Wide- 3 Shelves



- 3 x Polypropylene shelves
- 2 x Polypropylene handles
- 4 x Aluminium frames
- 4 x 100mm Castors, 2 locking

Also Available

DB0180 Includes side panels on 3 sides (see inset image)



Code	Side Panels	Tray Size	Width	*Overall Width	Depth	**Overall Height
DB0170	No	915 x 520mm	1100mm	520mm	1110mm	1040mm
DB0180	Yes	915 x 520mm	1100mm	520mm	1120mm	1040mm

*Overall width includes handles *Height is overall including castors

File Carts

GC2450 - Viva Narrow File Cart



The Viva Narrow File Cart is designed with smaller overall dimensions than the regular file cart. This is ideal for areas with limited space. It provides convenient storage and easy manoeuvrability.

Features

- ABS top with slide-out work surface
- ABS Protection bumpers
- Central key lock control
- 4 x 100mm Twin Wheel Castors; two locking
- 1 x 76mm Drawer
- 2 x File Drawers

Width	Depth	Height*
520mm	540mm	927mm

*Height is overall including castors

GC0300 - Open Top File Cart



The Viva top open file cart is ideal for metal hanging files. Lockable top file receptacle with a 76mm drawer and bottom file drawer make this a large capacity file cart.

Features

- Locking top slider doors
- Central Key lock control
- Push Handle
- 1 x 76mm Drawer
- 1 x File Drawer
- 4 x 125mm Castors; two locking, one directional

Width	Depth	Height*
520mm	540mm	927mm

*Height is overall including castors



GC1000 - Viva File Cart



- ABS top with slide out work surface
- Central key lock control
- Push handle
- 2 x 310mm Drawers
- 4 x 125mm Twin swivel castors; two locking, one directional
- Supplied with suspension file hanging rails
- Folders not included

Width	Depth	Height*
690mm	520mm	930mm

*Height is overall including castors



GC0990 - Viva File Cart



- ABS top with slide out work surface
- Central key lock control
- Push handle
- 400mm Lift up door with handle
- 310mm Drawer
- 4 x 125mm Twin swivel castors; two locking, one directional
- Supplied with suspension file hanging rails
- Folders not included

Width	Depth	Height*
690mm	520mm	1010mm

*Height is overall including castors



File Carts

GC1010 - File Cart



- For Binder/Folder use
- ABS top with slide out work surface
- Separate key lock control on each door
- Push handle
- 2 × 400mm Lift up door with handle
- 4 × 125mm Twin swivel castors; two locking, one directional

Width	Depth	Height*
690mm	520mm	1085mm

*Height is overall including castors

Medical Cart Accessories

GZ1600 - Adjustable IV Pole



- Fits to rear of cart
- 2 Hooks
- Easy height adjustment

GZ1370 - Defibrillator Shelf



- Rotates 360°
- Locks tight
- Fits to rear of cart
- Width: 335mm
- Length: 335-415mm

GZ1780 - Small Tilt Bin Organizer

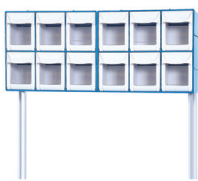

- Top accessory
- Requires accessory mount posts for mounting
- 12 Bins
- Width: 603mm
- Depth: 123mm
- Height: 153mm

GZ1770 - Large Tilt Bin Organizer

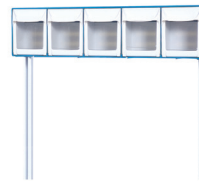

- Top accessory
- Requires accessory mount posts for mounting
- 5 bins
- Width: 603mm
- Depth: 106mm
- Height: 153mm

GZ1760 - Extra Large Tilt Bin Organizer



- Top accessory
- Requires accessory mount posts for mounting
- 4 Bins
- Width: 603mm
- Depth: 123mm
- Height: 153mm

GZ1310 - Accessory Mount Posts



- Used for mounting accessories
- Supplied as a pair
- Rear rail not included
- Rear rail code: GZ2470

GZ1320 - Bulk Storage Bins



- Requires an accessory bridge for mounting
- Set of five
- Width: 190mm
- Depth: 105mm
- Height: 75mm

GZ1581 - Hand Sanitiser Holder



- Fits to left side of Cart
- Height adjustable
- Suitable for Cutan
- Right side code GZ1581

GZ1580 - Hand Sanitiser Holder



- Fits to left side of Cart
- Height adjustable
- Suitable for Avaguard
- Right side code GZ1579

GZ1610 - Monitor Holder Long Arm



- Multi adjustable arm
- Maximum length 250mm
- Weight capacity 10kg
- Monitor not included
- Support holder not included

GZ1700 - Monitor Holder Set - Short Arm



- Rotation 270°
- Pivot 180°
- Weight capacity 8kg
- Monitor not included
- Support holder not included

JB0100 - Cantilever Monitor Arm



- Width: 413mm
- Depth: 113mm
- Height: 370mm
- Requires support holder GZ2425

Medical Cart Accessories

GZ2770 - Notebook Holder



- Mounts to right side of cart
- Steel construction with powder coat finish
- Rotation 270° and Pivot 180°
- Fixings to retain computer
- Weight capacity 8kg
- Computer not included

Support Holder for Monitor



- Mounts to accessory channel
- Left hand code GZ2420
- Right hand code GZ2430
- Cantilever monitor arm code - GZ2425

GZ1360 - Computer Drawer



- 76mm Drawer
- Computer not included
- Specify colour and size

GZ1690 - Sharps Container Set



- Side accessory includes side rail
- Width: 110mm
- Height: 215mm
- Depth: 113mm
- Includes 1.86L sharps bin

GZ0120 - Sharps Bin Bracket BD for Large Bins



- Side accessory includes side rail
- Height adjustable
- Fits:
 - BD #303209 17L one-piece
 - BD #303510 17L one-piece

GZ0130 - Sharps Bin Bracket BD for Medium Bins



- Side accessory includes side rail
- Height adjustable
- Fits:
 - BD #303207 3L one-piece
 - BD #303208 8L one-piece
 - BD #303210 8L one-piece

GZ0530 - Sharps Bin Bracket Daniels with fixing plate



- Side accessory includes side rail
- Height adjustable

GZ2740 - Sharps Bin Bracket BD for Small Bins



- Side accessory includes side rail
- Height adjustable
- Fits:
 - BD #303205, 1.4L one-piece
 - BD #305011, 1.4L temp closure
 - Terumo # BMY14SCCL, 1.4L one-piece clip lid
 - Terumo #BMY14SCSL, 1.4L one-piece screw lid

GZ1550 - Single Glove Holder



- Side accessory, includes side rail
- Width: 270mm
- Depth: 110mm
- Height: 135mm
- Gloves not included

GZ1800 - Triple Glove Holder



- Side accessory, includes side rail
- Width: 295mm
- Depth: 110mm
- Height: 360mm
- Gloves not included

GZ1330 - Catheter Holder



- Side accessory, includes side rail
- Width: 100mm
- Height: 480mm
- Depth: 100mm

DE0340 - Catheter Holder - Long



- Side accessory, includes side rail
- Width: 130mm
- Depth: 150mm
- Height: 600mm

Medical Cart Accessories

GZ1650 - Multi-storage Basket



- Side accessory, includes side rail
- Width: 330mm
- Depth: 130mm
- Height: 180mm

GZ1380 - Document Holder

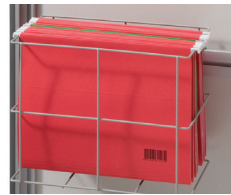

- Side accessory, includes side rail
- Width: 255mm
- Depth: 160mm
- Height: 330mm
- Files not included

GZ1520 - File Holder



- Side accessory, includes side rail
- Width: 571mm
- Depth: 397mm
- Height: 150mm

GZ1300 - Bottle Holder



- Side accessory, includes side rail
- Width: 355mm
- Depth: 95mm
- Height: 80mm

GZ1900 - Side Drawer Set



- ABS Plastic
- Width 450mm
- Depth 120mm
- Height 665mm
- To be used with 1010mm and 1085mm height carts

GZ2450 - Scope Cabinet



- Width: 1220mm
- Depth: 400mm
- Height: 155mm

GZ1660 - Oxygen Tank Holder



- The oxygen tank is fixed securely on the side with adjustable ties.
- Side accessory, includes side rail
- Width: 145mm
- Depth: 125mm
- Height: 405mm

GZ1530 - Garbage Bin



- Side accessory, includes side rail
- Width: 255mm
- Depth: 170mm
- Height: 315mm

GZ1820 - Waste Container Set & Lid



- Side accessory, includes side rail
- Width: 255mm
- Depth: 170mm
- Height: 315mm

GZ1810 - Waste Bin



- No lid
- Width: 365mm
- Depth: 255mm
- Height: 460mm
- 19L Capacity
- GZ2630 - White bracket for side rails

GZ1830 - Drop Down Side Shelf



- Width: 350mm
- Depth: 345mm
- Height: 161mm

GZ1750 - Suction Pump Holder

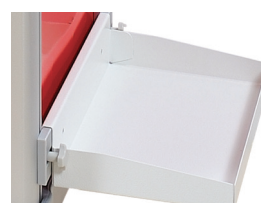

- Side accessory, includes side rail
- Width: 213mm
- Depth: 395mm
- Height: 113mm

Medical Cart Accessories

GZ1620 - Magnetic label holder



- Clear plastic front to protect label
- Length: 80mm
- Width: 50mm
- Thickness: 5mm
- Six pieces per pack
- Not suitable for aluminium drawers

GZ2580 - Tamper Proof Drawer Seals – Red



- With serial number
- 50 pieces per pack

GZ2590 - Tamper Proof Pull Tie Drawer



- With serial number
- 50 pieces per pack
- Colour Pink

GZ0500 - Single Breakaway Lock, Red



- 1st drawer locking only
- Drug and equipment security
- To be used with tamper proof seals
- Also available in Blue (GZ0510)
- Requires replacement drawer front (GZ0290)

GZ2030 - Full Length Breakaway Lock, Red for 1010mm height cart



- Full cart height - covers all drawers
- Drug and equipment security
- To be used with tamper proof seals
- Also available in Blue and White and for more cart heights
- Requires replacement drawer front (GZ0290)

GZ1440 - Drawer Divider Set – 76mm



- 3 Short dividers
- 3 Long dividers
- 2 Locating strips

GZ1500 - Drawer Divider Set – 155mm



- 2 Short dividers
- 2 Long dividers
- 2 Locating strips

GZ1510 - Adjustable Drawer Divider Set - 76mm



- 3 Short dividers
- 6 Adjustable dividers
- 6 T clips for securing dividers
- 2 Locating strips

GZ1470 - Adjustable Drawer Divider Set - 155mm



- 3 Short dividers
- 4 Adjustable dividers
- 4 T clips for securing dividers
- 2 Locating strips

GZ1400 - Adjustable Drawer Divider Set 76mm – Narrow



- For the mini, narrow and double cart range
- 3 Short dividers
- 6 Adjustable dividers
- 6 T Clips for securing dividers
- 2 Locating strips

GZ1430 - Adjustable Drawer Divider Set 155mm – Narrow



- For the mini, narrow and double cart range
- 3 Short dividers
- 4 Adjustable dividers
- 4 T Clips for securing dividers
- 2 Locating strips

GZ1260 - Adjustable Divider - 76mm

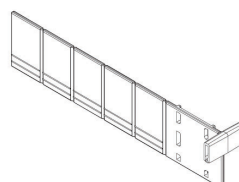

- Width: 51mm
- Length: 237mm
- To suit 76mm drawer

Medical Cart Accessories

GZ1180 - Adjustable Divider - 155mm

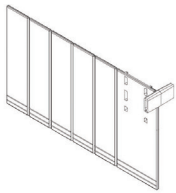

- Width: 130mm
- Length: 237mm
- To suit 155mm drawer

GZ1210 - Drawer Divider - 76mm short

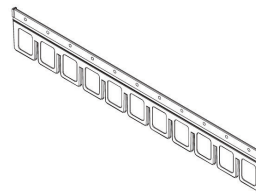

- Width: 51mm
- Length: 368mm
- To suit 76mm drawer

GZ1240 - Drawer Divider - 155mm short

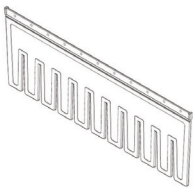

- Width: 130mm
- Length: 368mm
- To suit 155mm drawer

GZ1200 - Drawer Divider - 76mm long

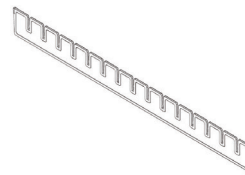

- Width: 51mm
- Length: 542mm
- To suit 76mm drawer

GZ1230 - Drawer Divider - 155mm long

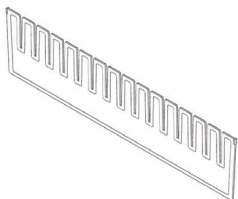

- Width: 130mm
- Length: 542mm
- To suit 155mm drawer

GZ0860 - T clips in AS material

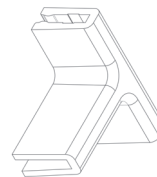

- 10 pieces per pack
- Retains adjustable dividers

GZ1350 - Label Holder - Clip on

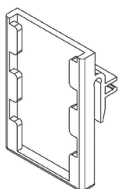

- Clips onto dividers, ABS tray and wire basket
- 20 pieces per pack
- Width: 40mm
- Depth: 18mm
- Height: 60mm

GZ1220 - Wire Basket for Stock / Transport Carts

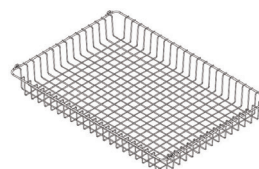

- Width: 600mm
- Length: 400mm
- Height: 70mm

GZ1250 - Wire Basket for Stock / Transport Carts



- Width: 600mm
- Length: 400mm
- Height: 148mm

GZ1280 - Wire Basket for Stock / Transport Carts



- Width: 600mm
- Length: 400mm
- Height: 226mm

GZ1740 - ABS Trays for Stock / Transport Carts - Small

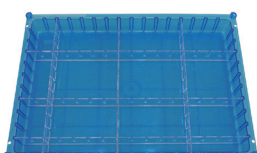

- Width: 600mm
- Length: 400mm
- Height: 71mm

GZ1730 - ABS Trays for Stock Transport Carts - Large

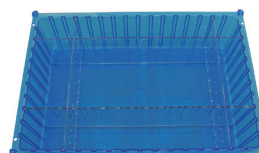

- Width: 600mm
- Length: 400mm
- Height: 150mm

Medical Cart Accessories

GZ1460 - Tray Divider for ABS Trays - Small

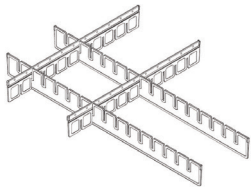

- 3 Short
- 3 Long

GZ1450 - Tray Divider for ABS Trays - Large

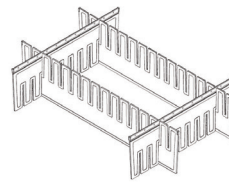

- 2 Short
- 2 Long

GZ1490 - Adjustable Tray Divider for ABS Trays - Small

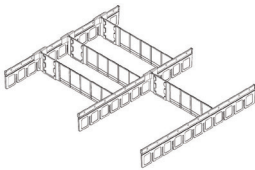

- 3 Short
- 6 Adjustable
- 6 T clips for secure dividers

GZ2440 - Outdoor Push Handle



- Width: 454mm
- Depth: 203mm
- Height: 352mm

GZ0230 - All Terrain Base



- Width: 794mm
- Depth: 588mm
- Height: 300mm
- Wheels: 200mm, 2x lockable

GZ1540 - Garden Scene Sticker Set



- Can be applied to any Viva Cart at time of order

GZ1680 - Sea Scene Sticker Set



- Can be applied to any Viva Cart at time of order

Red Signline Option



- Coloured signline to identify cart functions or location

Blue Signline Option



- Coloured signline to identify cart functions or location

Yellow Signline Option



- Coloured signline to identify cart functions or location

Grey Signline Option



- Coloured signline to identify cart functions or location

GZ1850 - CPR Cardiac Board



Macromolecular polymer CPR Board, strong and easy to clean

- Width: 440mm
- Height: 510mm
- Thickness: 10mm

Also Available GZ1590 Hanging Hooks for non-emergency carts