

PRO-MED



Magen, Darm, Rectum
Leber, Galle, Niere
Urologie
Gynäkologie, Geburtshilfe

Stomach, Intestines, Rectum
Liver, Gall, Kidney
Urology
Gynecology, Obstetrics

Estomac, Intestines, Rectum
Foie, Bile, Reins
Urologie
Gynécologie, Accouchement

Estómago, Intestinos, Recto
Hígado, Bilis, Riñón
Urología
Ginecología, Obstetricia

Stomaco, Intestini, Retto
Fegato, Bile, Reni
Urologia
Ginecologia, Ostetricia

PRO-MED

Dieser Katalog bleibt unser ausschließliches Eigentum.
Unsere „Allgemeinen Lieferungs- und Zahlungsbedingungen“ finden Sie auf unserer Internetseite
www.pro-med-tut.com
Nachdruck, auch auszugsweise, ist ohne unser schriftliches Einverständnis verboten.

This catalogue remains our exclusive property.
Our “General Terms of Sale and Payment” may be found on our homepage
www.pro-med-tut.com
Reprinting, even partially, is prohibited without our written consent.

Ce catalogue est exclusivement notre propriété.
Nos “Conditions générales du vente et de paiement” sont mentionnées sur l’Internet à
www.pro-med-tut.com
Toute representation ou reproduction intégrale ou partielle – faite sans l’autorisation écrite de la Société **PRO-MED** est interdite.

Este catálogo es exclusivamente de nuestra propiedad.
Nuestros condiciones generales de venta y de pago se encuentran en nuestra página Internet
www.pro-med-tut.com
Reimpresión, aunque sea parcialmente, queda terminantemente prohibida.

Il presente catalogo rimane di nostra proprietà.
Le nostre condizioni di vendita e di pagamento le trovo sul nostro sito Internet
www.pro-med-tut.com
La riproduzione del catalogo è proibita.

Modelländerungen vorbehalten
Patterns are subject to change.
Tous droits réservés des changements de modèle.
Salvo modificaciones.
Ci riserviamo la facoltà di cambiamenti nei modelli



PRO-MED

INSTRUMENTE GMBH

INT / URO / GYN / OB

Garantierte Qualitätsinstrumente

Guaranteed Quality Instruments

Instruments de Chirurgie de qualité garantie

Instrumentos de Calidad con garantia

Strumenti di chirurgia con qualità garantita

PRO-MED

Instrumente GmbH
Gänsäcker 9
D-78532 TUTTLINGEN
Germany

Telephone +49(0) 74 62 / 20 42 40
Telefax +49(0) 74 62 / 20 42 49 0
E-Mail pro-med-tut@t-online.de
Internet www.pro-med-tut.com

PRO-MED

Qualität ist eine Frage des
Anspruchs ...

Quality is a question of demand ...

La qualité est une question
d'exigence ...

Calidad es la pregunta de
pretension ...

Qualità è una domanda di pretesa...

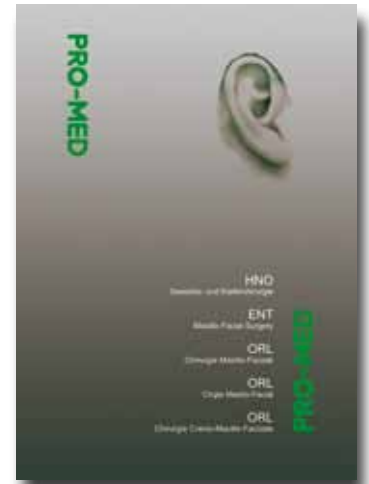
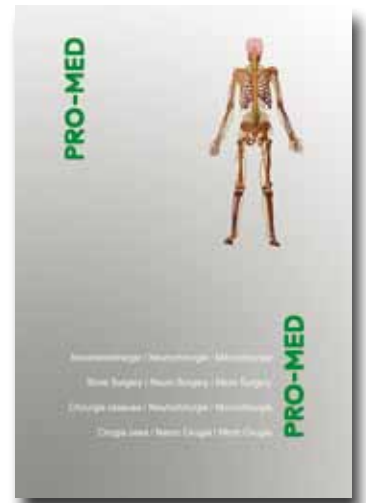
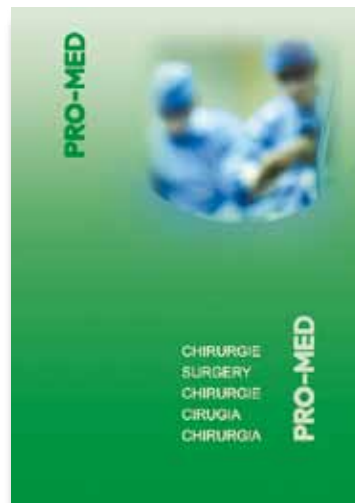

Unsere Kataloge
Our Catalogs
Nos catalogues
Nuestros catálogos
I nostri cataloghi

Chirurgie / Surgery / Chirurgie / Cirugia / Chirurgia
Ortho / Neuro / Micro
Thorax / Cardiovascular
INT / URO / GYN / OB
HNO / ENT / ORL





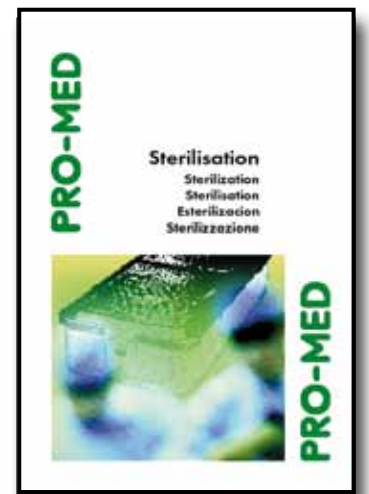





Bariatrische Chirurgie / Bariatric Surgery / Chirurgie bariatrique /
Cirugia Bariátrica / Chirurgia Bariátrica

Sterilisation / Sterilization / Stérilisation / Esterilización / Sterilizzazione





**ÜBERSICHTSTAFEL
SECTION INDEX
SOMMAIRE
CONTENU
INDICE DI CATALOGO**

**SEITE
PAGE
PAGE
PAGINA
PAGINA**

<p>DIAGNOSTIK DIAGNOSTICS DIAGNOSTIC DOAGNOSTICO DIAGNOSTICA</p>		7-15,195-198
<p>VERGLEICH SINSTRUMENTE COMPARING INSTRUMENTS INSTRUMENTS A COMPARISON INSTRUMENTOS PARA COMPARICION STRUMENTI DI PARAGONE</p>		17-20
<p>VORBEREITUNG, DERMATOLOGIE, HYGIENE PREPARATION, DERMATOLOGY, HYGIENE PREPARATION, DERMATOLOGIE, HYGIENE PREPARACION, DERMATOLOGIA, HIGIENE PREPARAZIONE, DERMATOLOGIA, IGIENE</p>		21-24
<p>MAGEN, DARM, MASTDARM STOMACH, INTESTINES, RECTUM ESTOMAC, INTESTINS, RECTUM ESTOMAGO, INTESTINOS, RECTO STOMACO, INTESTINI, RETTO</p>		25-71
<p>GALLE, LEBER, NIERE GALL, LIVER, KIDNEY BILE, FOIE, REIN BILIS, HIGADO, RINON BILE, REGATO, RENE</p>		73-92
<p>UROLOGIE UROLOGY UROLOGIE ROLOGIA UROLOGIA</p>		93-104
<p>GYNÄKOLOGIE GYNECOLOGY GYNECOLOGIE GINECOLOGIA GINECOLOGIA</p>		105-173
<p>GEBURTSHILFE OBSTETRICS OBSTETRIQUE OBSTETRICIA OSTETRICIA</p>		175-191
<p>ALLGEMEINE INSTRUMENTE GENERAL INSTRUMENTS INSTRUMENTS GENERAUC INSTRUMENTOS GENERALES STRUMENTI GENERALI</p>		193-371
<p>SKALPELLGRIFFE, KLINGEN SCALPEL BLADES, HANDLES LAMES DE BISTOURIS, MANCHES HOJAS DE BISTURIS, MANGOS LAME PER BISTURI, MANICI</p>		199-205
<p>SCHEREN SCISSORS CISEAUX TIJERAS FORBICI</p>		207-232

**ÜBERSICHTSTAFEL
SECTION INDEX
SOMMAIRE
CONTENU
INDICE DI CATALOGO**

**SEITE
PAGE
PAGE
PAGINA
PAGINA**

PINZETTEN FORCEPS PINCES PINZAS PINZETTEN		233-266
ARTERIENKLEMMEN HEMOSTATIC FORCEPS PINCES HEMOSTATIQUES PINZAS HEMOSTATICAS PINZE EMOSTATICHE		267-293
TUCHKLEMMEN, SCHLAUCHKLEMMEN, TUPERZANGEN TOWEL- AND TUBING CLAMPS, DRESSING- AND SPONGE FORCEPS PINCES A CHAMPS, PRESSE-TUBES, ET TAMPONS PINZAS DE CAMPO, PARA TUBOS Y TAMPONES PINZE FISSATELLI, PINZE SERRATUBI, PINZE PER TAMPONI		295-304
WUNDHAKEN RETRACTORS ECARTEURS SEPARADORES DIVARICATORI		305-317
WUNDSPREIZER SELF-RETAINING RETRACTORS ECARTEURS AUTOSTATIQUES SEPARADORES AUTOSTATICOS DIVARICATORI AUTOSTATICI		319-341
NAHT SUTURE SUTURE SUTURA SUTURA		343-361
SONDEN, SAUGROHRE, TROKARE PROBES, ASPIRATION, TROCARS STYLETS, ASPIRATION, TROCARTS ESTILETES, ASPIRACION, TROCARES SPECILLI, ASPIRAZIONE, TREQUARTI		363-371
STERILISATION, VERSCHIEDENES STERILIZATION, MISCELLANEOUS STERILISATION, ARTICLES DIVERS ESTERILIZACION, DIVERSOS ARTICULOS STERILIZZAZIONE, DIVERSOS ARTICOLI		373-395
ALPHABEBISCHER INDEX ALPHABETICAL INDEX INDEX ALPHABETIQUE INDICE ALFABETICO INDICE ALFABETICO		397-435
NUMERISCHER INDEX NUMERICAL INDEX INDEX NUMERIQUE IINDICE NUMERICO INDICE NUMERICO		437-448

DIAGNOSTIK
DIAGNOSTICS
DIAGNOSTIC
DIAGNÓSTICO
DIAGNOSTICA



Blutdruckmesser
Blood Pressure Manometers
Tensiomètres
Sfigmanometros
Sfigmanometri



10.0010 NOVA-PRESAMETER

Quecksilbergerät in Metalletui. Skala bis 300 mm Hg. Fehlertoleranz: +/- 3 mm Hg. Kalibrierte Velcromanschette mit Latexpolster 2-Schlauch.

Mercurial sphygmomanometer in metal case. Graduated scale; maximum reading 300 mm Hg. Maximum error throughout range +/- 3 mm Hg. Calibrated nylon velcro cuff with 2-tube latex bladder.

Appareil à colonne de mercure en boîtier métallique. Echelle anodisée jusqu'à 300 mm Hg. Tolérance maximale +/- 3 mm Hg. Avec brassard nylon-velcro, calibré, et vessie latex à 2 tubes.

Tensiómetro de mercurio en estuche metálico. Escala anodizada hasta 300 mm Hg. Tolerancia max +/- 3 mm Hg. Brazaletes velcro de nilon, calibrado, con bolsa latex de 2 tubos

Sfigmanometro in astuccio metallo, Scala 0 - 300 mmHg. Tolleranza +/- 3 mmHg. Bracciale calibrato velcro-nylon di camera d'aria di latex a 2-tubi.



10.0020 PRECISA N

Manometer-Blutdruckmessgerät; ergonomischer Löffelgriff; Lineare Skale 0 - 300 mm Hg; maximale Fehlertoleranz +/- 3 mmHg

Blood Pressure Manometer; Ergonomic spoon-shaped grip; linear, tilted aluminum scale from 0 to 300 mm Hg; max. error tolerance +/- 3 mmHg

Tensiomètre à cadran; poignée-cuiller ergonomique; graduation linéaire inclinée, de 0 à 300 mm Hg; tolérance max. d'erreur +/- 3 mmHg

Tensiómetro aneroides; Mango de cuchara ergonómico; Escala de aluminio lineal, inclinada, 0 - 300 mmHg; Máxima tolerancia de error de +/- 3 mmHg

Sfigmanometro moderno e economico. Scala 0 - 300 mmHg, 53 mm Ø. Valore massimo 300 mmHg. Tolleranza +/- 3 mmHg. Bracciale calibrato velcro-nylon di camera d'aria di latex a 1 tubo

Blutdruckmesser
Blood Pressure Manometers
Tensiomètres
Sfigmanómetros
Sfigmanometri



10.0030 MINIMUS II

Einhandmodell in Vinyltasche mit Reißverschluss. Keine Nullpunktfixierung. Gut ablesbare Aluminiumskala Ø 49 mm bis 300 mm Hg. Maximale Fehlertoleranz +/- 3 mm Hg. Mit kalibrierter Nylon-Velcromanschette komplett mit Latexpolster 1-Schlauch.

Palm-style sphygmomanometer in vinyl zipper case. Graduated aluminum scale Ø 49 mm. Maximum reading 300 mm Hg. Maximum error +/- 3 mm Hg. With calibrated nylon-velcro cuff and 1-tube latex bladder.

Manopoire en étui vinyl avec fermeture éclair. Echelle Ø 49 mm jusqu'à 300 mm Hg. Tolérance maximale +/- 3 mm Hg. Avec brassard nylon-velcro calibré, et vessie latex à 1 tube.

Modelo de mano. Lectura de la escala Ø 49 mm hasta 300 mm Hg. Tolerancia max. +/- 3 mm Hg. Brazaletes velcro de nilón, calibrado; cámara d'aria de latex ad 1 tubo.

Sfigmanometro ad aneroide in borsa vinilpelle con cerniera lampo. Senza fissaggio a zero. Scala graduata in alluminio 49 mm Ø, 0 - 300 mmHg. Tolleranza +/- 3 mmHg. Bracciale calibrato velcro-nylon di camera d'aria di latex a 1 tubo



10.0040 EXACTA

Hochleistungs-Blutdruckmessgerät in 2-Schlauch-Ausführung. Lineare Skala Ø 40 mm, von 0 - 300 mm Hg; max. Fehlertoleranz +/- 3 mmHg

High quality Sphygmomanometer in a 2-tube version; Linear scale Ø 49 mm, 0 - 300 mmHg; Max. error tolerance +/- 3 mmHg

Tensiomètre à cadran de haute qualité à 2 tubes; Graduation linéaire, Ø 49 mm de 0 à 300 mmHg; tolérance max. d'erreur de +/- 3 mmHg

Tensiómetro de precisión de alta calidad, con 2 tubos; Escala lineal Ø 49 mm, 0 - 300 mmHg; Máxima tolerancia de error de +/- 3 mmHg

Sfigmanometro di alta prestazione. Scasla lineare 0 - 300 mmHg, 49 mm Ø. Tolleranza +/- 3 mmHg. Bracciale calibrato velcro-nylon di camera d'aria di latex a 2 tubi



kalibrierte Nylon-Velcromanschetten, 2-Schlauch
Calibrated nylon-velcro cuffs 2-tube
Brassards nylon-velcro calibré avec 2-tubes
Brazeletes velcro de nilón con 2 tubos
Bracciali velcro solo a 2 tubi

10.0080

für Erwachsene / for adults / pour adultes / para adultos / per adulti

10.0081

für Erwachsene (dünne Arme) / for adults (thin arms) / pour adultes (bras minces) / para adultos (brazos delgados) per adulti (braccie fine)

10.0082

für Oberschenkel /for femur / pour fémur / para muslo / per coscie

10.0083

für Neugeborene / for newborn / p. nouveaux-nés / p. racien nacidas / per neonato

10.0084

für Säuglinge / for Infants / pour bébés / p. lactantes / per lattante

10.0085

für Kinder / for children / pour enfants / para niños / per bambini

kalibrierte Nylon-Velcromanschetten, 1-Schlauch
Calibrated nylon-velcro cuffs 1-tube
Brassards nylon-velcro calibré avec 1-tube
Brazeletes velcro de nilón con 1 tubo
Bracciali velcro solo a 1 tubo

10.0090

für Erwachsene / for adults / pour adultes / para adultos / per adulti

10.0091

für Erwachsene (dünne Arme) / for adults (thin arms) / pour adultes (bras minces) / para adultos (brazos delgados) per adulti (braccie fine)

10.0092

für Oberschenkel /for femur / pour fémur / para muslo / per coscie

10.0094

für Neugeborene / for newborn / p. nouveaux-nés / p. racien nacidas / per neonato

10.0095

für Kinder / for children / pour enfants / para niños / per bambini

Stethoskope
Stethoscopes
Stéthoscopes
Estetoscopios
Stetoscopi



aus Aluminium
of aluminium
de aluminium
de aluminio
in alluminio

PINARD
10.0400
15 cm

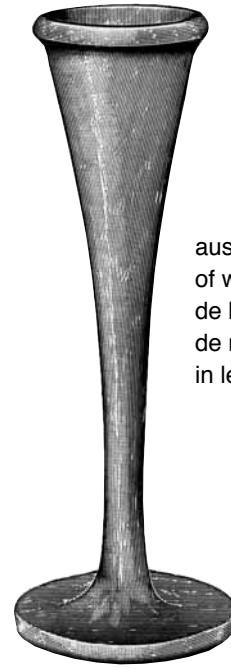

aus Holz
of wood
de bois
de madera
in legno

PINARD
10.0410
18 cm



DUPLEX
10.0460



DUPLEX DE LUXE
10.0462

OCULUS Binokulare Kopflupe OCULUS Binocular Magnifying Loupe OCULUS Loupe binoculaire frontale OCULUS Lupa frontal binocular OCULUS Lente binoccolare frontale	Vergrößerung magnification grossissement aumento Ingrandimento	Arbeitsabstand working distance distance de travail distancia de trabajo distanza di osservazione	Arbeitsfeld working field champ visuel campo de visión campo visivo
 <p>28.7050 OCULUS Lupenbrille mit Gestell / binocular loupe with frame loupe binoculaire avec monture / lupa binocular con montura/ Occhiali a lenti binoculari</p>	1,8X	370 mm	90 mm
 <p>28.7055 OCULUS Lupe allein / magnifying loupe only loupe seule / lente de aumento suelta / Lente sola</p>	1,8X	370 mm	90 mm
<p>28.7057 OCULUS Vorsatzobjektive 2,0X zur Montage an 1,8X slip-on objectives to increase 1,8X to 2,0X loupes additionnelles de 1,8X à 2,0X lentes adicionales de 1,8X a 2,0X 2 lenti addizionali, ingrandimento 2,0 x</p> 	2,0X	220 mm	50 mm
<p>28.7058 OCULUS Vorsatzobjektive 2,5X zur Montage an 1,8X slip-on objectives to increase 1,8X to 2,5X loupes additionnelles de 1,8X à 2,5X lentes adicionales de 1,8X a 2,5X 2 lenti addizionali, ingrandimento 2,5 x</p> 	2,5X	180 mm	45 mm
<p>28.7059 OCULUS Etui alleine / case only / etui seule / estuche suelto / Astucchio solo</p>			

Stirnspiegel und -lampen
Head Mirrors and Lights
Mirroirs frontaux
Espejos frontales
Specchi frontali



ZIEGLER
10.0700
compl.



ZIEGLER
10.0709



10.0707

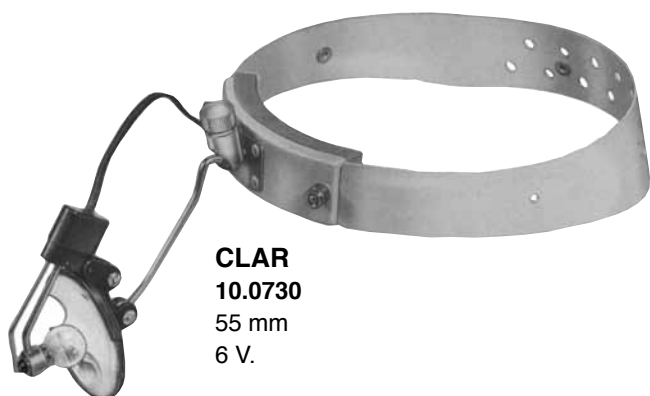

CLAR
10.0730
55 mm
6 V.

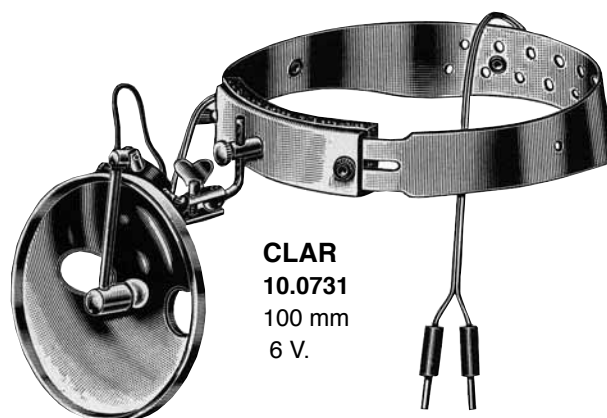

CLAR
10.0731
100 mm
6 V.

Klein-Transformator 220 Volt, stufenlos regulierbar von 0-10 Volt
Mini-Transformer 220 Volts, infinitely variable from 0-10 Volts
Transformateur, petit modèle, de 220 Volts, réglable sans paliers de 0 à 10 Volts
Transformador pequeño 220 voltios, con regulación continua de 0 a 10 voltios
Trasformatore piccolo, 220 Volt, regolazione continua da 0 a 10 Volt



CLAR
10.0737



CLAR
10.0739 6 V.



10.0750



10.0760
FOCUS Halogen-Stirnlampe 220 V.
Halogen-Headlight 230 V.
Lampe frontale halogène 230 V.
Lámpara frontal halógeno 230 V.
lampada frontale alogena, 230 V.



10.0762
FOCUS Lampenkopf mit Sockel und Halogenlampe
Lamp head with quick lock and halogen light
Tête de lampe avec socle et lampe halogène
Cabeza de lámpara con zócalo y lámpara de halógeno
Testa de lampada con base e lampada alogena

10.0761
FOCUS Stirnband mit Kabel
Headband with cable
Bandeau frontal avec cordon d'alimentation
Cinta de frente con cable
Fascia frontale con cavo

10.0763
FOCUS Trafo m.Kabel u.Stufenschalter 230 V
Plug-in charger with cable and switch 230 V
Transformateur avec cordon d'alimentation et commutateur
pas-en-pàs 230 V.
Transformador con cable y conmutador de dos posiciones 230 V.
Transformatore con cavo e interruttore di 2 regolazioni 230 V.

10.0769
FOCUS Halogen Ersatzlampe 8 V. für Stirnlampe
Halogen Spare bulb 8 V. for headlight
Lampe de rechange halogène 8 V. pour lampe frontal
Lámpara de repuesto halógeno 8 V. para lampara frontal
Lampadina di ricambio 8 V. per lampada frontale

10.0790
CLAR Stirnspiegel Ø 33 mm KALTLICHT mitverstellbarem
Kopfband , 220 cm Lichtkabel, Anschlüsse for Wolf & Storz
CLAR Headmirror Ø 33 mm FIBER OPTIC with adjustable
headband, 220 cm Fibre Optic cable and Wolf & Storz
connectors
CLAR Miroir frontal Ø 33 mm à lumière froide avec bandeau
frontal, 220cm câble à lumière froide, connecteurs Wolf &
Storz,
CLAR Espejo frontal Ø 33 mm luz fria con cinta ajustable, 220
cm cable luz fria, connexion Wolf & Storz
CLAR Specchio frontale Ø 33mm LUCE FREDDO con fascia
regolabile, 220 cm cavo conduttore, arracco Wolf & Storz



10.2000
Kaltlichtquelle Halogen HL 150W, 230 V, B 175 x H 82,5 x T 202mm.
Schutzklasse BF
Halogen Cold Light Projector HL 150, 230V, Size 175 x 82,5 x 202mm,
Protective Class BF
Dispositif à lumière froide Halogène, HL 150W, 230 V, 175 x 82,5 x 202mm;
Classe de protection BF
Proyector halógeno de luz fria HL 150W 230 V, 175 x 82,5 x 202mm,
Clase de protección BF
Proiettore Luce Fredda Alogeno HL 150W 230 V.; 175 x 82,5 202 mm;
classificazione di protezione BF



VERGLEICHSTRUMENTE
COMPARING INSTRUMENTS
INSTRUMENTS A COMPARISON
INSTRUMENTOS PARA COMPARACION
STRUMENTI DI PARAGONE



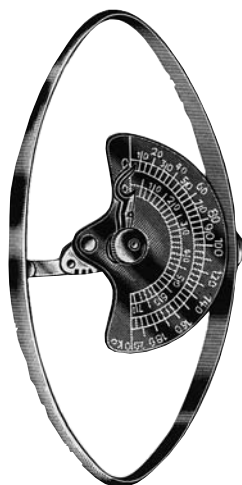

COLLIN
10.0300

Dynamometer
Dynamometer
Dynamomètre
Dinamómetro
Dinamometro



10.0331 **10.0322** **10.0333** **10.0334** **10.0335**
10 cm / 4" 15 cm / 6" 20 cm / 8" 30 cm / 12" 50 cm / 20"

Metal-Maßstäbe / Metal Rulers /
Règles, en métal / Reglas de metal /
Reguli di acciaio



Maßband, Leinen
Tape measure, Linen
Ruban métrique en toile
Cinta métrica de tela
Nastro metrico di tela
10.0350
1,5 m

Maßband, Stahl
Tape measure, steel
Ruban métrique en acier
Cinta métrica de acero
Nastro metrico metallico
10.0352
2 m

Beckenzirkel
Pevimeters
Pelvimètres
Pelvimetros
Pelvimetri



MARTIN
56.0010

30 cm
cm/Zoll-Skala / cm/inch scale /
échelle en cm/pouces / escala en
cm/pulg. / scala in cm/pollici



COLLIER
56.0020

30 cm
cm/Zoll-Skala / cm/inch scale /
échelle en cm / pouces / escala
en cm/pulg. / scala in cm/pollici

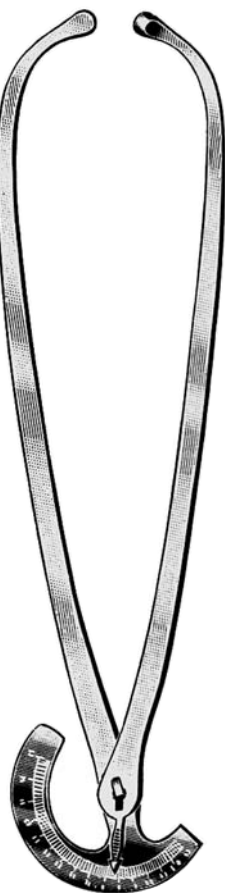

COLLIN
56.0030

35 cm
cm Skala / cm scale / échelle en
cm / escala en cm / scala in cm

VORBEREITUNG, DERMATOLOGIE
PREPARATION, DERMATOLOGY
PREPARATION, DERMATOLOGIE
PREPARACION, DERMATOLOGIA
PREPARAZIONE, DERMATOLOGIA



Maniküre, Pedicure / Manicure, Pedicure / Manicure, Pédicure / Manicura, Pedicura / Manicure, Pedicure

Nagelzangen / Nail Nippers / Pinces à ongles / Pinzas corta-uñas / Tonchesine per unghie 14 cm



58.0501
14 cm



TURNBULL
58.0520 11,5 cm
58.0522 13,5 cm



58.0530
14 cm

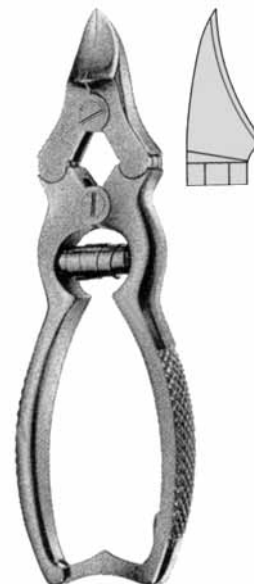

58.0540
15 cm



58.0550
13 cm



LITTAUER
58.0551 11 cm
58.0553 13 cm
58.0555 15 cm

Nagelhaut- und Nagelscheren / Cuticle- and Nail Scissors /
 Ciseaux à envies et à ongles / Tijeras cuticulares y para uñas /
 Forbici per la cuticula e unghie

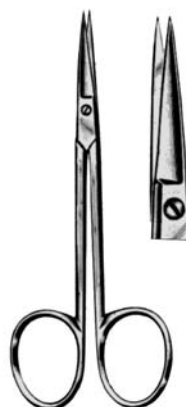

58.0600
10 cm

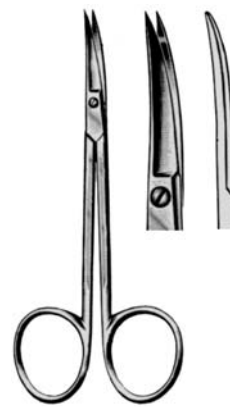

58.0601
10 cm

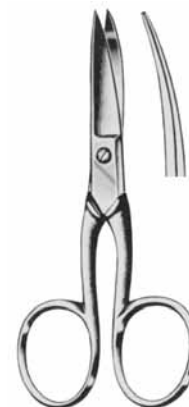

58.0621
10 cm

Schwesterngarnitur / Nurses' Set /
Etui pour infirmières / Surtido para enfermeras /
Necessario per infermiera

Nagelfeilen / Nail-files / Limes à ongles / Limas de uñas / Lime per le unghie



58.0700



58.0710
10 cm



58.0712
12 cm



58.0715
15 cm

Bürstenspender für 20 Bürsten / Dispensers for 20 brushes /
Distributeurs pour 20 brosses / Dispensadores para 20 cepillos
/ Dispenser per 20 spazzole

Handwaschbürste / Nail Brush / Brosse à main /
Cepillo a mano / Spazzola a mano



- 58.1000** SILBER / SILVER / ARGENTE / PLATEADO / ARGENTEO
- 58.1001** BLAU / BLUE / BLEU / AZUL / AZZURO
- 58.1002** ROT / RED / ROUGE / ROJO / ROSSO
- 58.1003** GRÜN / GREEN / VERT / VERDE / VERDE
- 58.1004** GOLD / GOLD / DORE / DORADO / D'ORO



58.1040

MAGEN, DARM, MASTDARM
STOMACH, INTESTINES, RECTUM
ESTOMAC, INTESTINS, RECTUM
ESTÓMAGO, INTESTINOS, RECTO
STOMACO, INTESTINI, RETTO



Empfohlene Operationsbestecke für den Bereich "MAGEN, DARM, MASTDARM"
(Details erhalten Sie über Ihren Fachhändler)

Suggested Instrument Sets for „STOMACH, INTESTINES, RECTUM“
(Please ask your dealer for details)

Suggestions de boîtes opératoires pour le secteur „ESTOMAC, INTESTINS, RECTUM“.
(Pour plus de détails veuillez contacter votre distributeur.)

Cajas quirurgicas para "ESTOMAGO, INTESTINOS, RECTO" (para detalles póngase en contacto con su distribuidor)

Strumentari raccomandati per "LO STOMACO, L'INTESTINALE, L'INTESTINO RETTO"
(Per ulteriori informazioni, vi preghiamo di contattare il Vostro rivenditore)

SET 48.0100 Gastrointestinal Operating Set

SET 48.0200 Gastrectomy Set

SET 48.0300 Intestinal Operating Set

SET 48.0400 Colostomy Set

SET 48.0500 Perineal Resection Set

SET 48.0600 Vagotomy Set

SET 48.1000 Major Rectal Instrument Set

SET 48.1200 Anal Set

SET 48.2000 Proctology Set

SET 48.2100 Haemorrhoidectomy Set

SET 48.2200 Rubber Band Ligation Set

SET 48.2300 Anal Fistulectomy Set

SET 48.2400 Pilonidal Cyst Excision Set

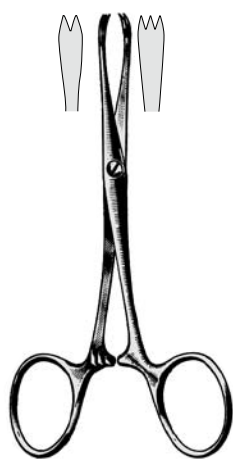

CHAPUT
 15.1200 12 cm



TUFFIER
 15.1204 13 cm



15.1270
 15,5 cm



15.1272
 20 cm



PENNINGTON
 15.1300 15 cm
 15.1302 20 cm



ALLIS-BABY
 48.0004 13 cm, 4 x 5
 48.0006 14 cm, 4 x 5

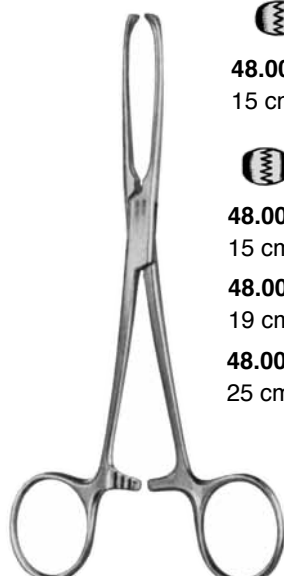

ALLIS

48.0010
 15 cm, 4 x 5



48.0011
 15 cm, 5 x 6

48.0014
 19 cm, 5 x 6

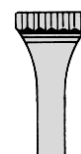
48.0016
 25 cm, 5 x 6

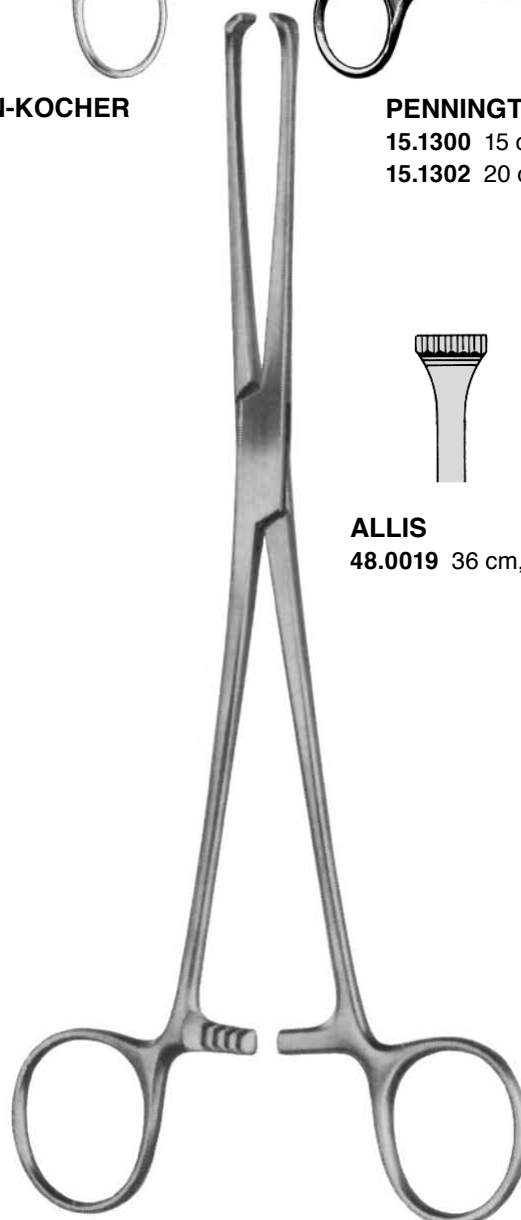

ALLIS
 48.0019 36 cm, 5 x 6



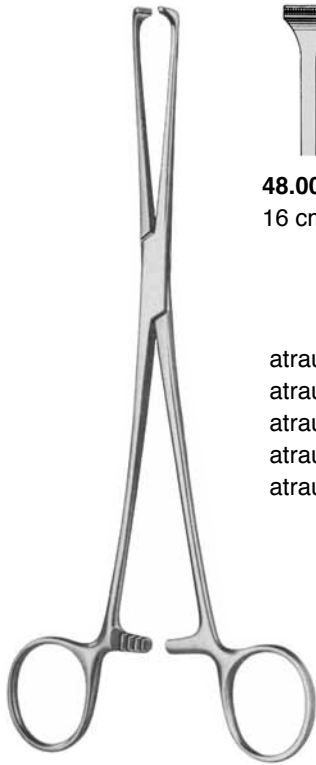

ALLIS

48.0020
16 cm

atraumatisch
 atraumatic
 atraumatique
 atraumática
 atraumatiche

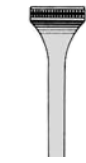

48.0024
20 cm



48.0028
25 cm



48.0029
30 cm



ALLIS-ADAIR
48.0030 15,5 cm



JUDD-ALLIS
48.0032 15 cm
48.0034 19 cm
3 x 4

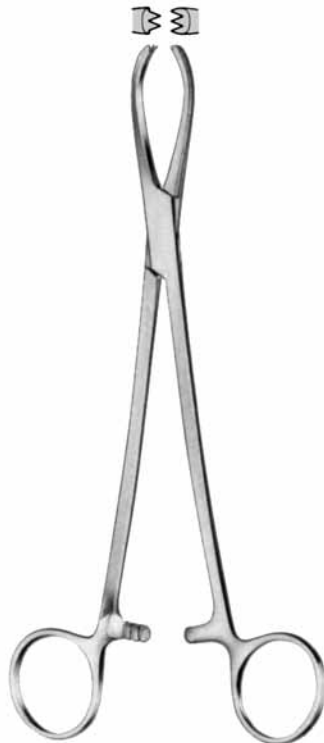

LITTLEWOOD
48.0035 19 cm
2 x 3



BOYS-ALLIS
48.0036 15 cm



THOMS-ALLIS
48.0038 20 cm
6 x 7

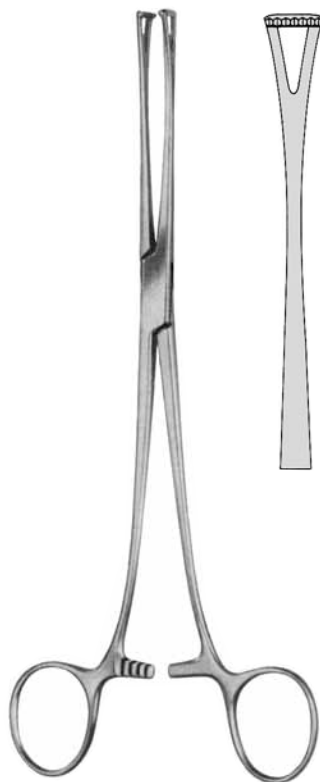

LOCKWOOD
 48.0040 19,5 cm

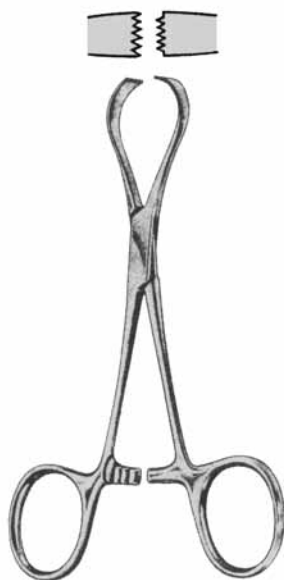

OMBREDANNE
 48.0050 13,5 cm



WILLIAMS
 48.0045 16,5 cm



BABCOCK
 48.0062 16 cm



48.0064
 18 cm

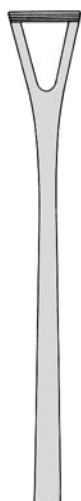

48.0066
 20 cm

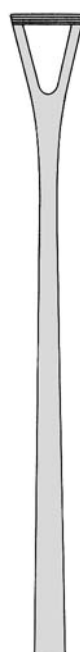

48.0068
 24 cm

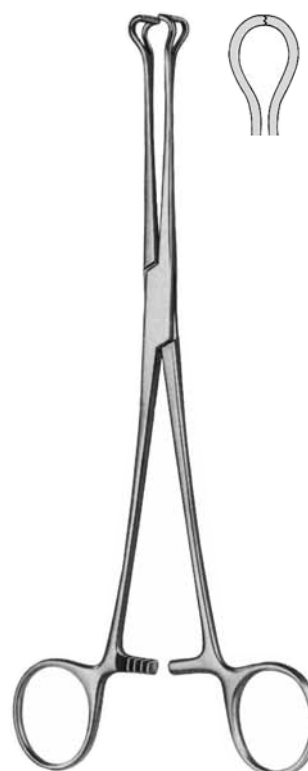

BABCOCK-DEBAKEY
 48.0069 36 cm

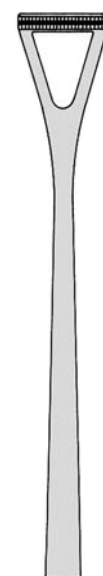



BABCOCK



48.0072
16 cm

48.0074
18 cm



48.0076
20 cm

48.0078
24 cm

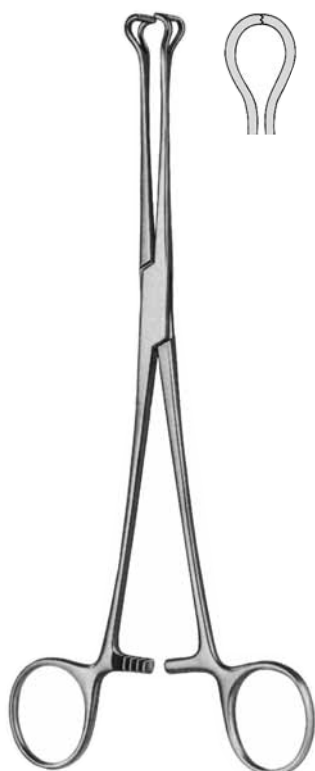

BABCOCK-DEBAKEY



48.0082
16 cm

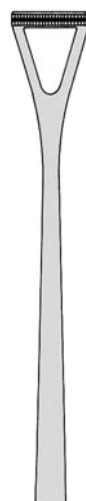

48.0086
20 cm

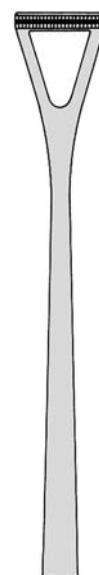

48.0088
23 cm



COLLIN
48.0089
 14 cm



DUVAL



48.0090
 18 cm / 14 mm
48.0092
 20 cm / 14 mm

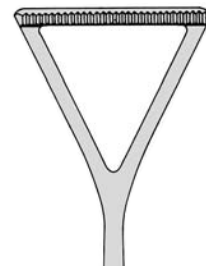

48.0094
 20 cm / 25 mm
48.0098
 23 cm / 25 mm

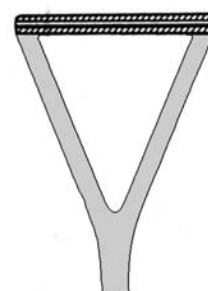

48.0094AT
 20 cm / 20 mm
48.0098AT
 23 cm / 25 mm
 atraumatisch
 atraumatic
 atraumatique
 atraumática
 atraumatiche



DUVAL



48.0099
 20 cm / 15 mm





15.1580
25 cm



15.1582
27 cm



DEBAKEY

atraumatisch
atraumatic
atraumatique
atraumática
atraumatiche

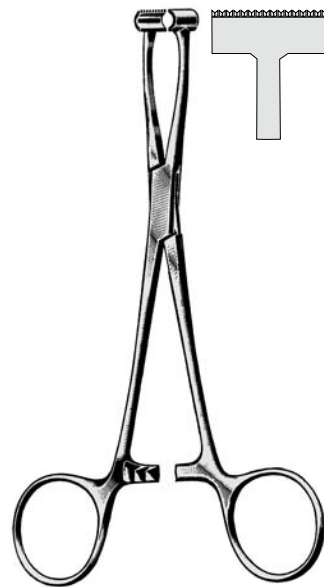

PRATT

15.1350 15 cm



KOCHER-BABY
 13 cm



48.0100



48.0101

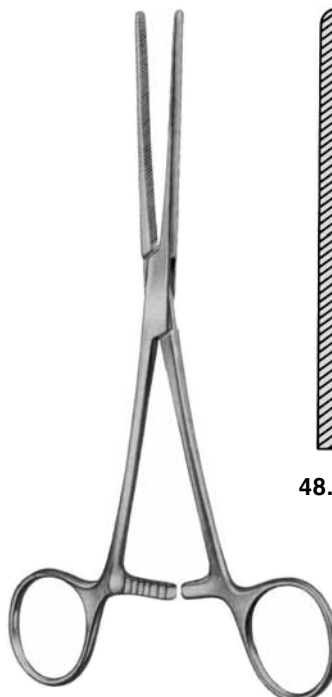

DOYEN
 18 cm



48.0102

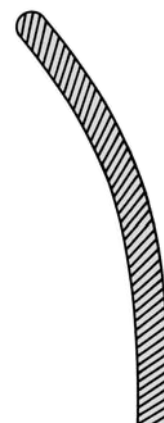

48.0103



DOYEN



48.0104 21 cm

48.0106 23 cm

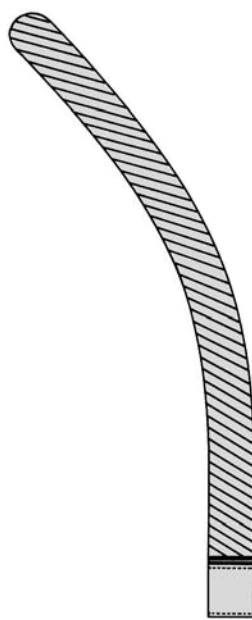

48.0105 21 cm

48.0107 23 cm



LANG-STEVENSON
 48.0210 20 cm

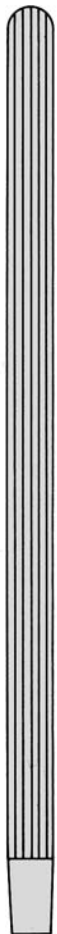

48.0118
25 cm

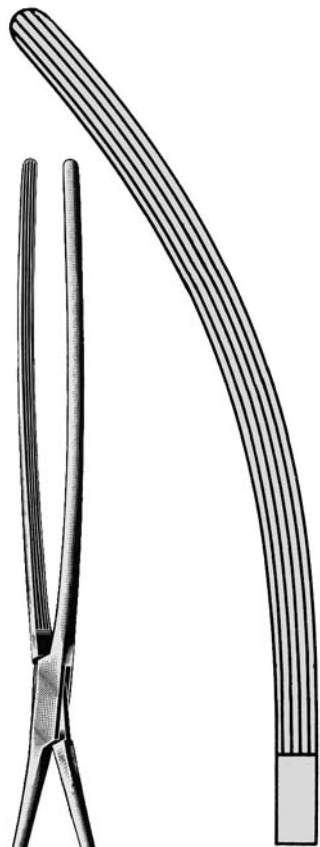

48.0119
25 cm

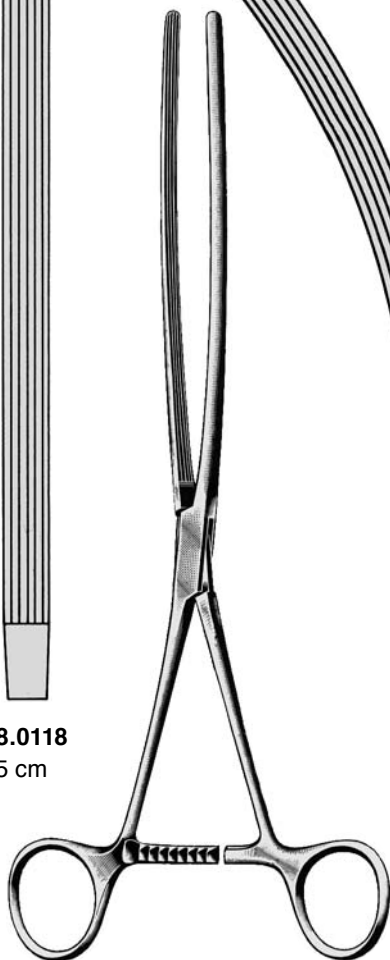

MAYO-ROBSON



48.0120
33 cm

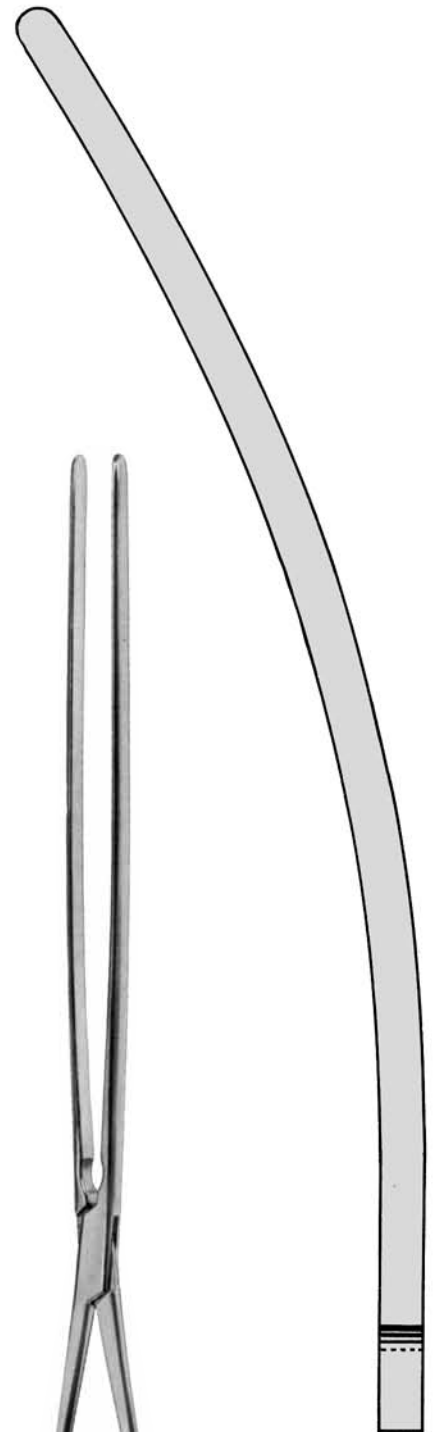

48.0121
33 cm

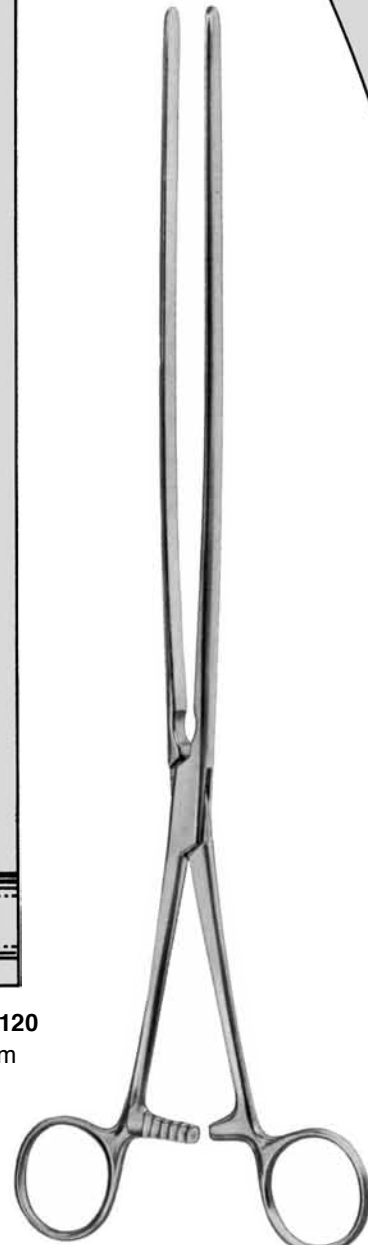

SCUDDER

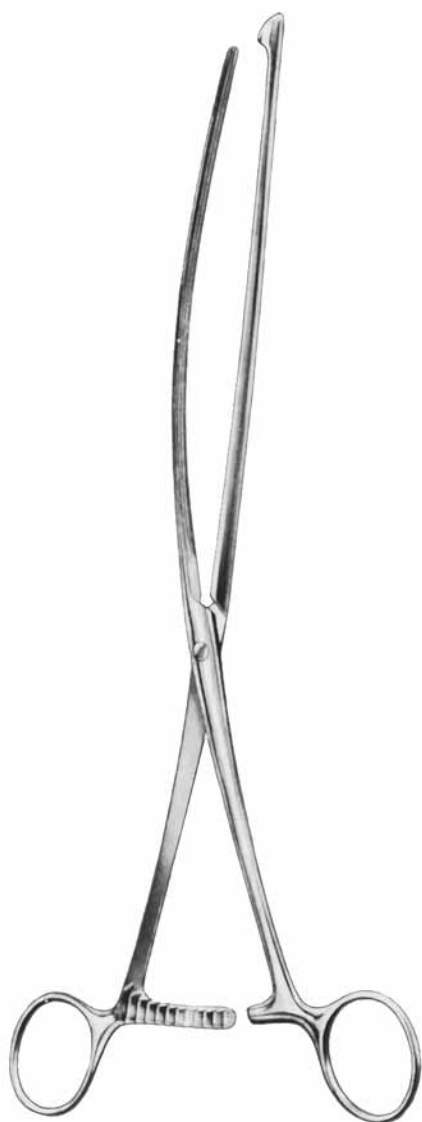

NUSSBAUM
25 cm

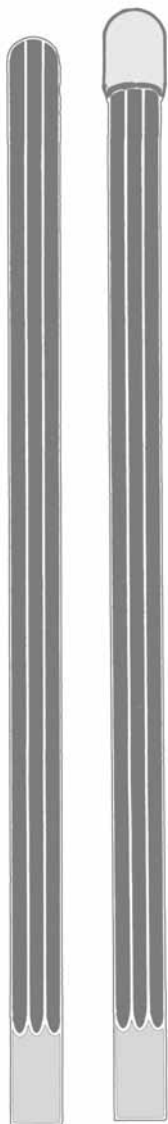

48.0122

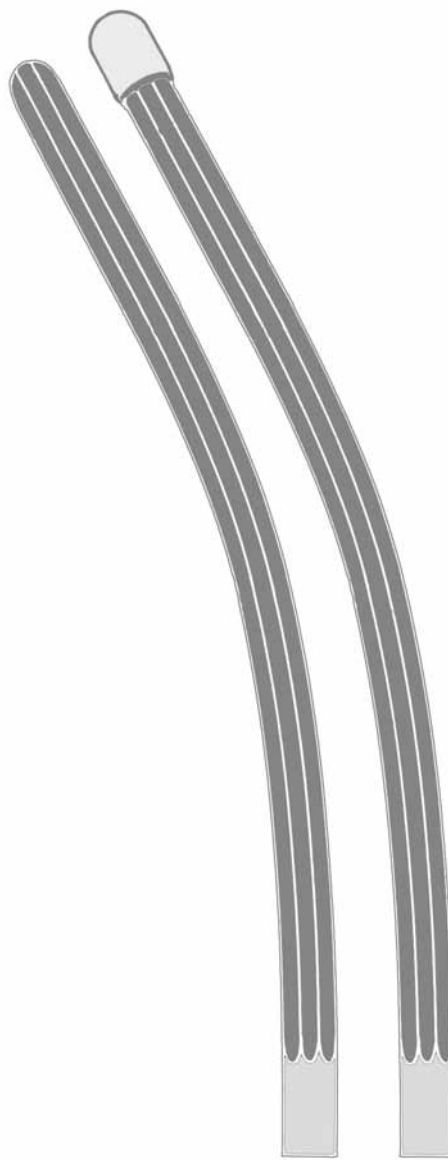

48.0123

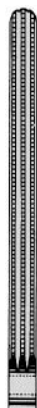

48.0150 13 cm
 48.0152 16 cm

DOYEN-DEBAKEY



48.0151 13 cm
 48.0153 16 cm

DOYEN-DEBAKEY

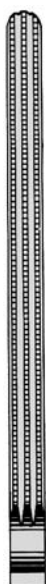

48.0154 18 cm
 48.0156 21 cm
 48.0158 23 cm

DOYEN-DEBAKEY

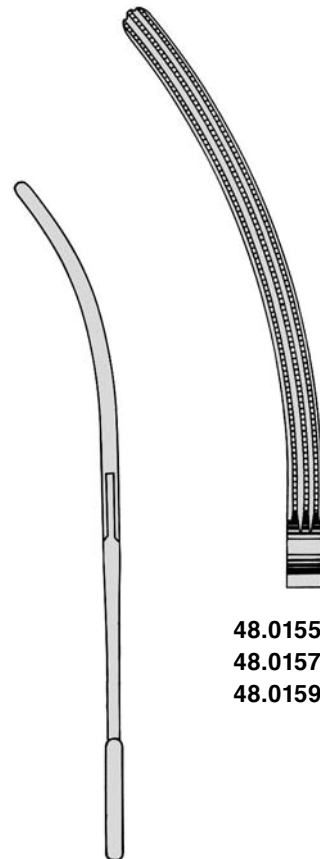

48.0155 18 cm
 48.0157 21 cm
 48.0159 23 cm

DOYEN-DEBAKEY

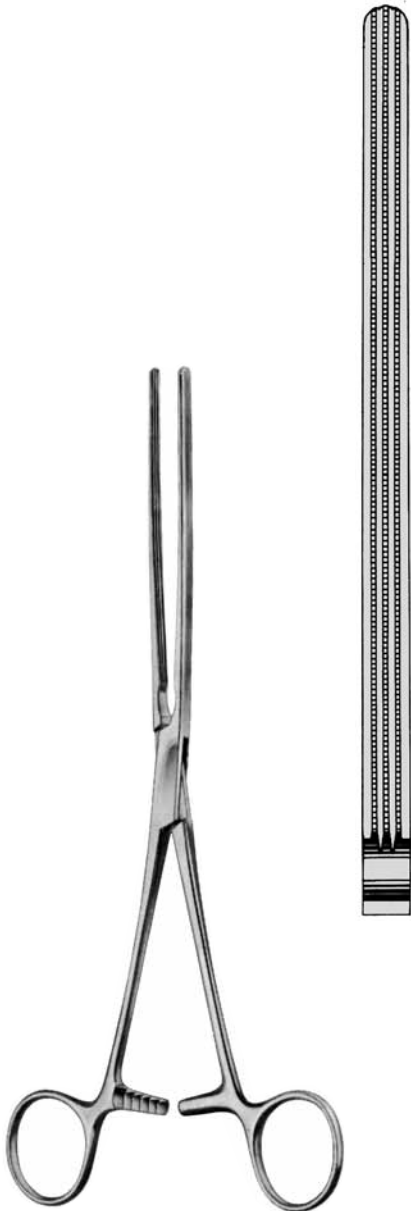

KOCHER-DEBAKEY

48.0160 22 cm

48.0162 25 cm

48.0164 28 cm



KOCHER-DEBAKEY

48.0161 22 cm

48.0163 25 cm

48.0165 28 cm



HAYES-DEBAKEY

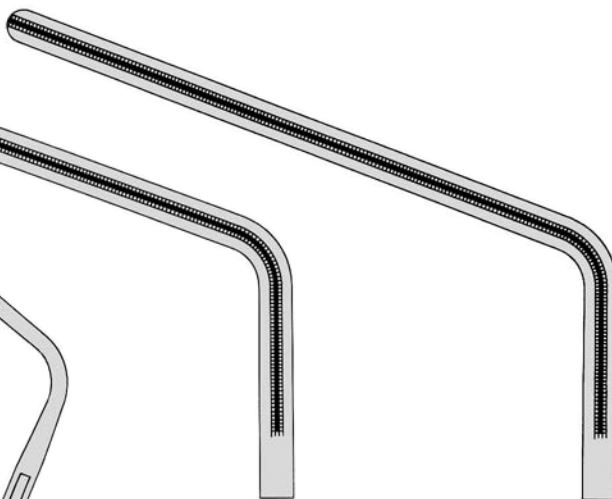

48.0170
26 cm / 55 mm

48.0172
28 cm / 85 mm

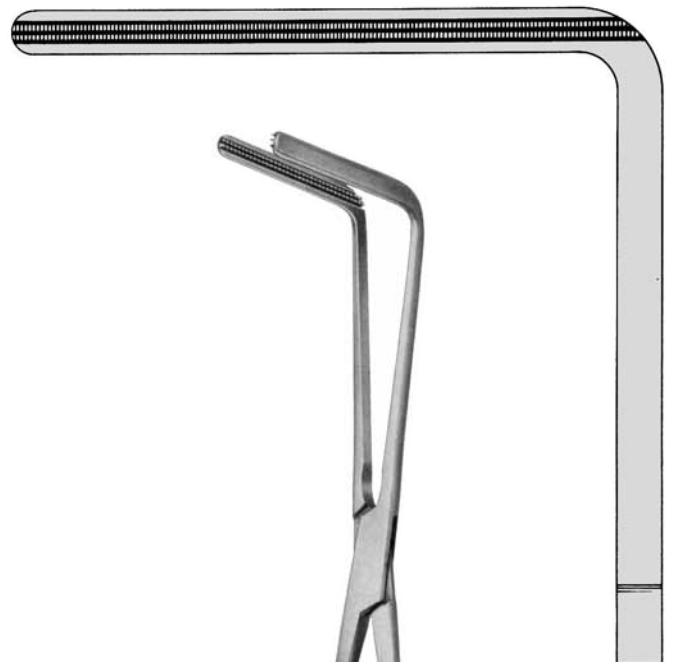

FEHLANT-DEBAKEY
48.0180 24 cm

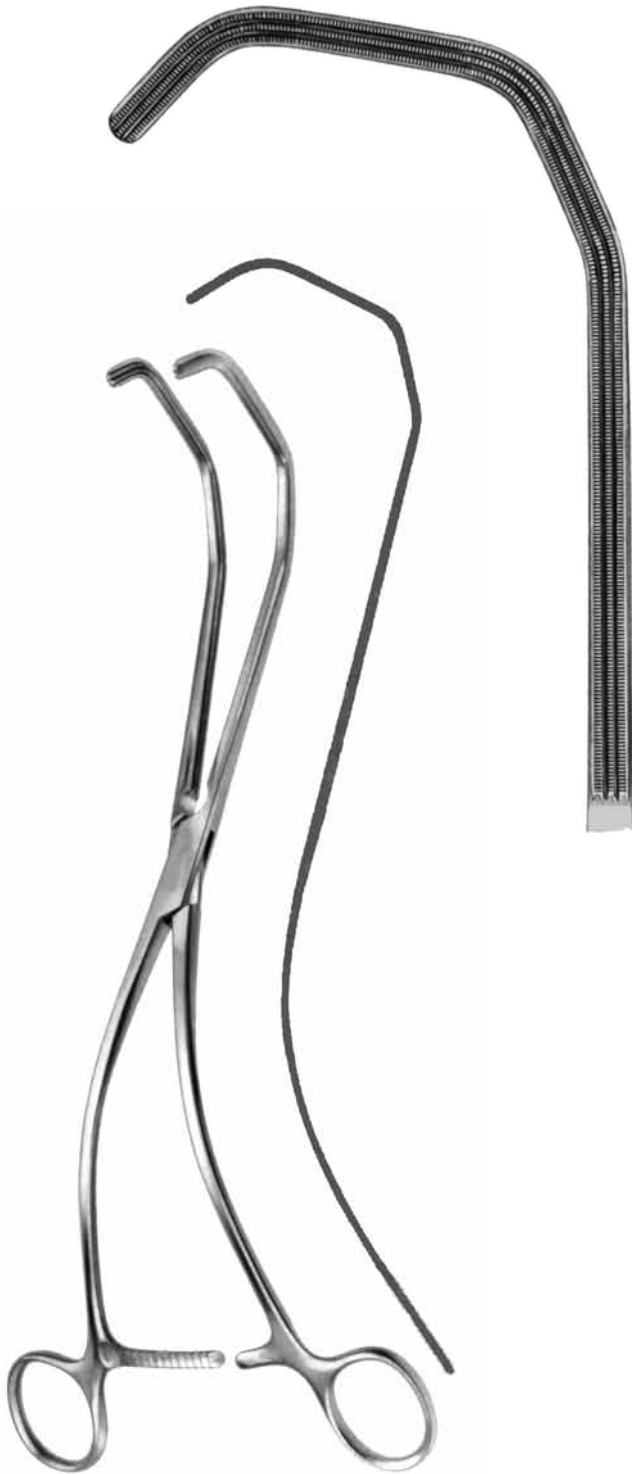

KERSTING
48.0184
31 cm

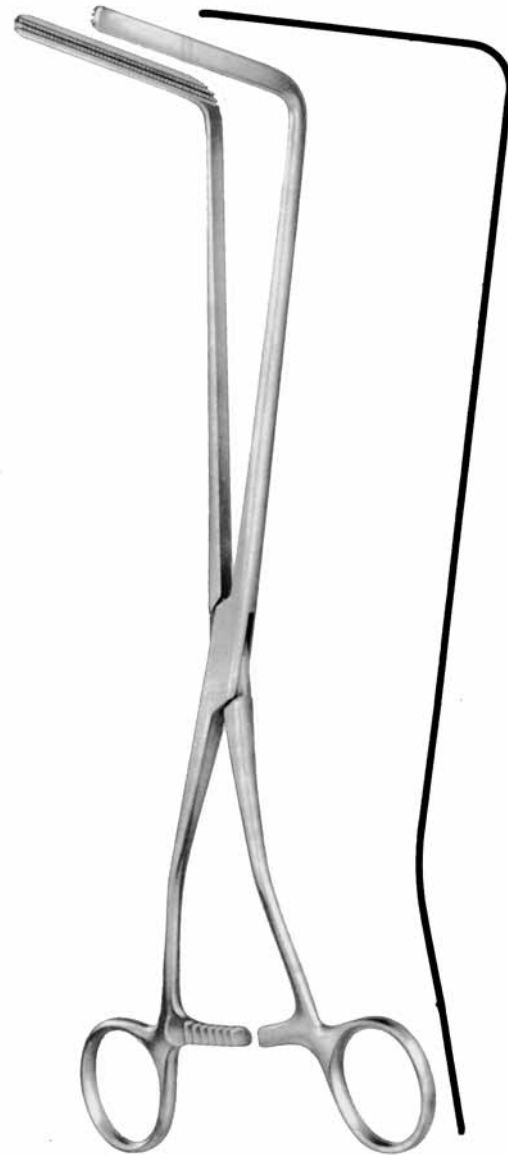

RESANO
48.0186
30 cm



SCUDDER-DEBAKEY
48.0190
33 cm

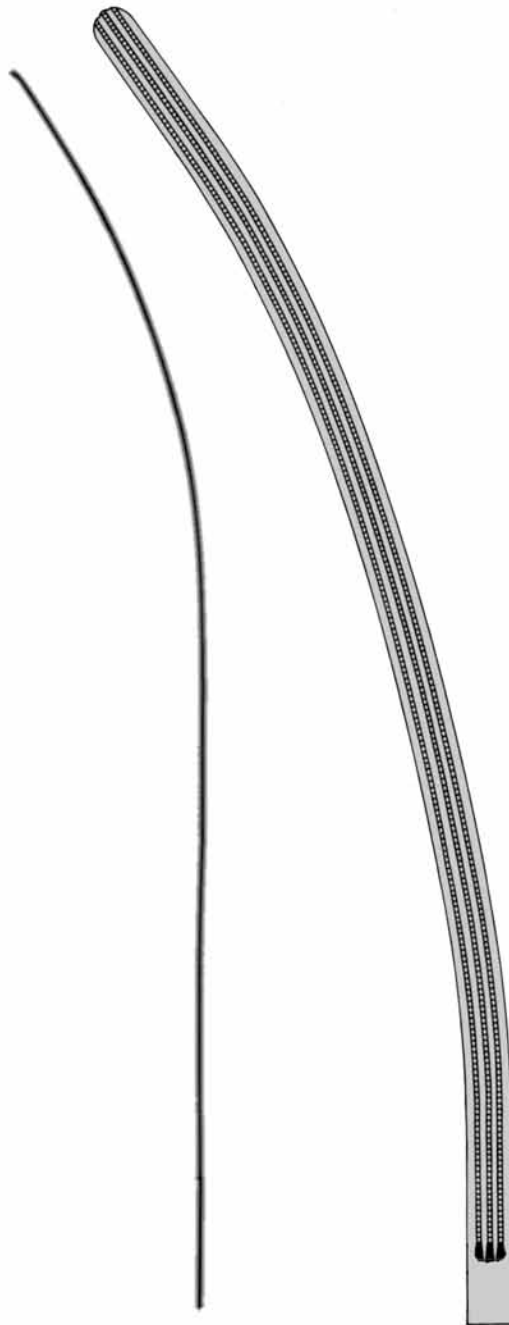

SCUDDER-DEBAKEY
48.0191
33 cm

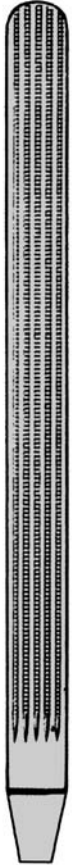

48.0200
25 cm 0°

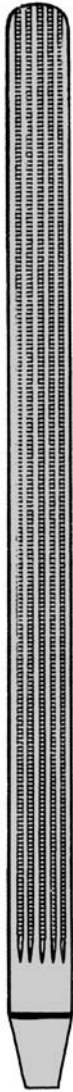

48.0204
28 cm 0°

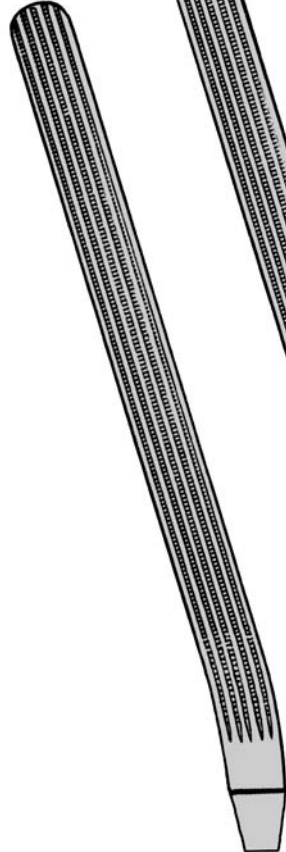

48.0201
25 cm 15°



48.0205
28 cm 15°

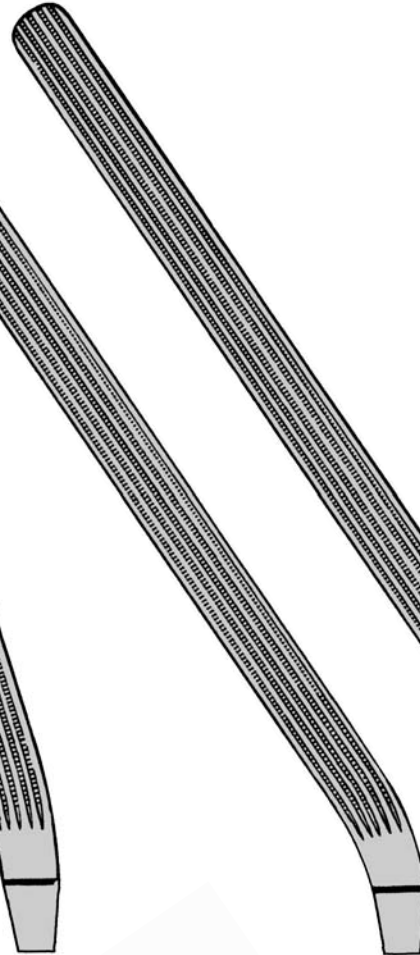

48.0203
25 cm 30°



48.0207
28 cm 30°

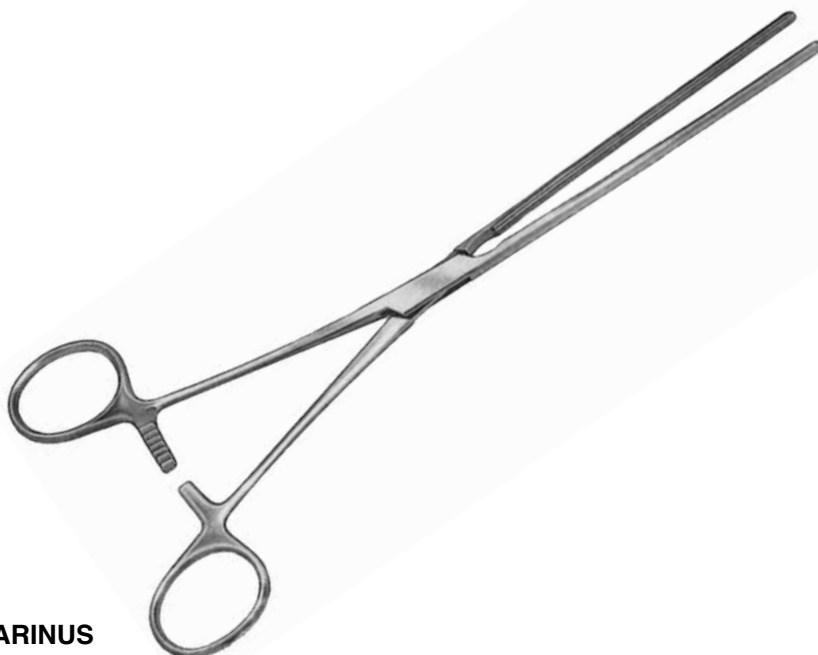

MARINUS

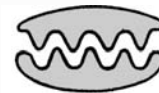



BUIE
 48.0300 21 cm



LLOYD-DAVIES
 48.0350 31,5 cm

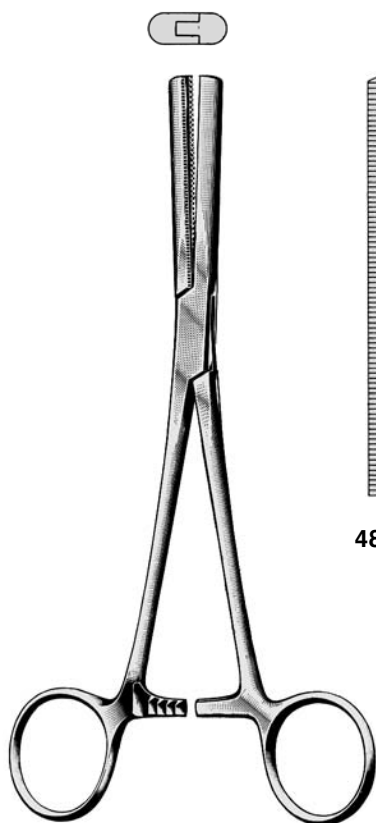

FERGUSSON

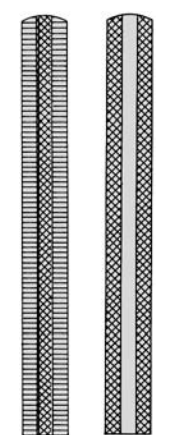

48.0312 20 cm

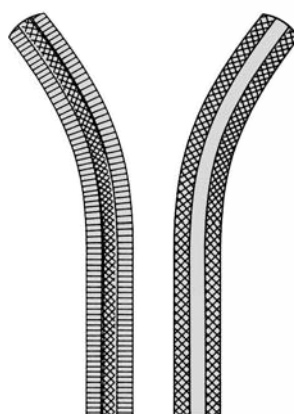

48.0313 20 cm



48.0510 18 cm
mit stift
with pin
avec broche
con espiga
con perno



PAYR-BABY



PAYR



48.0511 20 cm
mit stift
with pin
avec broche
con espiga
con perno

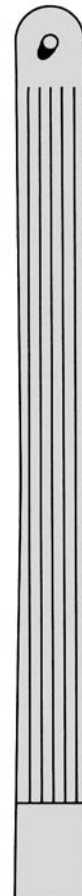

48.0512 28 cm
mit stift
with pin
avec broche
con espiga
con perno

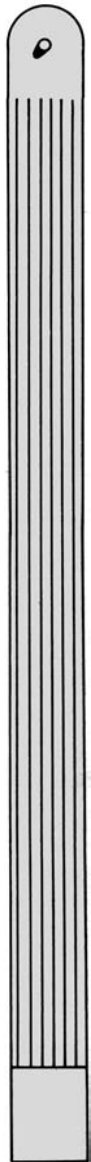

48.0513 35 cm
mit stift
with pin
avec broche
con espiga
con perno



BENSON
48.0700
15 cm

Pylorusspreizer
Pylorus Spreader
Ecarteur du pylore
Separador para piloro
Divaricatore per piloro



KLEINSCHMIDT
48.0710
12,5 cm

Appendektomieklemme
Appendectomy Clamp
Clamp à appendectomie
Pinza para apendectomia
Clamp per appendectomia



48.0530 5 cm



48.0532 7,5 cm



48.0534 10 cm



Satz zu 3 Klemmen
 Set of 3 clamps
 Jeu de 3 clamps
 Juego de 3 clamps
 Set 3 pezzi

DEMARTEL-WOLFSON

Klemmschließzange
 Closing Forceps
 Pince pour fermer les clamps
 Pinza para cerrar los clamps
 Serrapinze

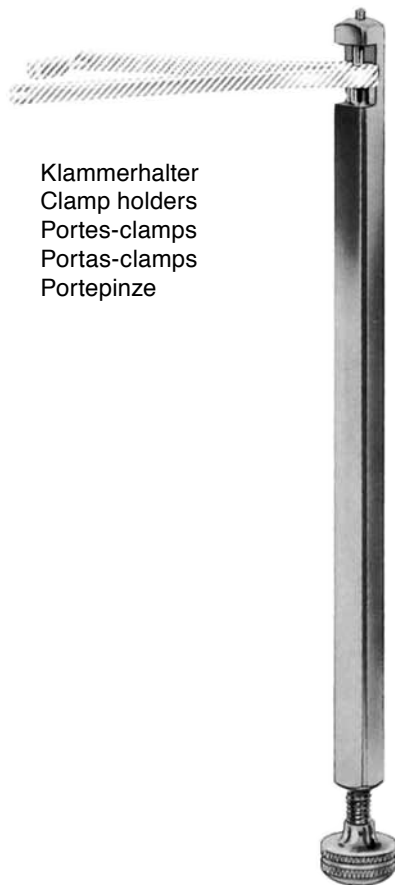

Klammerhalter
 Clamp holders
 Portes-clamps
 Portas-clamps
 Portepinze



**DEMARTEL-
 WOLFSON**
 48.0536 8,5 cm

**DEMARTEL-
 WOLFSON**
 48.0537 23 cm

**DEMARTEL-
 WOLFSON**
 48.0538 26 cm



HILL-FERGUSON
48.0900
21,5cm 60x25mm
48.0902
21,5cm 70x29mm
48.0904
24,0cm 75x40mm



CZERNY
48.1055
22 cm 105x22mm



SIMS
48.1000
16 cm

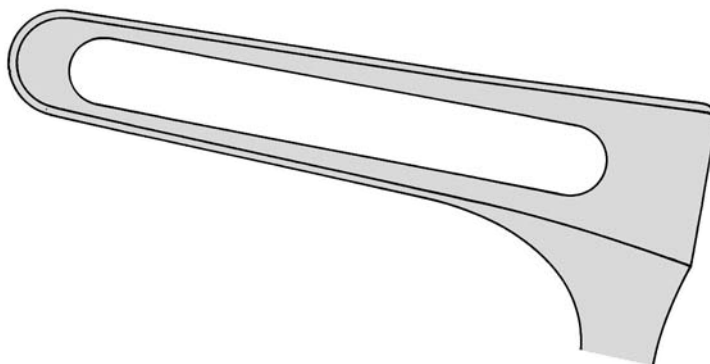

SCHULZE-BERGMANN
22 cm

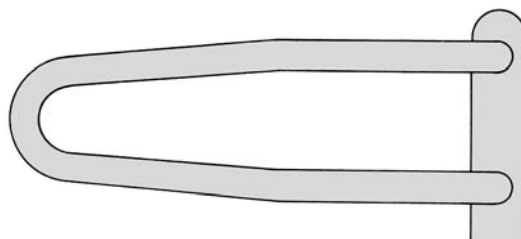

48.1005 65 mm

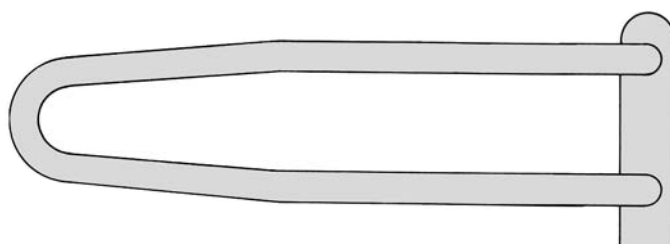

48.1006 85 mm

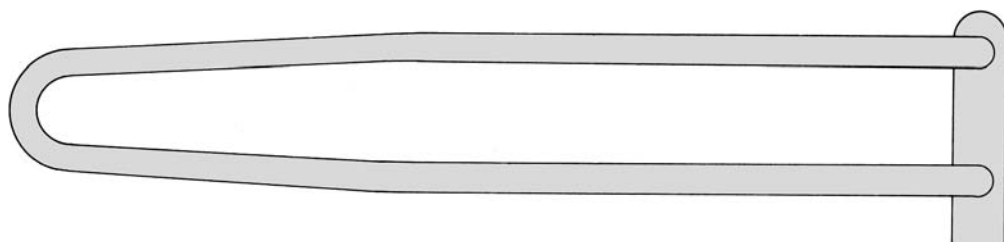

48.1007 125 cm

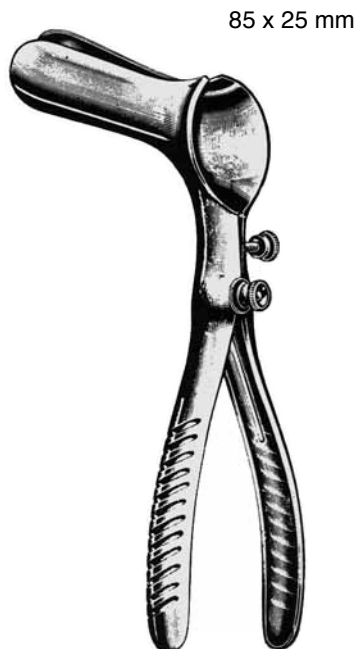

PRATT
48.1020
21,5 cm 85x25mm



MATHIEU
48.1030
19,5 cm 90x15mm



BODENHAMMER
48.1040
15,5 cm

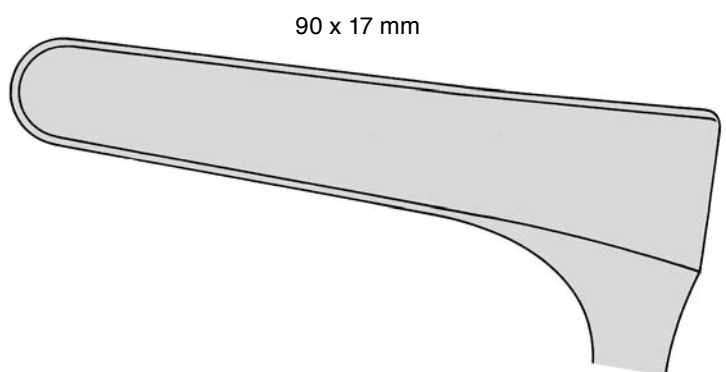

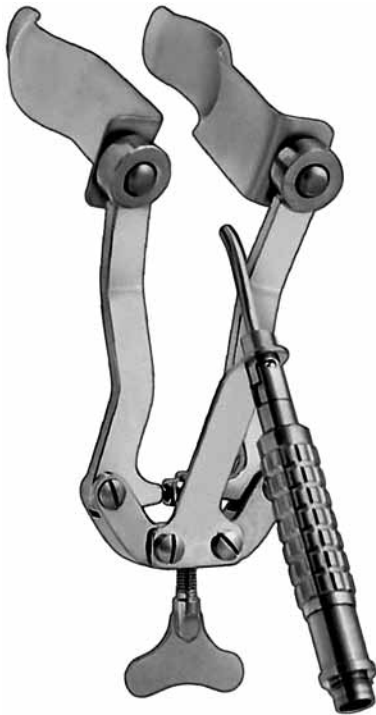

PARKS
49.1046

verwendbar mit Kaltlichtstab 48.1249
useable with Fibre optic handle No. 48.1249
pour embout lumière froide 48.1249
para adaptador luz fria 48.1249
per inserto a fibra ottica 48.1249

bestehend aus: 1 x 48.1047 Rahmen / Frame / Cadre / Bastidor / Telaio
consisting of: 1 x 48.1052 (Paar / Pair / Paire / Par / Paio)
comprendant: 1 x 48.1053 (Paar / Pair / Paire / Par / Paio)
compuesto de:
composta da:



48.1249

Lichtstab für Analspreizer, Proktoskope mit
Adapter für Lichtkabel ACMI, STORZ, WOLF

Fibre Optic Light attachment for Recto-
scopes and -spreaders with connectors for
ACMI, STORZ, WOLF

Embout lumière froide p. Proctoscopes,
Ecarteurs rectaux lumière froide avec
adaptateur ACMI, STORZ, WOLF

Adaptador luz fria para Proctoscopios,
Separadores rectales con adaptador ACMI,
STORZ, WOLF

Inserto per Proctoscopi, Divaricatori rettali
a fibra ottica con adattatore ACMI, STORZ,
WOLF



ALAN-PARKS
48.1052

75x22 mm
Paar / Pair / Paire / Par / Paio



ALAN-PARKS
48.1053

95x24 mm PAAR
Paar / Pair / Paire / Par / Paio

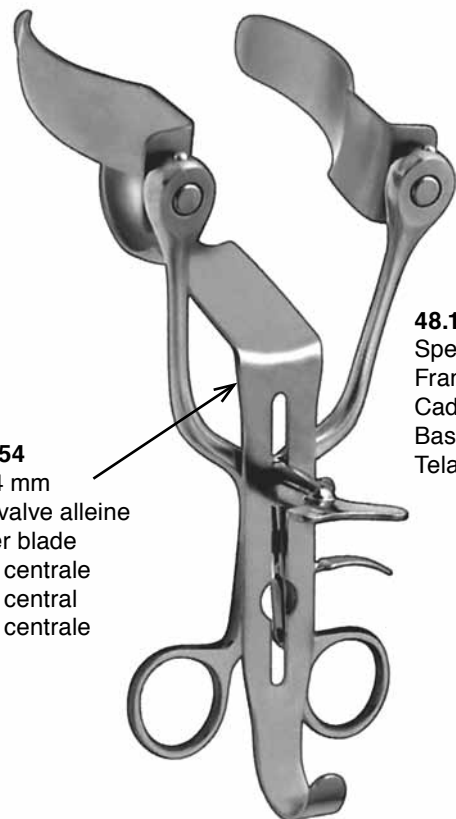

48.1054
95x24 mm
Mittelvalve alleine
Center blade
Valve centrale
Valve central
Valva centrale

48.1051
Sperrer alleine
Frame only
Cadre seul
Bastidor solo
Telaio solo

ALAN-PARKS
48.1050

bestehend aus: 1 x 48.1051 (Sperrer / Frame / Cadre /
Bastidor / Telaio)
consisting of:
comprendant: 1 x 48.1052 (Paar/ Pair/ Paire / Par / Paio)
compuesto de: 1 x 48.1053 (Paar/ Pair/ Paire / Par / Paio)
composta da: 1 x 48.1054 (Mittelvalve / Center blade /
Valve centrale / Valva central / Valva centrale



BARR
48.1070

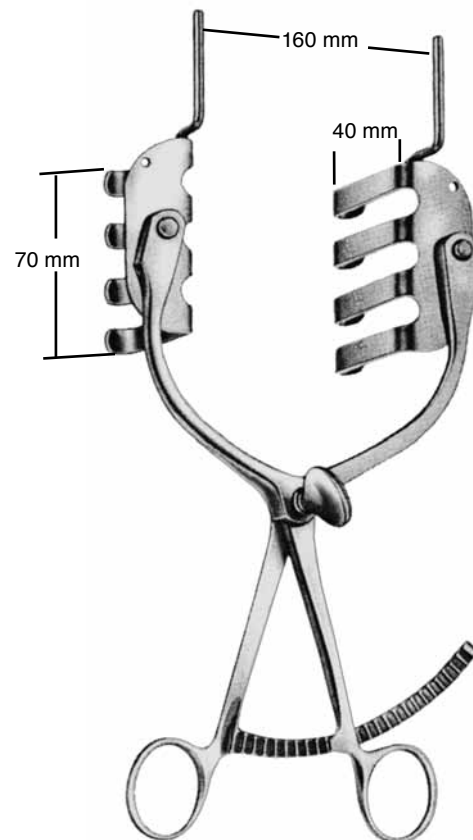

ST.MARKS
48.1080
22 cm
Perinealspreizer
Perineal Retractor
Ecarteur à perinée
Separador para perinea
Divaricatore pelviano



KELLY

48.1200 50 x 21 mm

48.1202 50 x 25 mm

konisch / conical / conique / cónico / conico



KELLY

48.1210 50 x 22 mm

48.1212 100 x 22 mm

48.1214 140 x 22 mm

48.1216 200 x 22 mm



ST.MARKS

48.1220

65X10mm

verwendbar mit Kaltlichtstab 48.1249 (Seite 53)

useable with Fibre optic handle No. 48.1249 (page 53)

pour embout lumière froide 48.1249 (page 53)

para adaptador luz fria 48.1249 (página 53)

per inserto a fibra ottica 48.1249 (pagina 53)



HIRSCHMANN

48.1230 65 x 16 mm

48.1232 65 x 19 mm

48.1234 65 x 22 mm

48.1236 65 x 25 mm



MORGAN

48.1240 65 x 17 mm

48.1242 65 x 20 mm

48.1244 65 x 24 mm

48.1246 80 x 24 mm

verwendbar mit Kaltlichtstab 48.1249

useable with Fibre optic handle No. 48.1249

pour embout lumière froide 48.1249

para adaptador luz fria 48.1249

per inserto a fibra ottica 48.1249



48.1249

Kaltlicht Beleuchtungsstab für Proktoskope, Analspreizer mit ACMI, STORZ, WOLF Anschluß

Fibre Optic Light attachment for Rectoscopes and -spreaders with connectors for ACMI, STORZ, WOLF

Embout lumière froide pour Proctoscopes, Ecarteurs rectaux, lumière froide avec adaptateur ACMI, STORZ, WOLF

Adaptador luz fria para Proctoscopios, Separadores rectales con adaptadores ACMI, STORZ, WOLF

Inserto per Proctoscopi, Divaricatori rettali a fibra ottica con adattatore ACMI, STORZ, WOLF



BENSAUDE

48.1250 70 x 19 mm

48.1252 70 x 22 mm



FANSLER-IVES

48.1255 80 x 22 mm



FANSLER-IVES

48.1256 22 mm

mit Kaltlicht-Anschluss (ACMI,WOLF,STORZ)
with Cold-light attachment (ACMI,WOLF,STORZ)
avec lumière froide (ACMI,WOLF,STORZ)
con alumbrado frio (ACMI,WOLF,STORZ)
con fibra ottica (ACMI,WOLF,STORZ)



55.3600

KALT LICHT-Klammer für Proktoskope & Amnioskope,
Vaginal Spekula mit Kombistecker für alle Systeme

COLDLIGHT-Clip for proctoscopes & amnioscopes
vaginal specula with combi-plug for all systems

CLIP - lumière froide pour proctoscopes, amnioscopes,
spéculum vaginaux avec fiche utilisable pour tous
systèmes

CLIP - luz fria para proctoscopios, amnioskopios,
espéculos vaginales con clavija para todos sistemas

CLIP - illuminazione alogena per proctoscopios, specoli
vaginali e amnioskopios per tutti sistemi



48.1136

Kaltlichtgriff für Anuskope/Proktoskope, WOLF-Anschluß & Kopfstück 48.1140

Fiber optic light handle for anoscopies, proctoscopes with WOLF connector & headpiece 48.1140

Manche à lumière froide pour anoscopies, proctoscopes avec connexion WOLF & tête 48.1140

Mango luz fria para anoscopios, proctoscopios, con conexión WOLF & cabeza 48.1140

Manico a luce fredda per anoscopi, manico a luce fredda per anoscopi, testa 48.1140



48.1137

Adapter für Kaltlichtgriff 48.1136 zum Anschluß an AESCULAP/OLYMPUS/STORZ Kabel

Adapter for fiber optic light handle 48.1136 for connection to AESCULAP/OLYMPUS/STORZ cables

Adaptateur pour manche 48.1136 pour connexion avec câbles AESCULAP / OLYMPUS / STORZ

Adaptore para mango luz fria 48.1136 para conexión con cintas AESCULAP/OLYMPUS/STORZ

Adattore per Manico a luce fredda 48.1136 per connessione con cavi AESCULAP / OLYMPUS / STORZ



48.1140

Kopfstück für Anuskope/Proktoskope 48.1138, 48.1139

Headpiece only for anoscopies, proctoscopes 48.1138, 48.1139

Tête seule pour anoscopies, proctoscopes 48.1138, 48.1139

Cabeza sola para anoscopios, proctoscopios 48.1138, 48.1139

Testa sola per anoscopi, proctoscopi 48.1138, 48.1139

48.1139

Batteriegriff für Anuskope/Proktoskope allein
Battery handle for anoscopies, proctoscopes only
Manche à piles pour anoscopies, proctoscopes seul
Mango de pilas para anoscopios, proctoscopios solo
Manico a batterie per anoscopi, proctoscopi solo

48.1138

Batteriegriff für Anuskope/Proktoskope mit Kopfstück 48.1140 und Glühlampe 2,5V 48.1159

Battery handle for anoscopies, proctoscopes with headpiece 48.1140 & spare lamp 2,5 V 48.1159

Manche à piles pour anoscopies, proctoscopes avec tête 48.1140 et lampe de rechange 48.1159

Mango de pilas para anoscopios, proctoscopios con cabeza 48.1140 y bombilla de repuesto 2,5 V 49.1159

Manico a batterie per anoscopi, proctoscopi con testa 48.1140 e lampadina di ricambio 2,5 V 48.1159



48.1159

Ersatzbirne kurz 2,5 V für Anuskop / Proktoskop-Griff 48.1139

Spare lamp 2,5V for Anoscopes, Proctoscopy handle 48.1139

Lampe de rechange 2,5 V pour Anoscopes, Proctoscopes manche 48.1139

Bombilla de repuesto para anoscopios, proctoscopios 2,5 V para mango 48.1139

Lampadina di ricambio 2,5 V per Anoscopi Proctoscopi manico 48.1139



48.1141

BLOND Proktoskop-Tubus 75mm Ø 18-24 mm konisch mit seitlichem Ausblick, oval
BLOND Proctoscope-tube 75mm Ø 18-24 mm, conical, lateral oval view
BLOND Tube conique de proctoscope 75mm Ø 18-24 mm vue ovale, latérale
BLOND Tubo cónico proctoscopico 75mm Ø 18-24 mm, vista laterale, oval
BLOND Tubo protoscopico, vista laterale ovale, 75mm Ø 18-24 mm



48.1142

BLOND Proktoskop-Tubus 75mm Ø 18-24 mm konisch mit seitlichem Ausblick, rund
BLOND Proctoscope-tube 75mm Ø 18-24 mm conical, lateral round view
BLOND Tube conique de proctoscope 75mm Ø 18-24 mm vue ronde, latérale
BLOND Tubo cónico proctoscopico 75mm Ø 18-24 mm, vista laterale, rondo
BLOND Tubo protoscopico, vista laterale tondo, 75mm Ø 18-24 mm



48.1143

BLOND Proktoskop-Tube 75mm Ø 15-23 mm konisch mit seitlichem Ausblick, oval
BLOND Proctoscope-tube 75mm Ø 15-23 mm conical, lateral oval view
BLOND Tube conique de proctoscope 75mm Ø 15-23 mm vue ovale, latérale
BLOND Tubo cónico proctoscopico 75mm Ø 15-23 mm, vista laterale, oval
BLOND Tubo protoscopico, vista laterale ovale, 75mm Ø 15-23 mm



48.1144

BLOND Proktoskop-Tubus 105mm Ø 18-25 mm konisch m. seitr. Ausblick, oval
BLOND Proctoscope-tube 105mm Ø 18-25 mm conical, lateral oval view
BLOND Tube conique de proctoscope 105mm 18-25 mm vue oval, latérale
BLOND Tubo cónico proctoscopico 105mm 18-25 mm, vista laterale, oval
BLOND Tubo protoscopico, vista laterale ovale, 105mm 18-25 mm



48.1145

BLOND Anoskop mit Mandrin 80mm x Ø 21 mm
BLOND Anoscope with obturator 80 x Ø 21 mm
BLOND Anoscope avec obturateur 80 x Ø 21mm
BLOND Anoscopio con obturador 80 x Ø 21 mm
BLOND Anoscopio con otturatore 80 x Ø 21 mm



48.1146

BLOND Anoskop mit Mandrin 60 x Ø 26 mm
BLOND Anoscope with obturator 60 x Ø 26 mm
BLOND Anoscope avec obturateur 60 x Ø 26 mm
BLOND Anoscopio con obturador 60 x Ø 26 mm
BLOND Anoscopio con otturatore 60 x Ø 26 mm



48.1147

BLOND Anoskop mit Mandrin 80 x Ø 24 mm
BLOND Anoscope with obturator 80 x Ø 24 mm
BLOND Anoscope avec obturateur 80 x Ø 24 mm
BLOND Anoscopio con obturador 80 x Ø 24 mm
BLOND Anoscopio con otturatore 80 x Ø 24 mm



48.1148

BLOND Anoskop mit Mandrin 120 x Ø 21 mm zylindrisch, gerader Ausblick geschlitzt
BLOND Anoscope with obturator 120 x Ø 21 mm cylindrical, straight view, with slot
BLOND Anoscope avec obturateur 120 x Ø 21 mm cylindrique, vue droite, à fente
BLOND Anoscopio con obturador 120 x Ø 21 mm cilíndrico, vista recta, ranurado
BLOND Anoscopio con otturatore 120 x Ø 21 mm cilindrico, vista diritta, spaccato

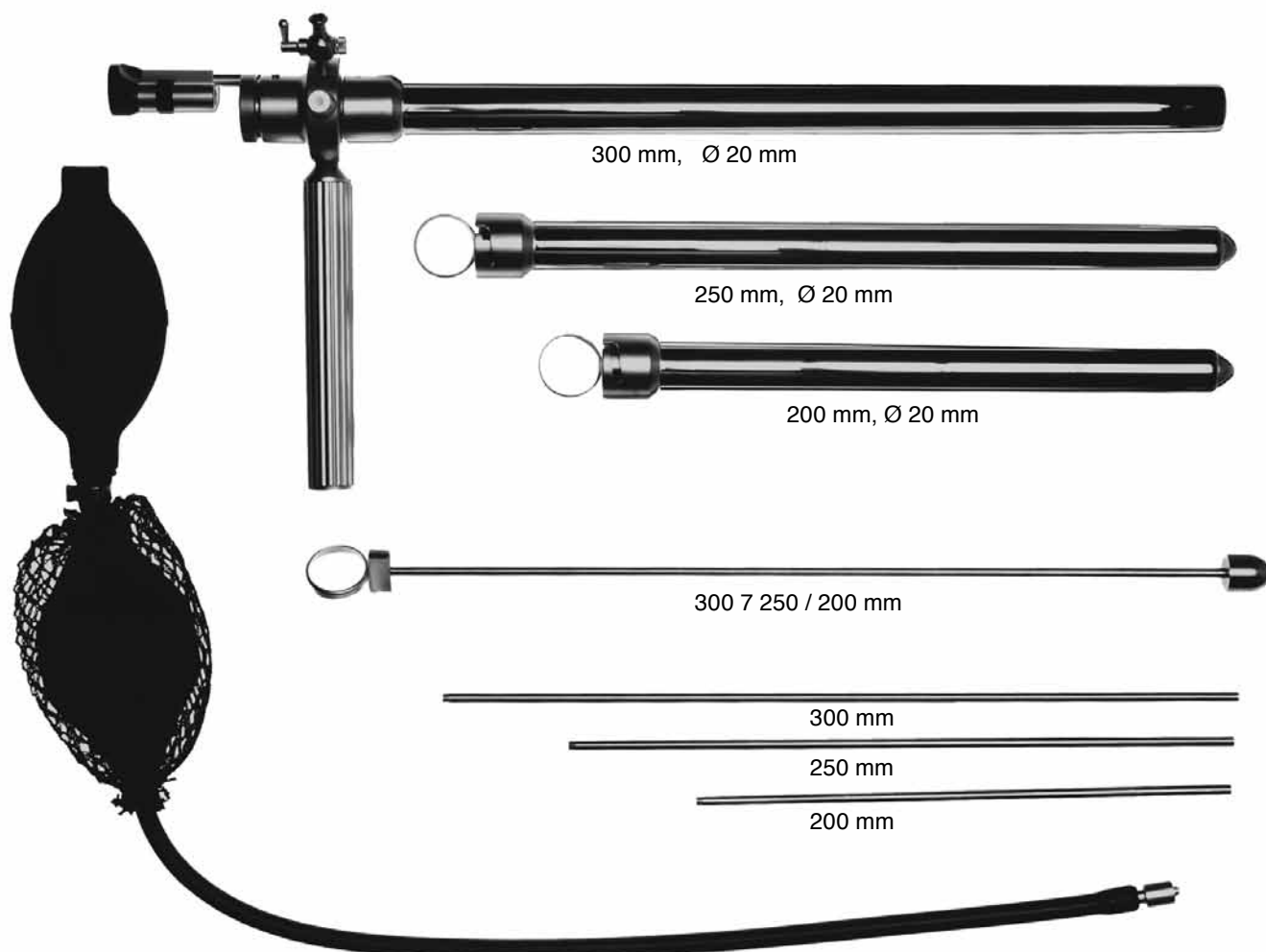

STRAUSS 48.1270

Rektoskop mit Kaltlicht-Beleuchtung komplett
Rectoscope with Fibre Light illumination complete
Rectoscope avec illumination à lumière froide, complet
Rectoscopio, iluminación para luz fría, completo
Rettoscopio con illuminazione luce fredda, completo

10.2000

Kaltlichtquelle Halogen HL 150W, 230 V, B 175 x H 82,5 x T 202mm.
Schutzklasse BF
Halogen Cold Light Projector HL 150, 230V, Size 175 x 82,5 x 202mm,
Protective Class BF
Dispositif à lumière froide Halogène, HL 150W, 230 V, 175 x 82,5 x 202mm;
Classe de protection BF
Proyector halógeno de luz fría HL 150W 230 V, 175 x 82,5 x 202mm,
Clase de protección BF
Proiettore Luce Fredda Alogeno HL 150W 230 V.; 175 x 82,5 202 mm;
classificazione di protezione BF



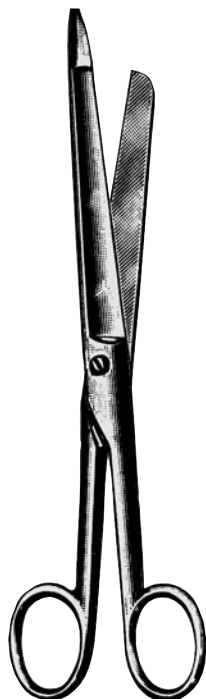

ENTEROTOMY
13.2170 21 cm

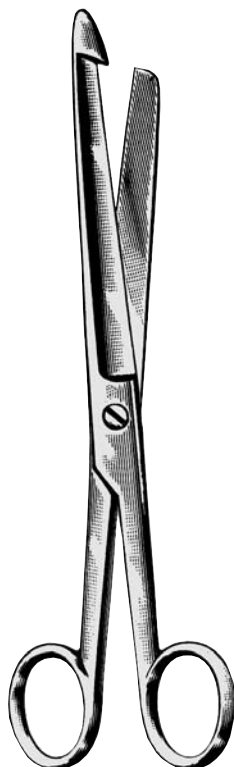

ENTEROTOMY
13.2172 21 cm

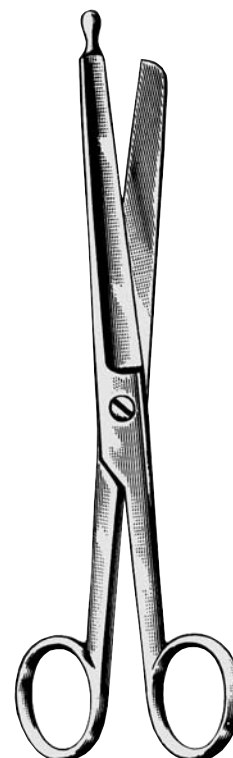

ENTEROTOMY
13.2174 21 cm

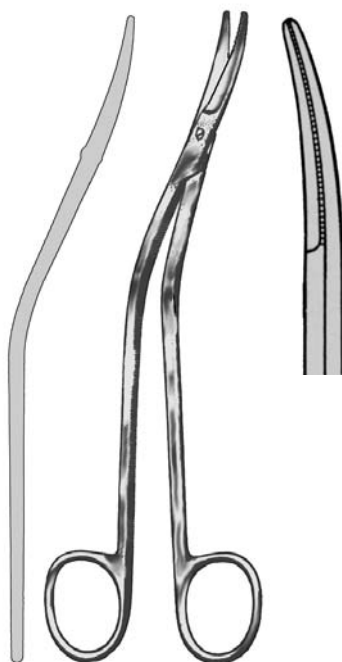

MILLER
13.2181 17 cm

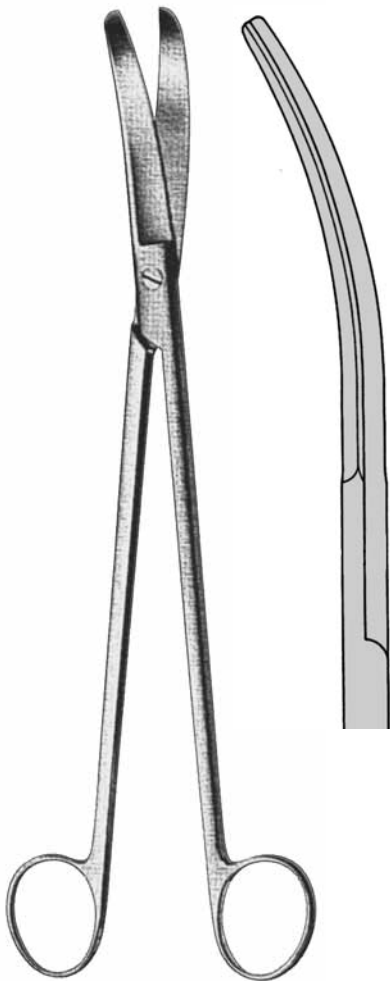

LLOYD-DAVIS
13.2183 27 cm

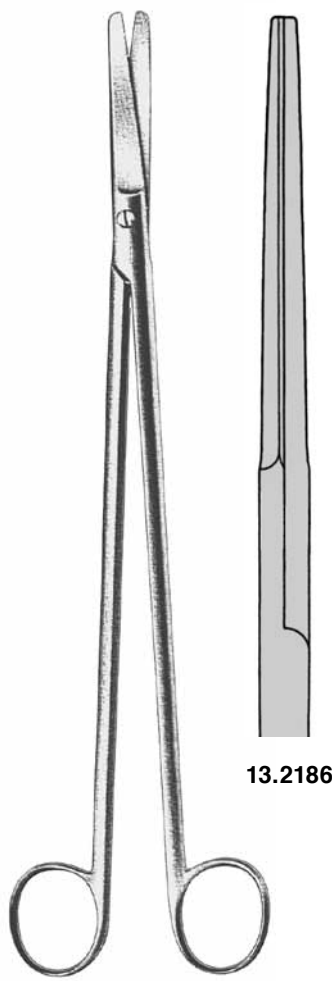

STELZNER
27 cm

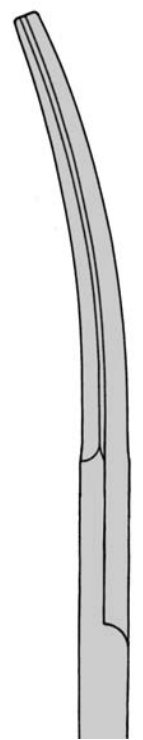

13.2187

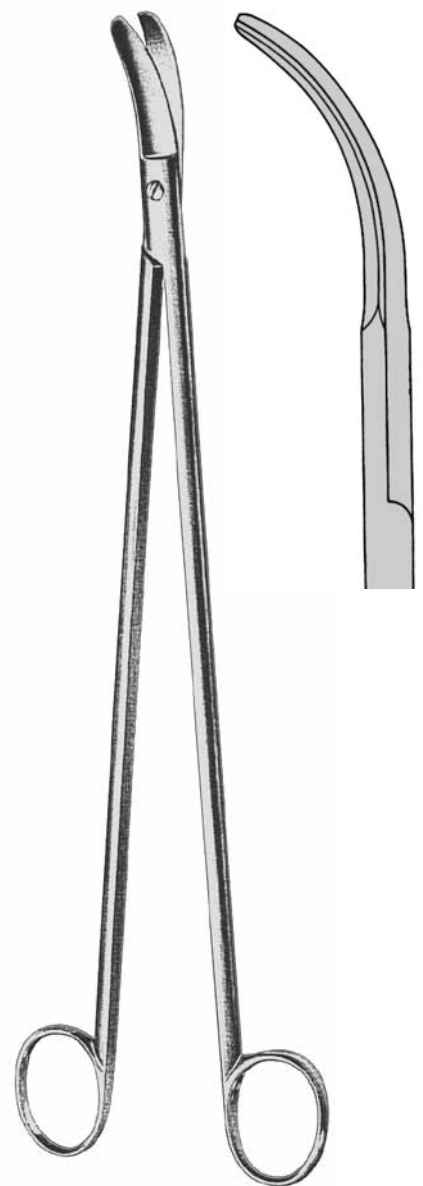

13.2189 32 cm

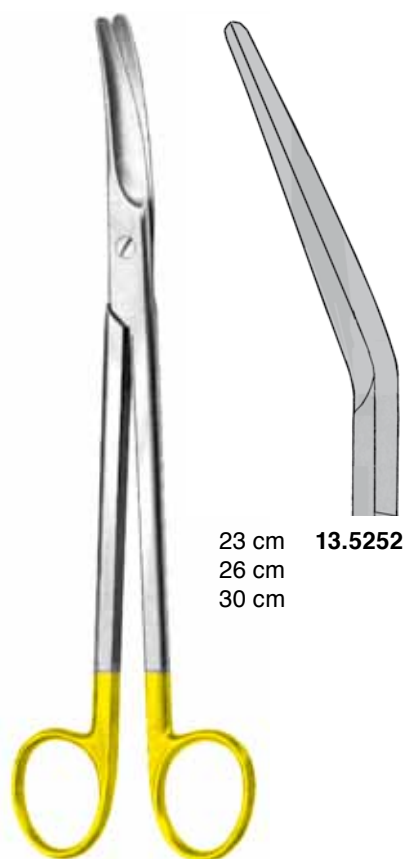

23 cm **13.5252**
26 cm
30 cm

PARAMETRIUM



13.5255
13.5265
13.5275



13.5257
13.5267
13.5277

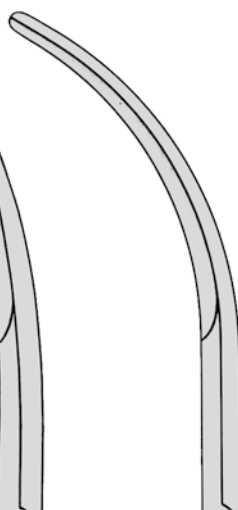

13.5259
13.5269
13.5279



BLESSING
13.5281
30 cm

Schere für Rektumchirurgie
Scissors for rectal surgery
Ciseaux pour chirurgie rectale
Tijera para la cirugía del recto
Forbici per la chirurgia rettale

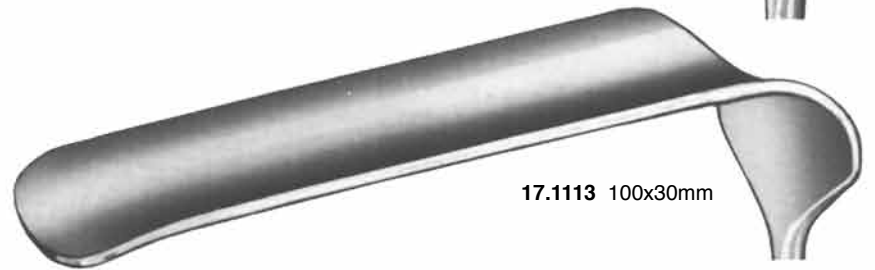

17.1117 220x40mm
ohne Abb. / without illustration / sans illustration / sin ilustración / senza illustrazione

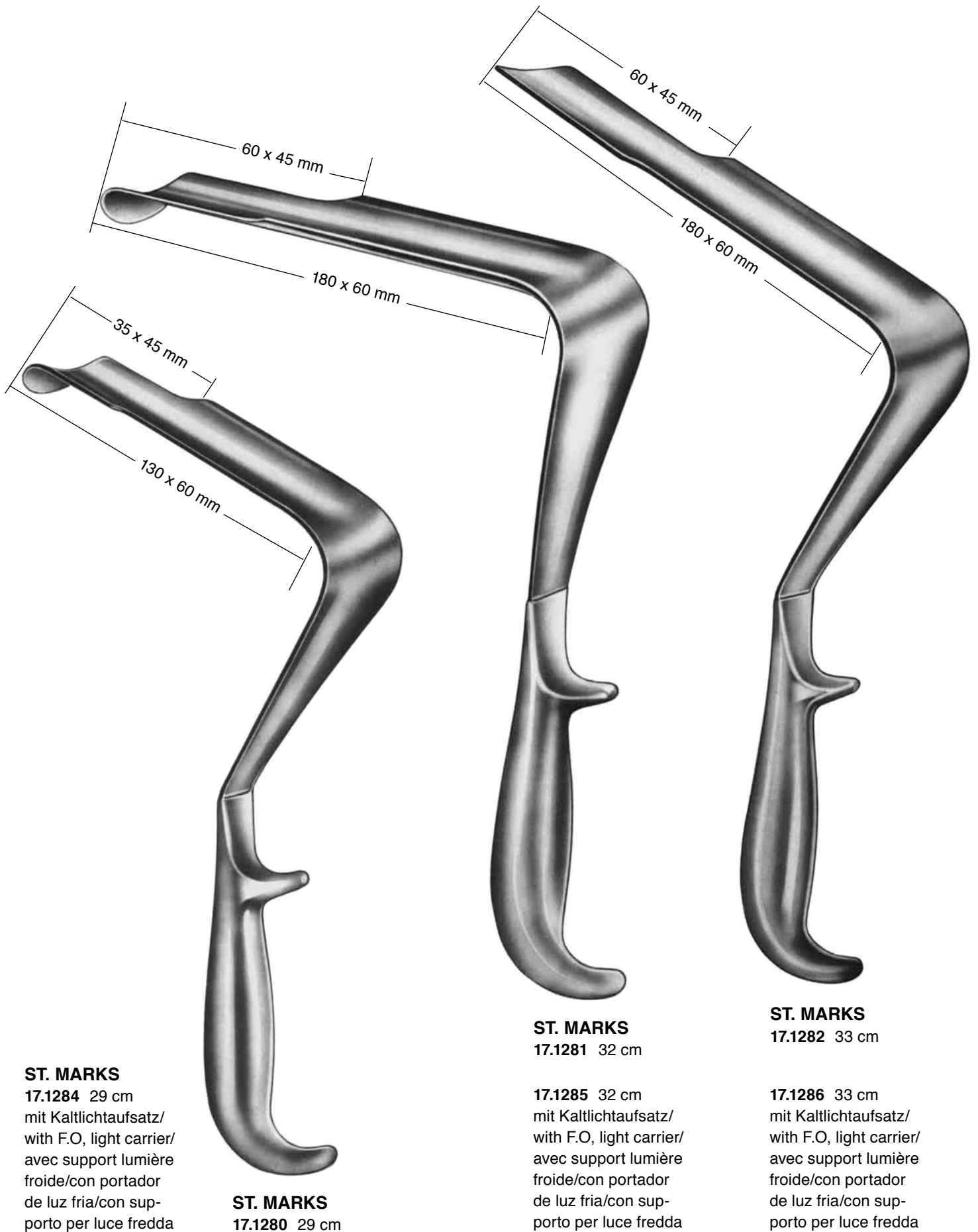

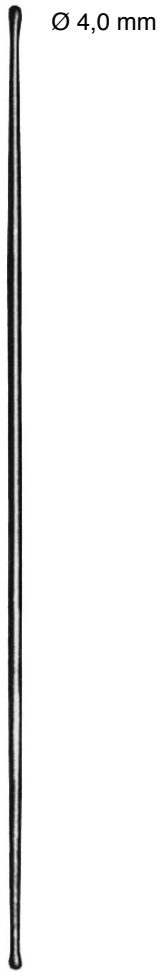

Ø 4,0 mm

19.0128
40 cm

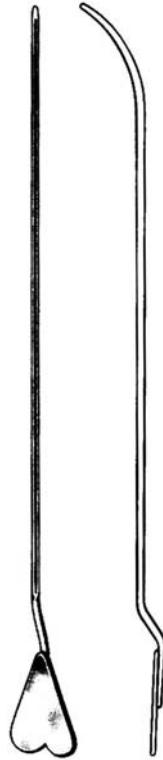

LOCKHART-MUMMERY
16,5 cm



19.0371
1



19.0372
2



19.0373
3



19.0374
4



PRATT
21,5 cm



48.1301
#1



48.1302
#2



48.1303
#3

Cystikus-Häkchen
 Crypt hooks
 Crochets à fistules
 Ganchos para fistulas
 Ganci a cripta



BUIE
48.1310
16 cm

Fistelsonde
 Fistula probe
 Sonde pour fistules
 Sonda para fistulas
 Sonda per fistole



BUIE
48.1420 40 cm

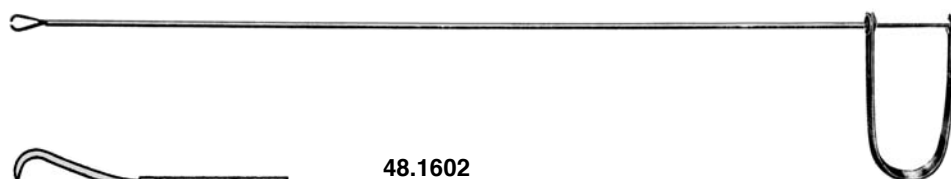

48.1602
38 cm

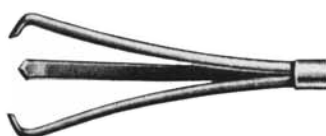

48.1601
28 cm

48.1603
35 cm

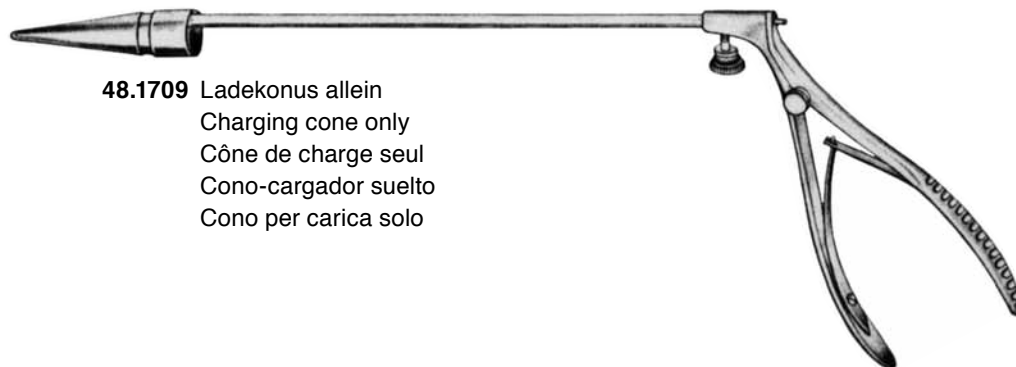

48.1709 Ladekonus allein
Charging cone only
Cône de charge seul
Cono-cargador suelto
Cono per carica solo

MCGIVNEY
48.1700

Haemmoroidal Ligator komplett Ø 12 mm mit Ladeaufsatz 48.1709 und 100 Gummiringen 48.1715

Haemmoroidal Ligator Ø 12 mm complete with loading attachment 48.1709 and 100 rubber rings 48.1715

Ligateur pour hémorroïdes Ø 12 mm avec embout conique 48.1709 et 100 anneaux de caoutchouc 48.1715

Ligador hemorroïdal completo Ø 12 mm con aditamento de carga 48.1709 y 100 anillos de goma 48.1715

Legatore emorroidale Ø 12 mm completo con cono per carica 48.1709 e 100 anelli per legatura de gomma 48.1715

48.1719

Ladekonus für Ø 12 mm Ligator 48.1710
Charging cone Ø 12 mm only for ligator 48.1710
Cône de charge Ø 12 mm pour ligateur 48.1710
Cono-cargador Ø 12 mm para ligador 48.1710
Cono per carica Ø 12 mm solo per ligatore 48.1710



RUDD
48.1710

Haemmoroidal Ligator komplett Ø 12 mm mit Ladeaufsatz 48.1719 und 100 Gummiringen 48.1715

Haemmoroidal Ligator Ø 12 mm complete with loading attachment 48.1719 and 100 rubber rings 48.1715

Ligateur pour hémorroïdes Ø 12 mm avec embout conique 48.1719 et 100 anneaux de caoutchouc 48.1715

Ligador hemorroïdal completo Ø 12 mm con aditamiento de carga 48.1719 y 100 anillos de goma 48.1715

Legatore emorroidale completo Ø 12 mm con cono per carica 48.1719 e 100 anelli per legatura de gomma 48.1715

RUDD
48.1715

Ligatur-Gummiringe, 100 St.
Ligature rubber rings, 100 pcs.
Anneaux en caoutchouc pour ligatures, 100 pièces
Anillos de goma para ligaduras, 100 piezas
Anelli per legatura de gomma, 100 pezzi



48.1709

Ladekonus allein
Charging cone only
Cône de charge seul
Cono-cargador suelto
Cono per carica solo

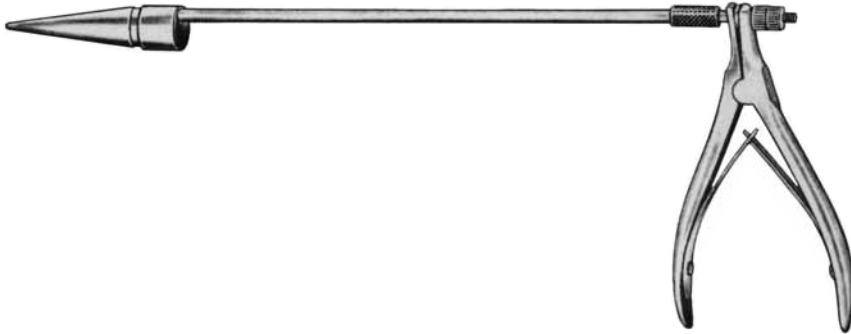

FORD-DIXON
48.1730

Haemorrhoidal Ligator komplett Ø 12 mm mit Ladeaufsatz 48.1709 und 100 Gummiringen 48.1715

Haemorrhoidal Ligator Ø 12 mm complete with loading attachment 48.1709 and 100 rubber rings 48.1715

Ligateur pour hémorroïdes Ø 12 mm avec embout conique 48.1709 et 100 anneaux de caoutchouc 48.1715

Ligador hemorroïdal completo Ø 12 mm con aditamiento de carga 48.1709 y 100 anillos de goma 48.1715

Legatore Ø 12 mm completo con cono per carica 48.1709 e 100 anelli per legatura de gomma 48.1715

48.1748 Ø 8 mm
48.1749 Ø 10 mm

Ladekonus allein
Charging cone only
Cône de charge seul
Cono-cargador suelto
Cono per carica solo

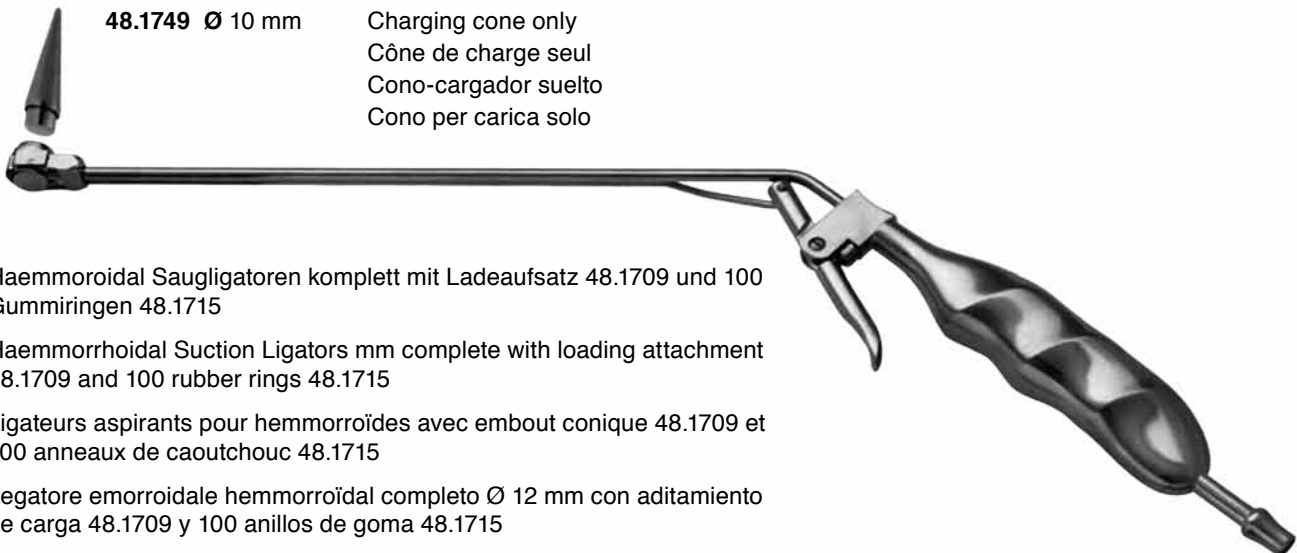

Haemorrhoidal Saugligatoren komplett mit Ladeaufsatz 48.1709 und 100 Gummiringen 48.1715

Haemorrhoidal Suction Ligators mm complete with loading attachment 48.1709 and 100 rubber rings 48.1715

Ligateurs aspirants pour hémorroïdes avec embout conique 48.1709 et 100 anneaux de caoutchouc 48.1715

Legatore emorroidale hemorroïdal completo Ø 12 mm con aditamiento de carga 48.1709 y 100 anillos de goma 48.1715

Legatore completo con cono per carica 48.1749 e 100 anelli per legatura de gomma 48.1715

48.1740 Ø 8 mm
48.1742 Ø 10 mm

90° aufwärts gewinkelt
90° angled up
90° coudé vers le haut
90° acodada hacia arriba
90° angolato in alto

48.1749 Ø 10 mm Ladekonus allein
Charging cone only
Cône de charge seul
Cono-cargador suelto
Cono per carica solo



Hämorrhoidal-Saugligator Ø 10 mm mit Ladeaufsatz und 100 Ligatur-Gummiringen Nr. 48.1715

Haemorrhoidal suction ligator Ø 10 mm with loading attachment and 100 ligature rubber rings No. 48.1715

Ligateur aspirant pour hémorroïdes Ø 10 mm avec embout conique pour dilater les anneaux et 100 anneaux de caoutchouc à ligatures No. 48.1715

Ligador aspirante hemorroidal Ø 10 mm con aditamiento de carga y 100 anillos de goma para ligaduras No. 48.1715

Legatore completo con cono per carica 48.1715 e 100 anelli per legatura de gomma 48.1715

48.1750 Ø 10 mm

30° aufwärts gewinkelt
30° angled up
30° coudé vers le haut
30° acodada hacia arriba
30° angolato in alto

48.1749 Ø 10 mm Ladekonus allein
Charging cone only
Cône de charge seul
Cono-cargador suelto
Cono per carica solo



Hämorrhoidal-Saugligator Ø 10 mm mit Ladeaufsatz und 100 Ligatur-Gummiringen Nr. 48.1715

Haemorrhoidal suction ligator Ø 10 mm with loading attachment and 100 ligature rubber rings No. 48.1715

Ligateur aspirant pour hémorroïdes Ø 10 mm avec embout conique pour dilater les anneaux et 100 anneaux de caoutchouc à ligatures No. 48.1715

Ligador aspirante hemorroidal Ø 10 mm con aditamiento de carga y 100 anillos de goma para ligaduras No. 48.1715

Legatore completo con cono per carica 48.1715 e 100 anelli per legatura de gomma 48.1715

48.1755 Ø 10 mm

30° abwärts gewinkelt
30° angled down
30° coudé ver le bas
30° acodada hacia abajo
30° angolato in basso

48.1749 Ø 10 mm Ladekonus allein
Charging cone only
Cône de charge seul
Cono-cargador suelto
Cono per carica solo



Hämorrhoidal-Saugligator Ø 10 mm mit Ladeaufsatz
und 100 Ligatur-Gummiringen Nr. 48.1715

Haemorrhoidal suction ligator Ø 10 mm with loading
attachment and 100 ligature rubber rings No. 48.1715

Ligateur aspirant pour hémorroïdes Ø 10 mm avec
embout conique pour dilater les anneaux et 100 anneaux
de caoutchouc à ligatures No. 48.1715

Ligador aspirante hemorroidal Ø 10 mm con
aditamiento de carga y 100 anillos de goma para
ligaduras No. 48.1715

Legatore completo con cono per carica 48.1715 e 100
anelli per legatura de gomma 48.1715

48.1756 Ø 10 mm

gerade
straight
droite
recto
retto

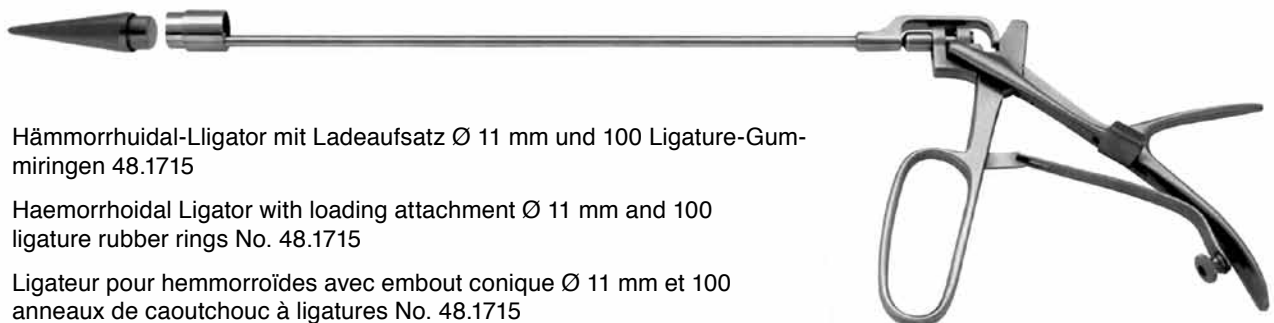

Hämorrhoidal-Lligator mit Ladeaufsatz Ø 11 mm und 100 Ligature-Gum-
miringen 48.1715

Haemorrhoidal Ligator with loading attachment Ø 11 mm and 100
ligature rubber rings No. 48.1715

Ligateur pour hémorroïdes avec embout conique Ø 11 mm et 100
anneaux de caoutchouc à ligatures No. 48.1715

Ligador hemorroidal con aditamiento de carga Ø 11 mm y 100 anillos de
goma para ligaduras No. 48.1715

Legatore completo con cono per carica Ø 11 mm e 100 anelli per
legatura de gomma No. 48.1715

BARRON
48.1760 Ø 11 mm



48.1787
Ø 10 mm x 11 mm

48.1788
Ø 10 mm x 16 mm

Saugkopf allein
Suction head only
Tête aspiratrice seule
Pieza aspiradora sola
Testa aspiratrice sola



48.1789
Ladekonus allein
Loading cone only
Cône de charge seul
Cono de carga solo
Cono per carica solo



48.1781 Ligaturinstrument allein
Ligatur only
Ligateur aspirant seul
Ligador aspirante suelto
Legatore solo

McGIVNEY
48.1780

Haemorrhoidal Saug-Ligator mit je 1 Saugkopf Nr. 48.1787 und 48.1788, Ladekonus Nr. 48.1789 und 100 Ligatur-Gummiringe 48.1715

Haemorrhoidal Suction Ligator with 1 ea. Suction head No. 48.1787 and 48.1788, loading cone No. 48.1789, and 100 ligature rubber rings No. 48.1715

Ligateur aspirant pour hémorroïdes avec une de chaque tête aspiratrice No. 48.1787 et 48.1788, cône de charge No. 48.1789, 100 anneaux de caoutchouc à ligatures No. 48.1715

Ligador aspirante hemorroïdal con cada uno pieza aspiradora No. 48.1787 y 48.1788, cono de carga No. 48.1789, 100 anillos para ligaduras No. 48.1715

Legatore con aspiratore completo con ciascuno testa aspiratrice 48.1787, 48.1788, cono per carica 48.1789, 100 anelli per legatura No. 48.1715



McGIVNEY
48.1702 19 cm



McGIVNEY
48.1704 19 cm

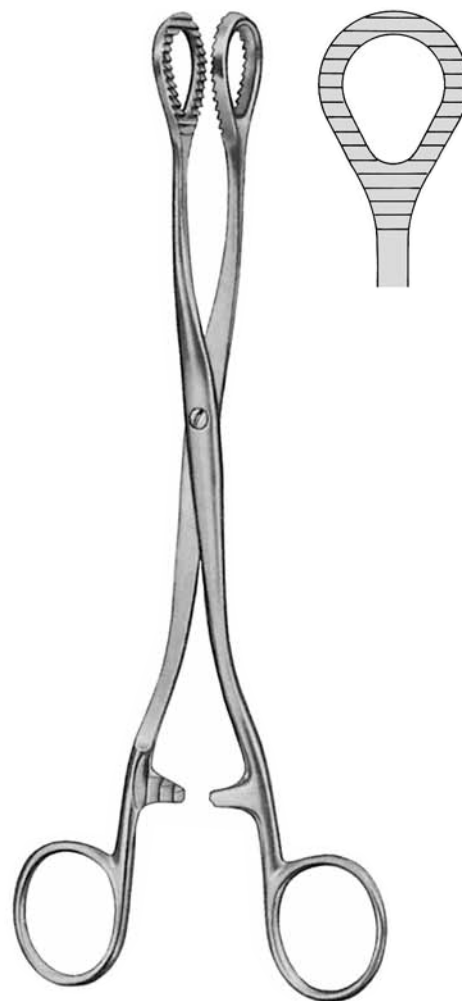

HEYWOOD-SMITH
48.2200 20 cm



BARRON
48.1900 25 cm

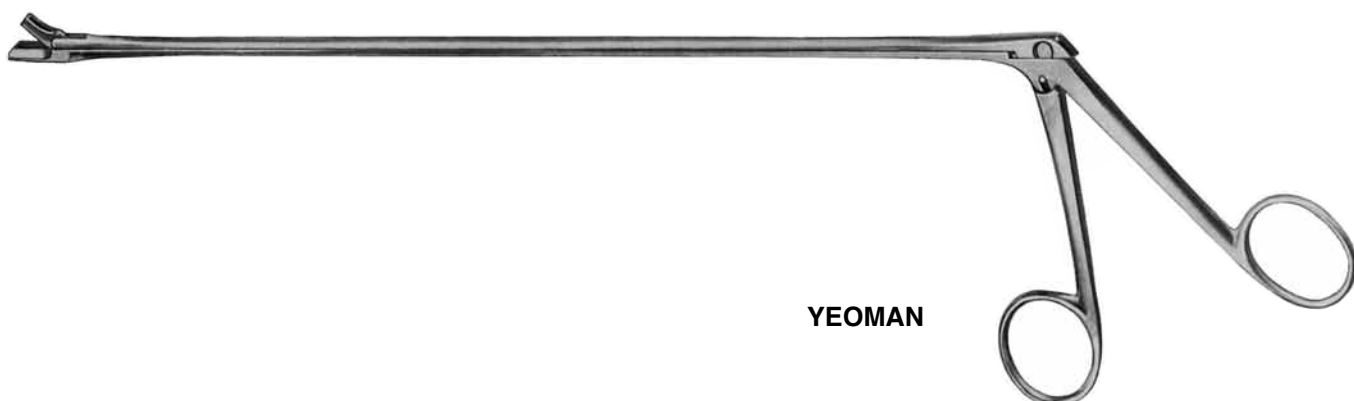

YEOMAN

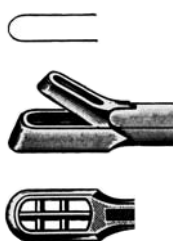

#1

48.2001 28 cm
48.2011 35 cm
48.2015 42 cm

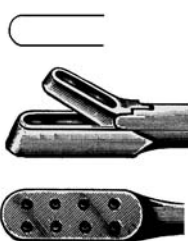

#2

48.2002 28 cm
48.2012 35 cm
48.2016 42 cm

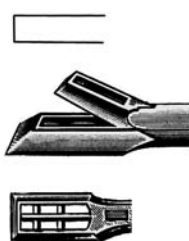

#3

48.2003 28 cm
48.2013 35 cm
48.2017 42 cm

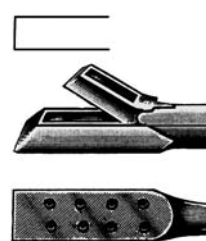

#4

48.2004 28 cm
48.2014 35 cm
48.2018 42 cm

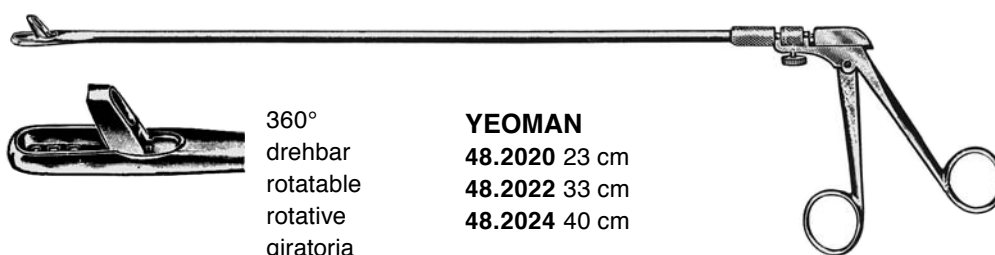

360°
drehbar
rotatable
rotative
giratoria
rotante

YEOMAN

48.2020 23 cm
48.2022 33 cm
48.2024 40 cm

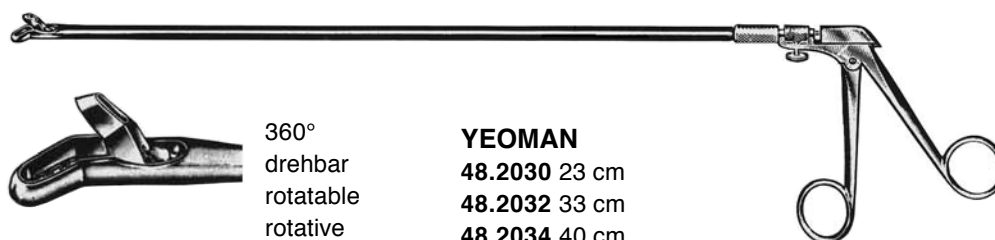

360°
drehbar
rotatable
rotative
giratoria
rotante

YEOMAN

48.2030 23 cm
48.2032 33 cm
48.2034 40 cm

GALLE, LEBER, NIERE

GALL, LIVER, KIDNEY

BILE, FOIE, REIN

BILIS, HIGADO, RINON

BILE, FEGATO, RENE



Empfohlene Operationsbestecke für den Bereich "LEBER, GALLE, NIERE"
(Details erhalten Sie über Ihren Fachhändler)

Suggested Instrument Sets for „LIVER, GALL, KIDNEY“
(Please ask your dealer for details)

Suggestions de boîtes opératoires pour le secteur "BILE, FOIE, REIN".
(Pour plus de détails veuillez contacter votre distributeur.)

Cajas quirurgicas para "BILIS, HIGADO, RINON" (para detalles póngase en
contacto con su distribuidor)

Strumentari raccomandati per "BILE, FEGATO, RENE"
(Per ulteriori informazioni, vi preghiamo di contattare il Vostro rivenditore)

- SET 50.0100** Liver Transplant Set (Donor)
- SET 50.0200** Liver Transplant Set (Recipient)
- SET 50.1000** Kidney Set (Adult)
- SET 50.1100** Kidney Neonatal Set
- SET 50.1200** Kidney Donor Preparation Extras
- SET 50.1350** Kidney Paediatric Transplant Set
- SET 50.1500** Renal Perfusion Set
- SET 50.2000** Cholecystectomy Set
- SET 50.4600** Urethral Dilatation Set

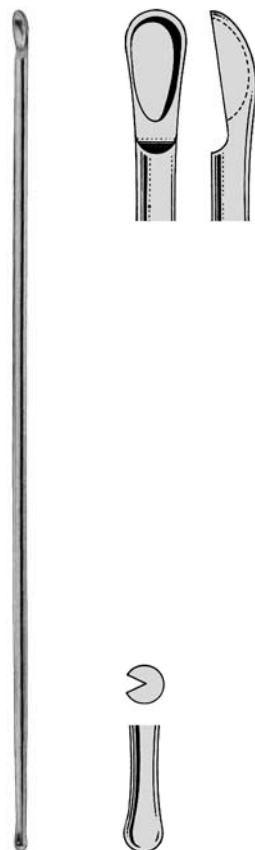

MOYNIHAN
50.0140
34 cm
biegsam
malleable
malléable
maleable
malleabile

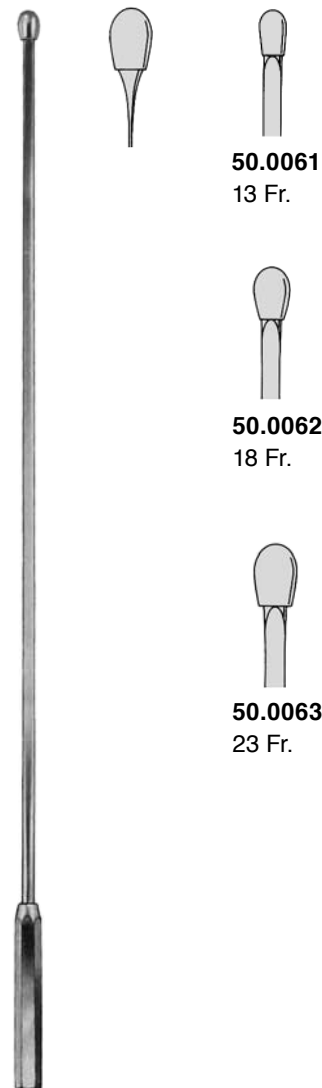

DESJARDINS
30 cm
federnd
elastic
élastique
elásticos
elastico

50.0061
13 Fr.

50.0062
18 Fr.

50.0063
23 Fr.

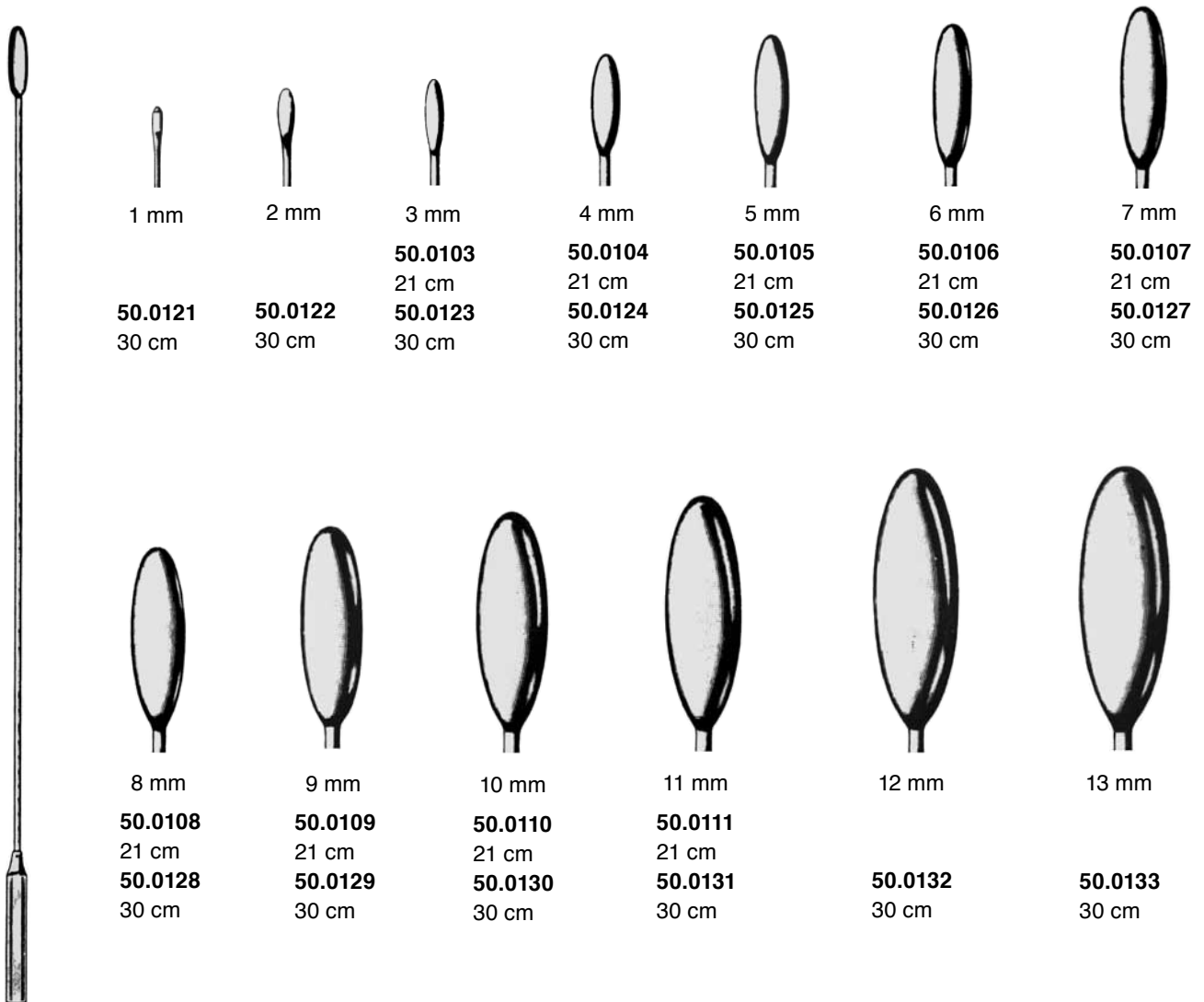

1 mm

2 mm

3 mm

4 mm

5 mm

6 mm

7 mm

50.0103

50.0104

50.0105

50.0106

50.0107

50.0122

50.0123

50.0124

50.0125

50.0126

50.0127

50.0121
30 cm

30 cm

30 cm

30 cm

30 cm

30 cm

30 cm

8 mm

9 mm

10 mm

11 mm

12 mm

13 mm

50.0108

50.0109

50.0110

50.0111

50.0132

50.0133

21 cm

21 cm

21 cm

21 cm

30 cm

30 cm

50.0128

50.0129

50.0130

50.0131

30 cm

30 cm

30 cm

30 cm

30 cm

30 cm

BAKES

Schaft biegsam
 malleable shaft
 tige malléable
 vástago maleable
 gambo flessibile

50.0100

Satz / set / jeu / juego / set
 21 cm 3 - 11 mm

50.0120

Satz / set / jeu / juego / set
 30 cm 1 - 13 mm



MAYO
50.0200
28 cm d/e



MAYO
27 cm

biegsam
malleable
malléable
maleable
malleabile



50.0204
4 mm



50.0205
5 mm



50.0206
7 mm



MAYO
50.0210
27 cm

biegsam
malleable
malléable
maleable
malleabile



MOORE
50.0240
28 cm

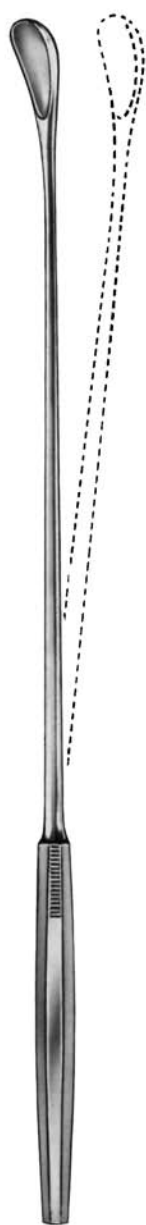

50.0270
2,5 mm



50.0271
3,2 mm



50.0272
4,2 mm



50.0273
5,5 mm



50.0274
6,7 mm



50.0275
8,0 mm



50.0276
11,0 mm



50.0277
15,0 mm



LUER-KOERTE

32 cm

Gallenblasenlöffel, biegsam

Gall Bladder Scoops, malleable

Curettes pour calculs biliaires, malléables

Cucharillas para los cálculos biliares, maleable

Cucchiai per calcoli biliari, maleabili

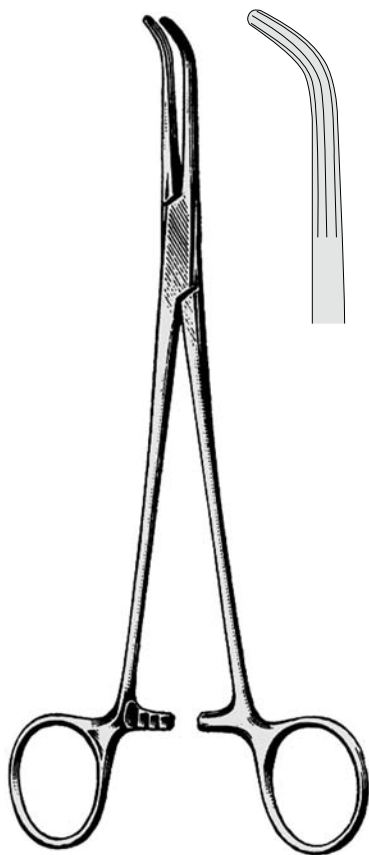

LAHEY
15.0841 19 cm
15.0843 23 cm



MOYNIHAN
15.0901 23 cm
15.0903 24 cm

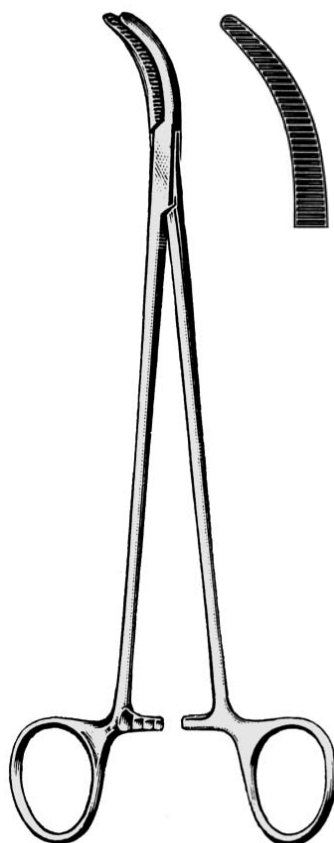

DESJARDIN
15.0911 21 cm

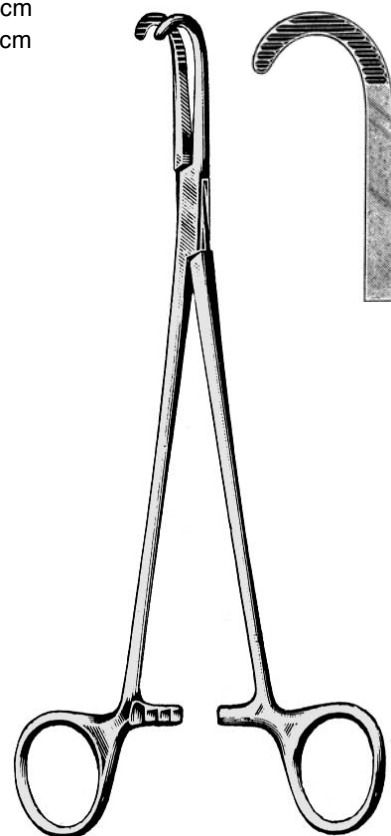

DESJARDIN
15.0913 21 cm

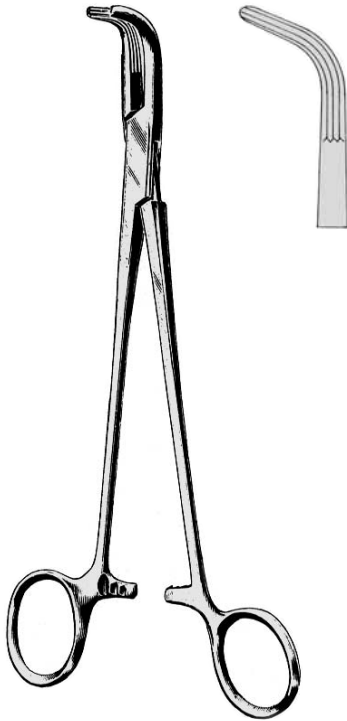

LOWER
15.0931 18 cm



JOHNS-HOPKINS
15.0941 20 cm



MIXTER
15.1015 22 cm

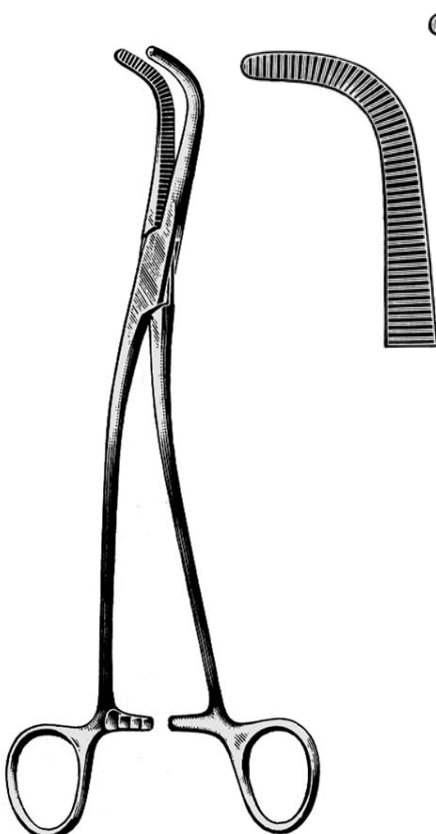

GRAY
15.1031 22 cm #1

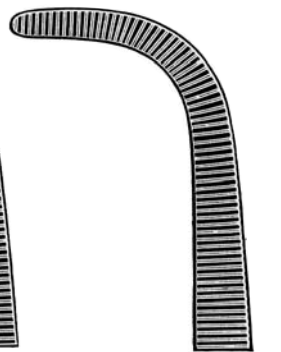

15.1033
23 cm #2

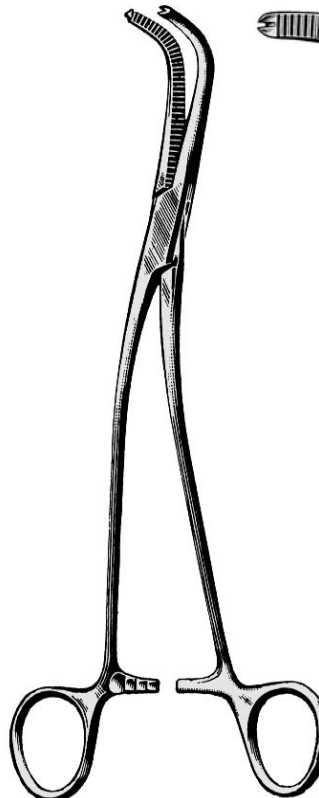

GRAY
15.1035 22 cm #1

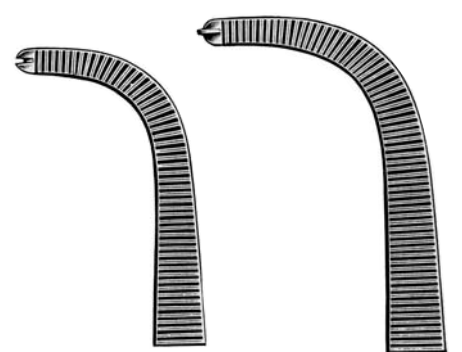

15.1037
23 cm #2



BLAKE
20 cm



50.0300

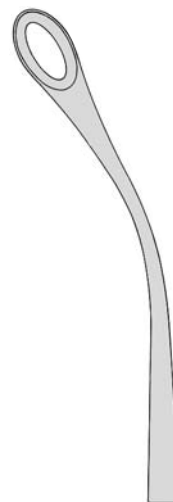

50.0301



DESJARDINS
23 cm



50.0311
#1



50.0313
#2

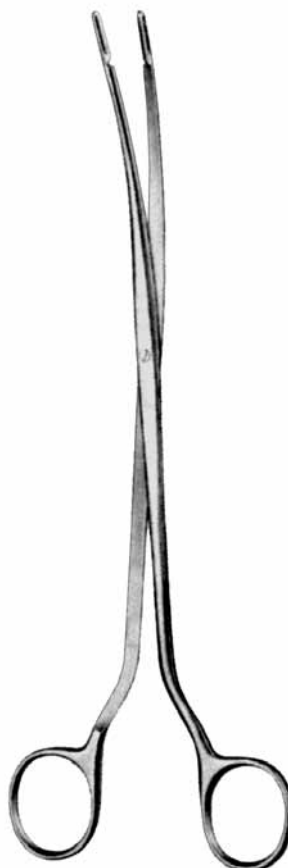

DESJARDINS

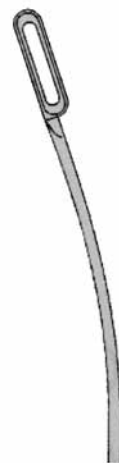

50.0315
24 cm



50.0317
22,5 cm



MAYO-BLAKE
50.0320
20 cm



MAYO-BLAKE
50.0321
20 cm



MIXTER
50.0325
22 cm

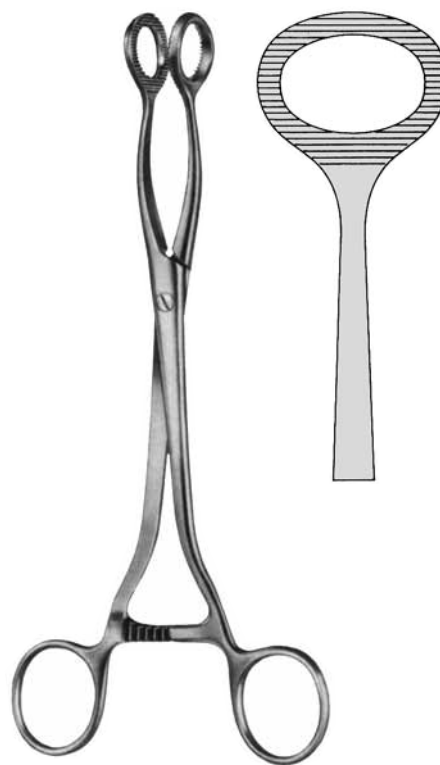

DOYEN
50.0330
20 cm



BALLENGER

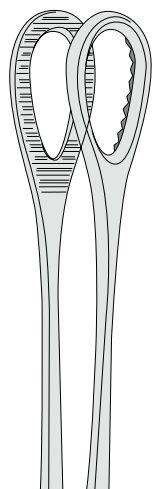

16.0416 25 cm

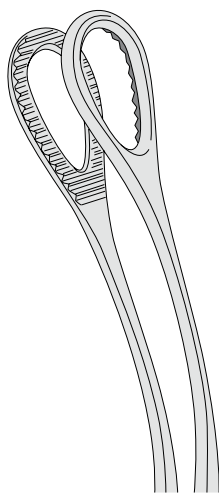

16.0417 25 cm



DEBAKEY



15.1580
25 cm



15.1582
27 cm

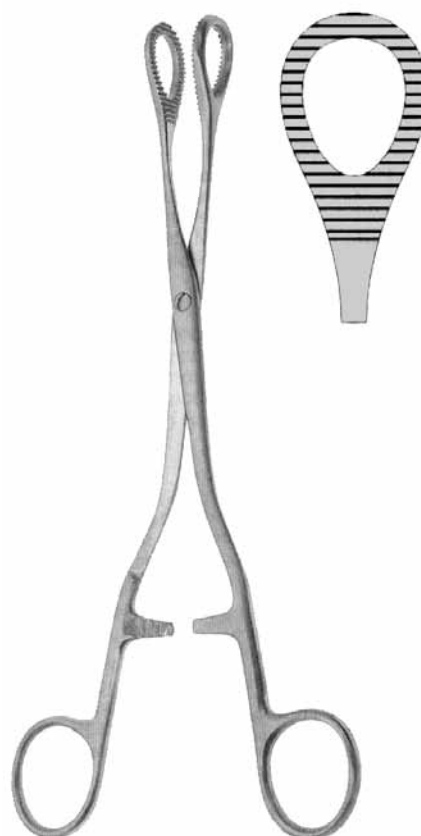

HEYWOOD-SMITH

56.0880 21 cm

56.0882 25 cm



POTTS-DE-MARTEL

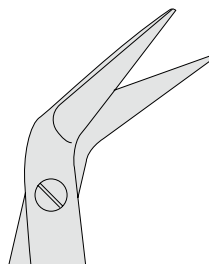

13.1180 21 cm /60°
13.1182 24 cm /60°

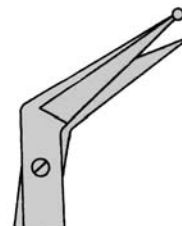

MILLS

13.1190 18 cm /60°
13.1192 22 cm /60°
1 Blatt geknöpft
1 probe-pointed blade
1 lame boutonée
1 hoja botonada
1 lama bottonuta



POTTS-SMITH

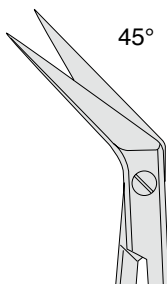

POTTS-SMITH
13.5601 19 cm



DEBAKEY

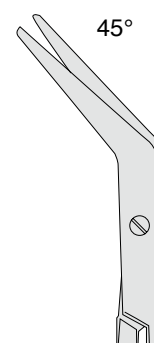

DEBAKEY
13.5621 23 cm



KELLY
26 cm
17.1118 160 x 38 mm
17.1119 160 x 57 mm
17.1093 190 x 38 mm
17.1094 190 x 57 mm



MIKULICZ
24 cm
17.1166 95 x 35 mm



MIKULICZ
26 cm
17.1167 120 x 50 mm
17.1168 155 x 50 mm
17.1169 180 x 50 mm



PITTSBURG

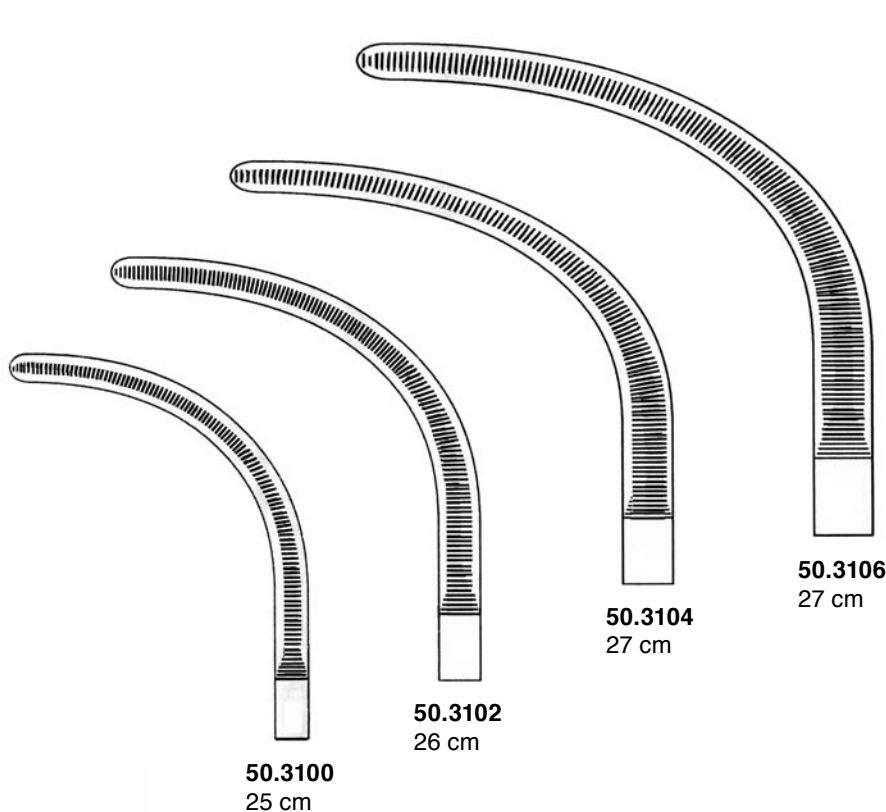



für Leberblindpunktion, mit Stoppsonde
for liver blind puncture, with stopping probe
pour ponction aveugle du foie, avec clou d'arrêt
para punción ciega del hígado, con aguja limitadora
per puntatura con ago limitatore

MENGHINI

- 19.3000** 1,00 x 35 mm
- 19.3001** 1,00 x 70 mm
- 19.3010** 1,20 x 70 mm
- 19.3011** 1,20 x 100 mm
- 19.3020** 1,40 x 70 mm
- 19.3021** 1,40 x 100 mm
- 19.3030** 1,60 x 70 mm
- 19.3040** 1,80 x 80 mm
- 19.3041** 1,80 x 100 mm



für gezielte Leberpunktion
for controlled liver pucture
pour ponction contrôlée du foie
para punción controlada del hígado
per puntatura controllata del fegato

MENGHINI

- 19.3043** 1,40 x 168 mm
- 19.3044** 1,80 x 168 mm



FRANKLIN-SILVERMAN

- 19.3051** 2,0 x 100 mm
- 19.3053** 2,5 x 145 mm

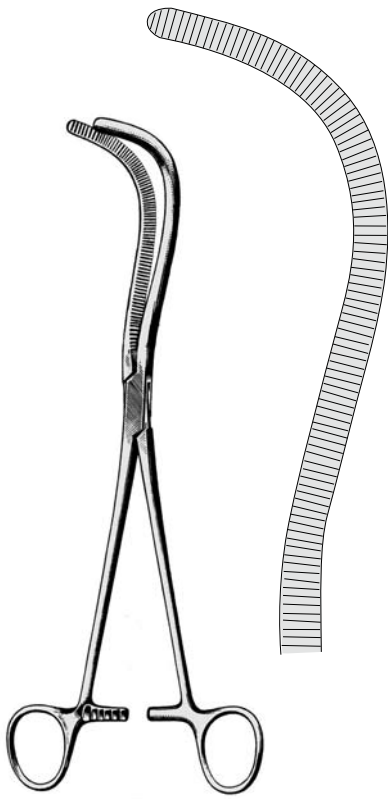

MAYO-GUYON
15.1930 23 cm

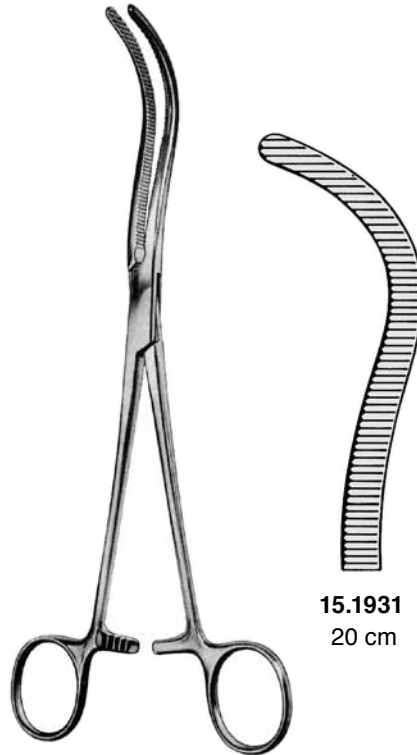

15.1931
20 cm

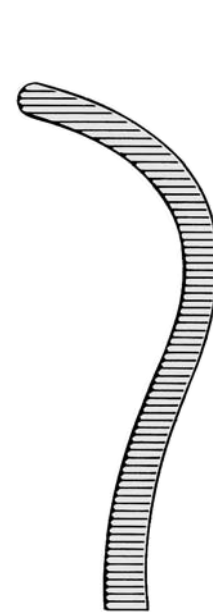

15.1933
22 cm

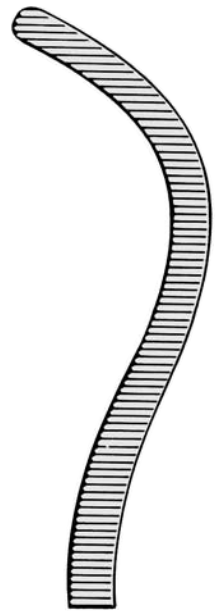

15.1935
24 cm



GUYON
15.1937 23 cm

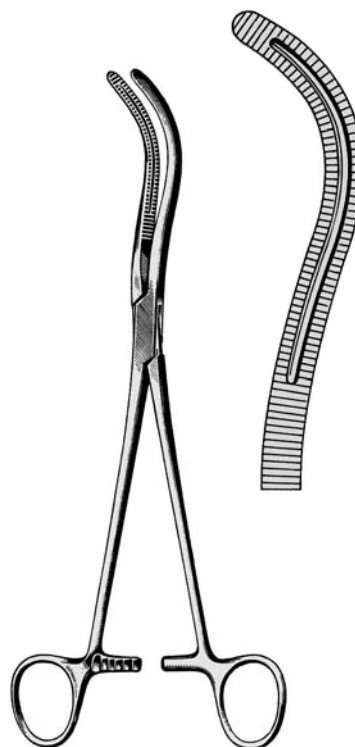

STILLE
15.1940 23 cm

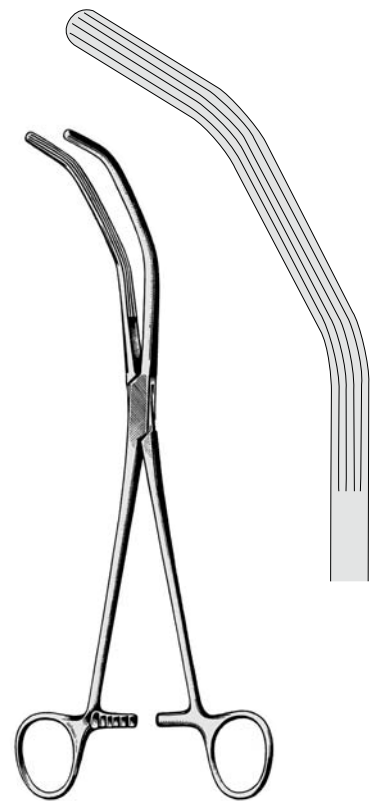

HERRICK
15.1960 23 cm

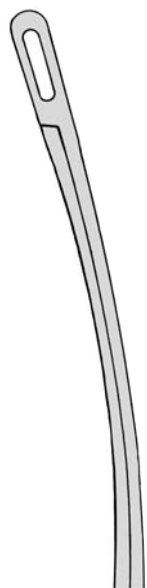

50.0340
 23 cm #1

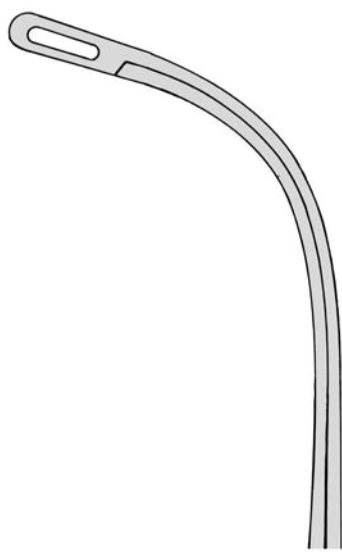

50.0342
 21 cm #2

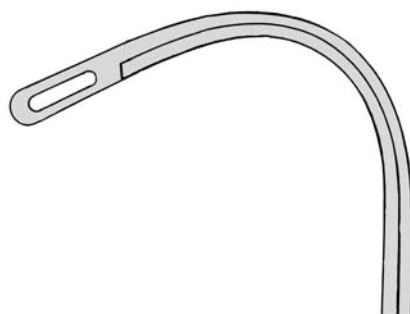

50.0344
 19 cm #3

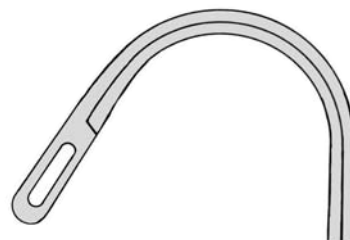

50.0346
 18 cm #4



1



2

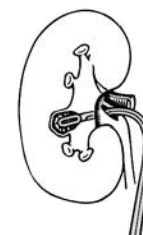

3



4

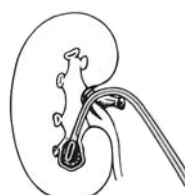

5 / 6

RANDALL

50.0347

Satz #1-4 / Set #1-4 /

Jeu #1-4 / Juego #1-4 / Serie di #1-4



RANDALL

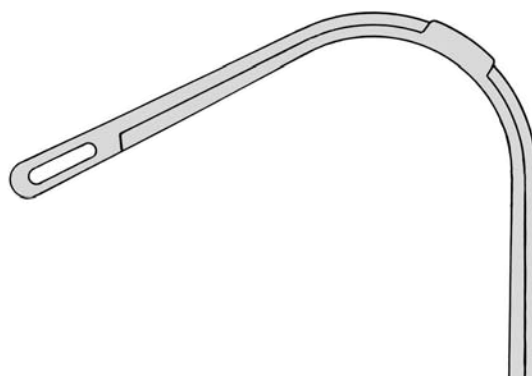

50.0348
 19 cm #5

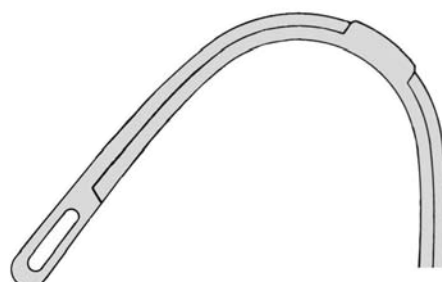

50.0350
 19 cm #6

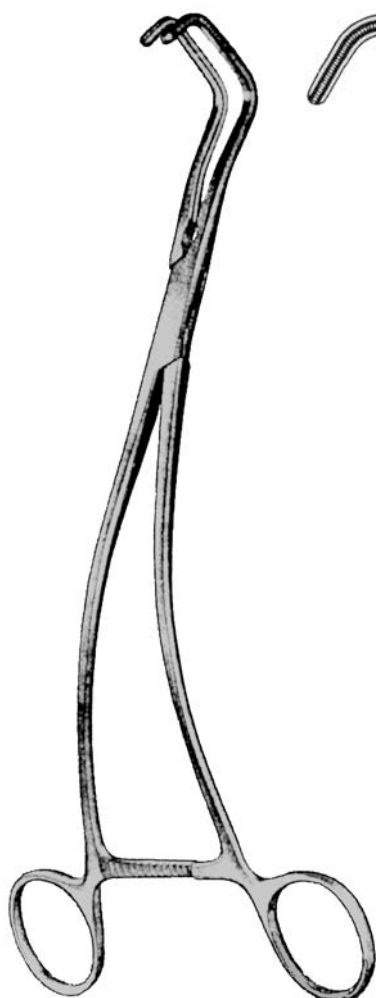

URO
24 cm

Ureterzangen
Ureter Forceps
Pincés pour urètère
Pinzas para uréter
Pinze per uretere



50.0401
1

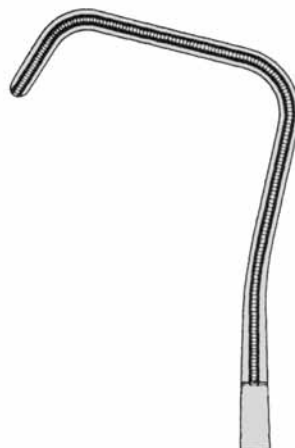

50.0402
2



DARTIGUES
55.1520
27 cm

Nierenfaßzange
Kidney elevating forceps
Hystérolabe
Pinza para sostener el riñón
Pinze per afferare il rene



MARBERGER
20 cm



17.0671 8 mm



17.0672 11 mm



17.0673 15 mm



17.0674 17 mm



17.0675 20 mm



17.0676 23 mm

biegsam
 malleable
 malléable
 maleable
 malleabili



GIL-VERNET
24 cm



17.0680 9 mm



17.0681 11 mm



17.0682 13 mm



17.0683 15 mm



17.0684 18 mm

biegsam
 malleable
 malléable
 maleable
 malleabili

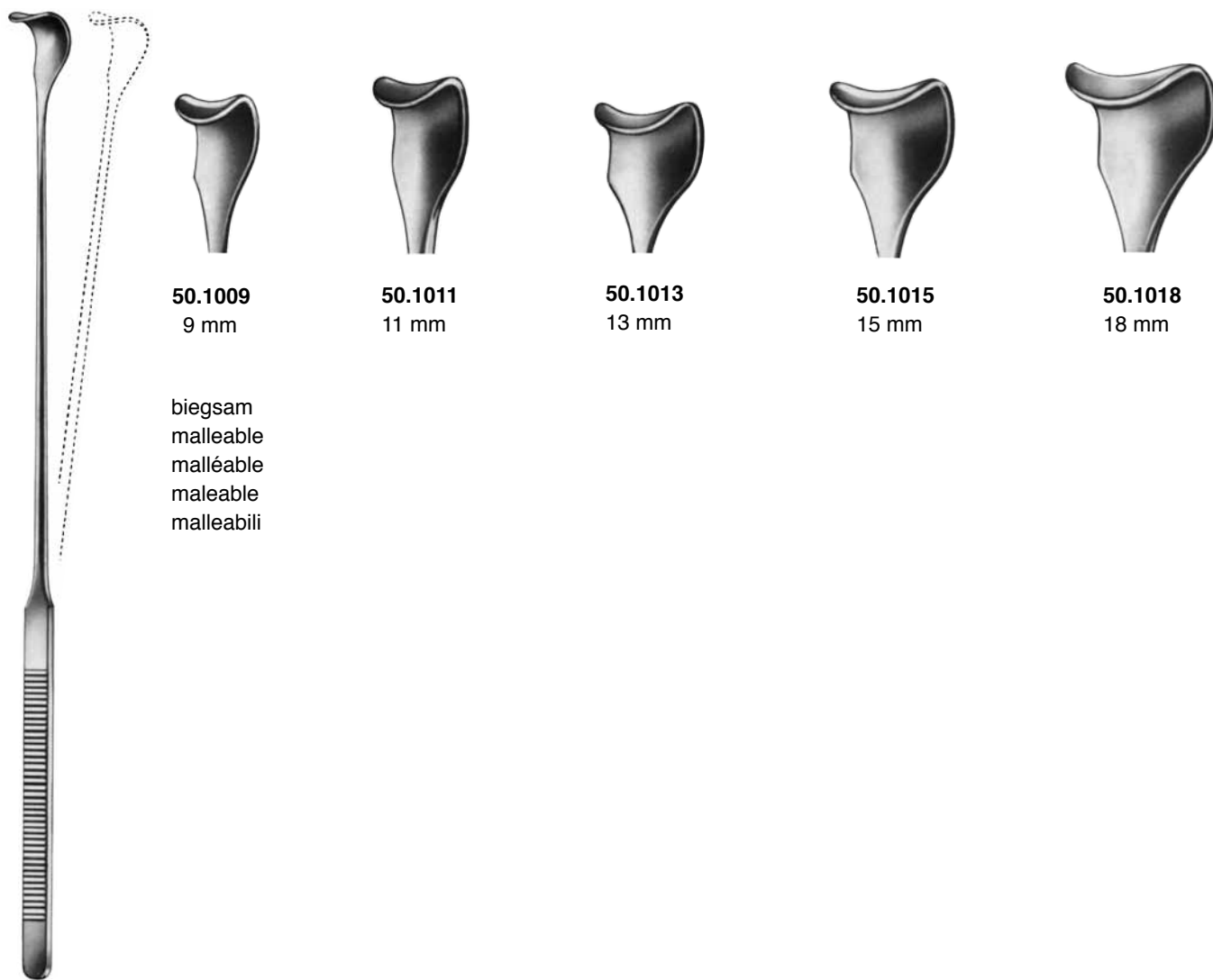

50.1009
9 mm

50.1011
11 mm

50.1013
13 mm

50.1015
15 mm

50.1018
18 mm

biegsam
malleable
malléable
maleable
malleabili

GIL-VERNET
28 cm

UROLOGIE
UROLOGY
UROLOGIE
UROLOGIA
UROLOGIA



Empfohlene Operationsbestecke für den Bereich "UROLOGIE"
(Details erhalten Sie über Ihren Fachhändler)

Suggested Instrument Sets for „UROLOGY“
(Please ask your dealer for details)

Suggestions de boîtes opératoires pour le secteur "UROLOGIE".
(Pour plus de détails veuillez contacter votre distributeur.)

Cajas quirurgicas para "UROLOGIA" (para detalles póngase en contacto con su distribuidor)

Strumentari raccomandati per "UROLOGIA"
(Per ulteriori informazioni, vi preghiamo di contattare il Vostro rivenditore)

- SET 51.0100** Urology Basic Instrument Set
- SET 51.0200** Urology Paediatric Basic Instrument Set
- SET 51.0300** Bladder Operating Set (Basic)
- SET 51.1000** Urology – Stones Set
- SET 51.1500** Prostatectomy Set
- SET 51.1550** Perineal Prostatectomy Set
- SET 51.1600** Supra-Retropubic Prostatectomy Set
- SET 51.2000** Urethral Dilation Inter Urethrotomy Set
- SET 51.2100** Meatotomy Set
- SET 51.2200** Orchiectomy Set
- SET 51.2300** Cystoscopy Basic Set
- SET 51.2500** Epispadias Repair Set
- SET 51.3000** Vasectomy Set
- SET 51.3100** Vasectomy Set "Non-Scalpel"
- SET 51.5000** Circumcision Set - Adult
- SET 51.5100** Circumcision Set - Newborn

Prostata-Fasszange
 Prostatic grasping forceps
 Pince à saisir la prostate
 Pinza para coger prostata
 Pinza per afferare la prostata

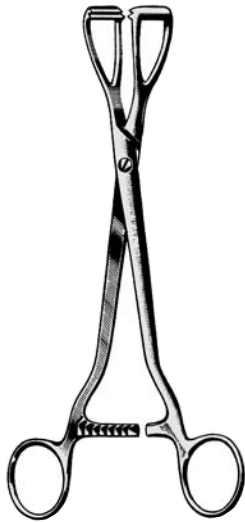

YOUNG
 51.0004
 20 cm

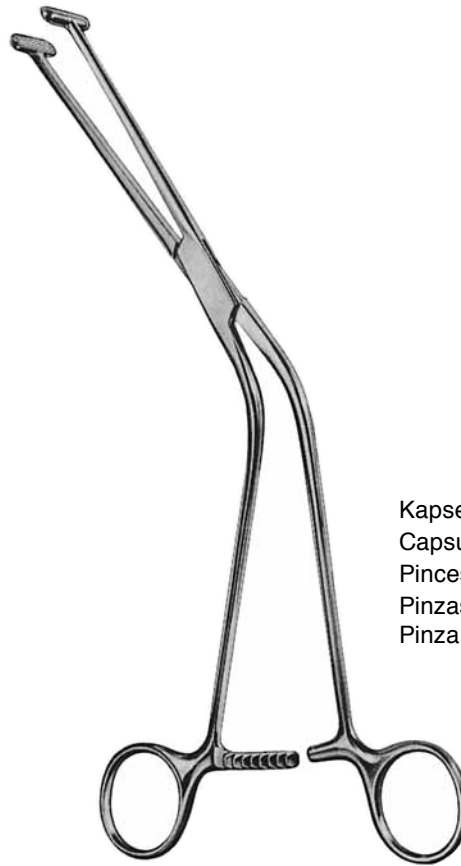

MILLIN
 23 cm

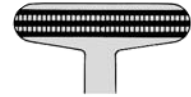

51.0009

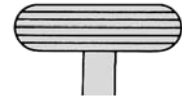

51.0010

Kapselasszangen
 Capsule forceps
 Pincés pour saisir les capsules
 Pinzas para coger capsulas
 Pinza per afferare la prostata

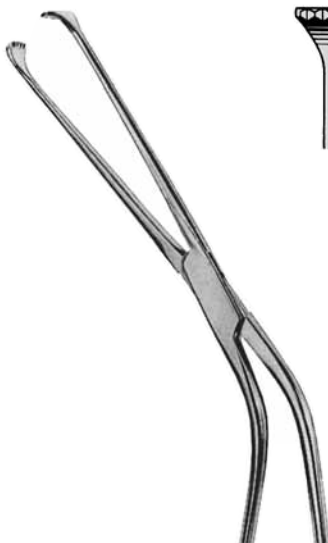

MILLIN
 51.0011
 23 cm



für die vorderen Lappen
 for anterior lobes
 pour lobe antérieur
 para lobo anterior
 per lobuli anteriori

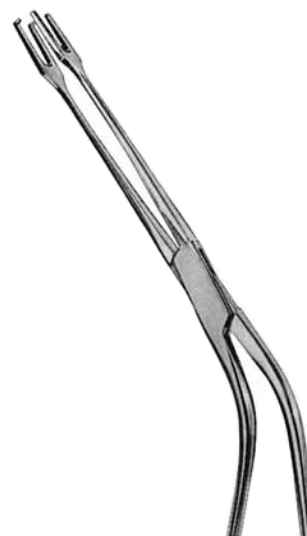

MILLIN
 51.0015
 23 cm

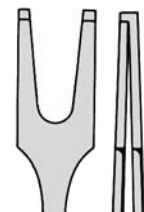

Fadenführungs-
 zange
 Ligatur carrier
 Porte-ligature
 Porta-ligaduras
 Pinza porta filo

Blasenhalsspreizer
Bladder neck spreader
Ecarteur pour col vésical
Dilatador para el cuello vesical
Divaricatore per collo vescicale



MILLIN
51.0020
24 cm

Samenstrang-Fixierklemme
Spermatic cord fixation clamp
Pince pour fixer le canal déférent
Pinza-fixajion canal espermatica
Pinza per fissare cordone spermatico



SPERMATIC
51.0040
14,5 cm

Ureterklemmen
Ureter clamps
Pinces à urètere
Pinzas clamps para ureter
Pinze per uretere

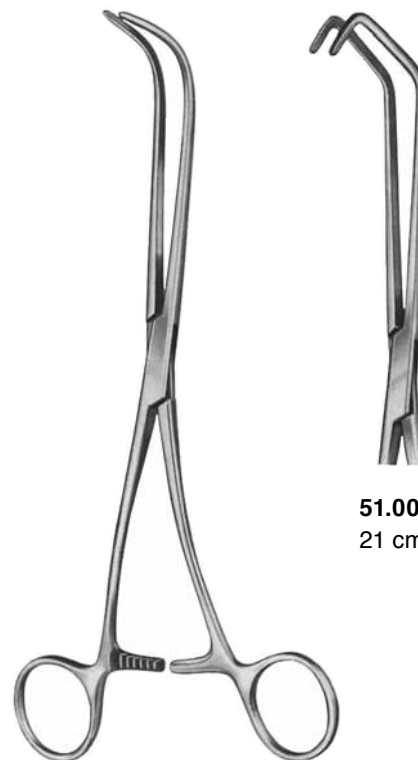

51.0042
21 cm #2

LURZ
51.0041
21 cm #1

Prostatahaken
Prostatic Retractors
Ecarteurs à prostate
Sparadores para prostata
Reptrattori prostatici



35 mm

LEGUEU
51.0050
27 cm / 35 mm



67 mm

KOCHER
51.0053
26 cm / 67 mm

Prostatahaken
Prostatic Retractors
Ecarteurs à prostate
Sparadores para prostata
Re Trattori prostatici

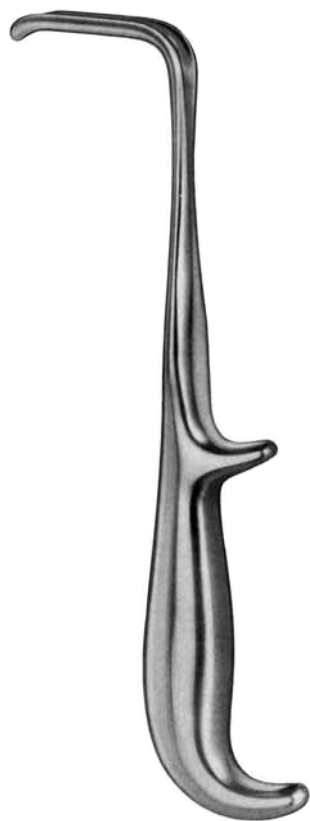

YOUNG
51.0055
21 cm

lateral
lateral
latéral
lateral
laterale



YOUNG
51.0056
22 cm

anterior
anterior
antérieur
anterior
anteriore



YOUNG
51.0057
21 cm

Bulbus-Haken
Bulbus hook
Crochet à bulbus
Gancho para el bulbus
Uncino per bulbo



YOUNG
51.0058
22 cm

gegabelt
forked
en fourhce
horquilla
a forchetta

Vasektomieklemmen / Vasectomy Clamps / Pinces pour Vasectomie / Pinzas para vasectomia / Pinze per Vasectomia



51.0043
14 cm Ø 3,0 mm



51.0044
14 cm Ø 4,7 mm



51.0045
12,5 cm
gebogen, spitz
curved, sharp
courbe, pointu
curva, agudo
curvo, acuto

Samenstranghaken / Spermatic cord hooks / Crochets pour cordon spermatique /
Ganchos para cordón espermático / Uncini per cordone spermatico



SPERMATIC
51.0060
16 cm

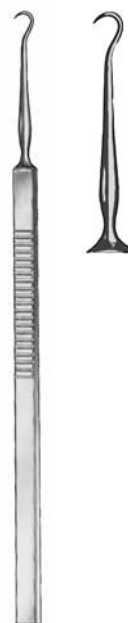

17.0001
16 cm



MILLIN
51.0020
28 cm

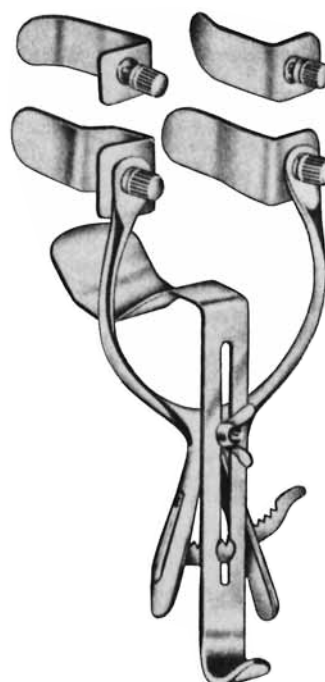

MILLIN
51.0080

komplett, mit 2 Seitenvälven 57x25 mm und 80x25 mm, 1 Mittelvalve 120x45 mm
complete, with 2 lateral valves 57x25 mm and 80x25 mm, 1 center blade 120x45 mm
complet, avec 2 valves latérales 57x25 mm et 80x25 mm, 1 valve centrale 120x45 mm
completo, con 2 valvas laterales 57x25 mm y 80x25 mm, 1 valva central 120x45 mm
completo, con 2 valve laterali 57x25 mm e 80x25 mm, 1 valva centrale 120x45 mm



JUDD-MASSON
51.0070

Spreizweite 100 mm
spread 100 mm
ouverture 100 mm
apertura 100 mm
apertura 100 mm



JUDD-MASSON

51.0072

komplett, mit 2 Seitenvalven 70x25 mm und 1 Mittelvale 84x24 mm
complete, with 2 lateral valves 70x25 mm and 1 center blade 84x24 mm
complet, avec 2 valves latérales 70x25 mm et 1 valve centrale 84x24 mm
completo, con 2 valvas laterales 70x25 mm y 1 valva central 84x24 mm
completo, con 2 valve laterali 70x25 mm e 1 valva centrale 84x24 mm

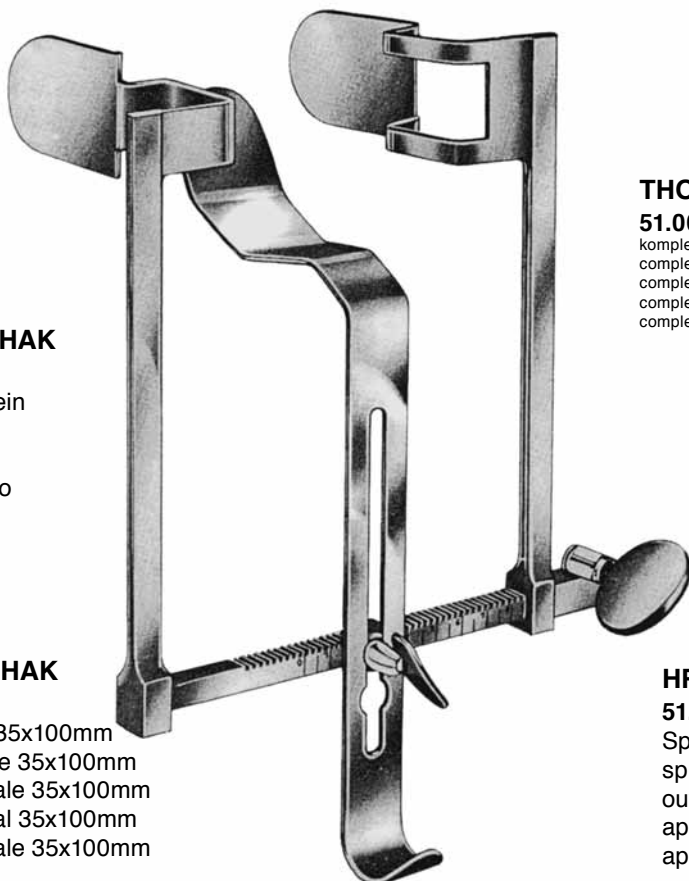

HRYNTSCHAK

51.0098

Rahmen allein
Frame only
Cadre seul
Bastidor solo
Telaio solo

HRYNTSCHAK

51.0099

Mittelvalve 35x100mm
Center blade 35x100mm
Valve centrale 35x100mm
Valva central 35x100mm
Valva centrale 35x100mm

THOMSON-WALKER

51.0090

komplett, mit 2 Seitenvalven 70x25 mm und 75x25 mm, 1 Mittelvale 90x25 mm
complete, with 2 lateral valves 70x25 mm and 75x25 mm, 1 center blade 90x25 mm
complet, avec 2 valves latérales 70x25 mm et 75x25 mm, 1 valve centrale 90x25 mm
completo, con 2 valvas laterales 70x25 mm y 75x25 mm, 1 valva central 90x25 mm
completo, con 2 valve laterali 70x25 mm e 75x25 mm, 1 valva centrale 90x25 mm

HRYNTSCHAK

51.0097

Spreizweite 110 mm
spread 110 mm
ouverture 110 mm
apertura 110 mm
apertura 110 mm

für Männer
 for men
 pour hommes
 para hombres-
 per uomini

fur Frauen
 for women
 pour femmes
 para mujeres
 per donne



- 51.0106 6 Fr.
- 51.0107 7 Fr.
- 51.0108 8 Fr.
- 51.0109 9 Fr.
- 51.0110 10 Fr.
- 51.0112 12 Fr.
- 51.0114 14 Fr.
- 51.0116 16 Fr.
- 51.0118 18 Fr.
- 51.0120 20 Fr.
- 51.0122 22 Fr.
- 51.0124 24 Fr.



- 51.0136 6 Fr.
- 51.0137 7 Fr.
- 51.0138 8 Fr.
- 51.0139 9 Fr.
- 51.0140 10 Fr.
- 51.0141 11 Fr.
- 51.0142 12 Fr.
- 51.0143 13 Fr.
- 51.0144 14 Fr.
- 51.0145 15 Fr.
- 51.0146 16 Fr.
- 51.0148 18 Fr.
- 51.0150 20 Fr.
- 51.0152 22 Fr.
- 51.0154 24 Fr.

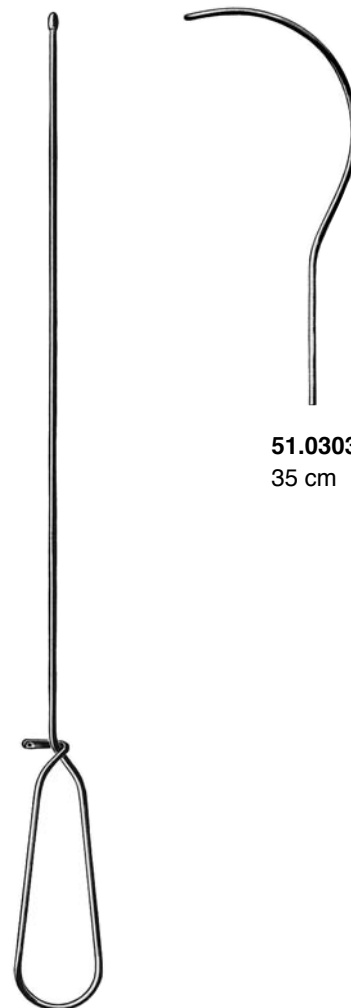

51.0303
 35 cm

GUYON
51.0302
 39 cm



GUTTMAN
 51.0350
 26 cm



Sekretlöffel biegsam
 Secretion curette, malleable
 Cuillère pour sécrétions, malleable
 Cucharilla para secreción, maleable
 Curetta per secrezioni, malleabile



STOCKMANN
 51.0600

Penisklemmen
 Penis Clamps
 Pincés pour pénis
 Pinzas para pene
 Pinze serrapene



STRAUSS
 51.0610

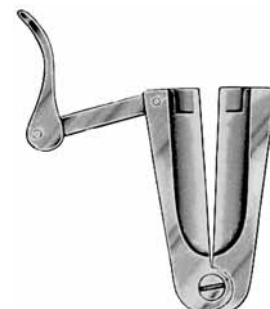

MOGEN
 51.0720
 7,5 cm

Beschneidungsinstrument
 Circumcision instrument
 Instrument de circoncision
 Instrumento para circoncisión
 Strumento per circoncisione

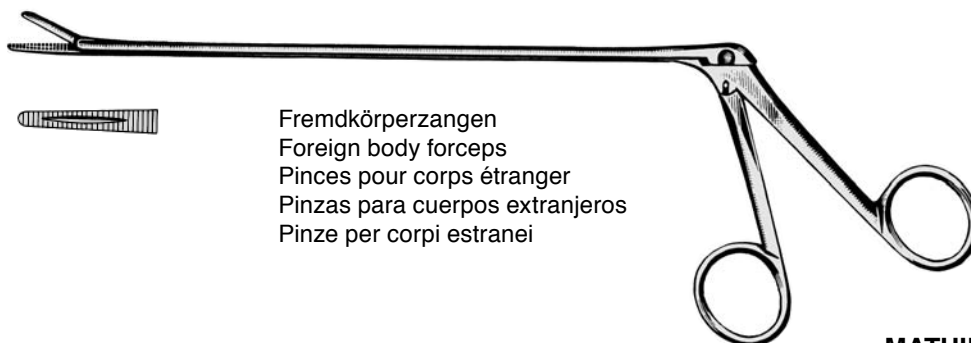

Fremdkörperzangen
 Foreign body forceps
 Pincés pour corps étranger
 Pinzas para cuerpos extranjeros
 Pinze per corpi estranei

MATHIEU
 51.0800 20 cm
 51.0802 28 cm

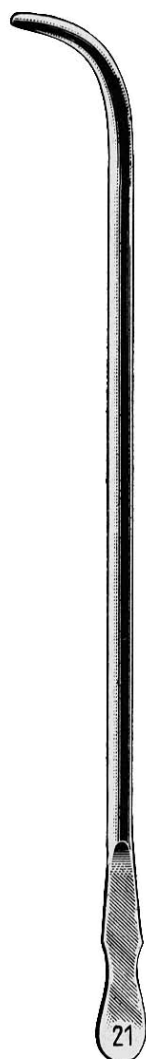

VAN BUREN

28 cm

- 51.1008** 8 Fr.
- 51.1010** 10 Fr.
- 51.1012** 12 Fr.
- 51.1014** 14 Fr.
- 51.1016** 16 Fr.
- 51.1018** 18 Fr.
- 51.1020** 20 Fr.
- 51.1022** 22 Fr.
- 51.1024** 24 Fr.
- 51.1026** 26 Fr.
- 51.1028** 28 Fr.
- 51.1030** 30 Fr.
- 51.1032** 32 Fr.
- 51.1034** 34 Fr.
- 51.1036** 36 Fr.

51.1040 8 - 36 Fr.

Satz / set / jeu / juego / serie

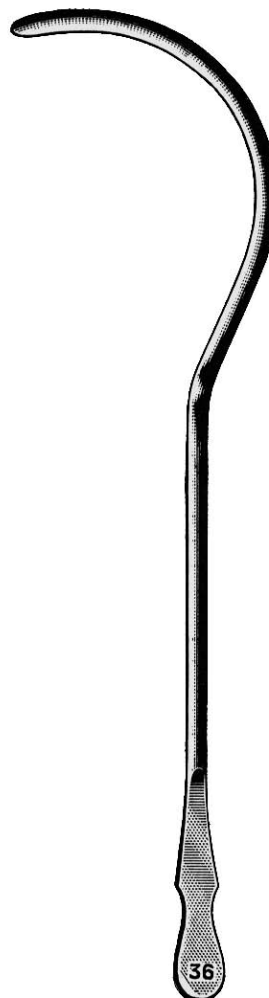

GUYON

26 cm

- 51.1107** 7Fr.
- 51.1108** 8Fr.
- 51.1109** 9Fr.
- 51.1110** 10 Fr.
- 51.1111** 11 Fr.
- 51.1112** 12 Fr.
- 51.1113** 13 Fr.
- 51.1114** 14 Fr.
- 51.1115** 15 Fr.
- 51.1116** 16 Fr.
- 51.1117** 17 Fr.
- 51.1118** 18 Fr.
- 51.1119** 19 Fr.
- 51.1120** 20 Fr.
- 51.1121** 21 Fr.
- 51.1122** 22 Fr.
- 51.1123** 23 Fr.
- 51.1124** 24 Fr.
- 51.1125** 25 Fr.
- 51.1126** 26 Fr.
- 51.1127** 27 Fr.
- 51.1128** 28 Fr.
- 51.1129** 29 Fr.
- 51.1130** 30 Fr.

51.1140 10 - 30 Fr.

Satz / set / jeu / juego / serie

GYNÄKOLOGIE
GYNECOLOGY
GYNECOLOGIE
GINECOLOGIA
GINECOLOGIA

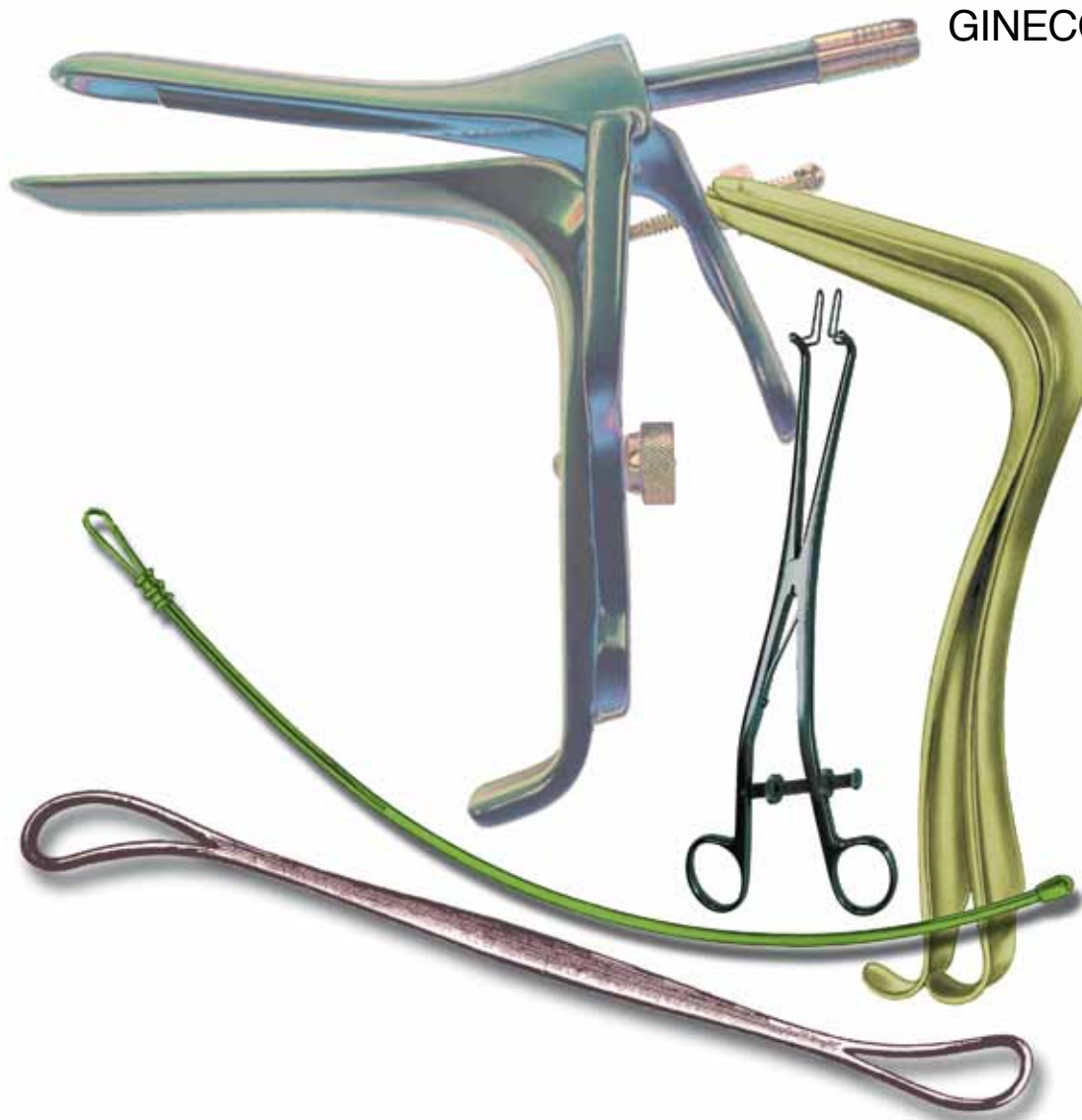

Empfohlene Operationsbestecke für den Bereich "GYNÄKOLOGIE"
(Details erhalten Sie über Ihren Fachhändler)

Suggested Instrument Sets for „GYNECOLOGY“
(Please ask your dealer for details)

Suggestions de boîtes opératoires pour le secteur "GYNECOLOGIE".
(Pour plus de détails veuillez contacter votre distributeur.)

Cajas quirurgicas para "GINECOLOGIA" (para detalles póngase en contacto con su distribuidor)

Strumentari raccomandati per "GINECOLOGIA"
(Per ulteriori informazioni, vi preghiamo di contattare il Vostro rivenditore)

- SET 55.0010** Gynaecological Ward Treatment Set
- SET 55.0020** Gynaecological Examination Set
- SET 55.0100** Colposcopy Set
- SET 55.0200** Dilation & Curetage Set
- SET 55.0220** Hysteroscopy Set Basic
- SET 55.0300** Gynaecologic Set
- SET 55.0400** Abdominal Gynaecological Set
- SET 55.1000** Abdominal Hysterectomy Set
- SET 55.1100** Vaginal Hysterectomy Set
- SET 55.1200** Cone Biopsy Set
- SET 55.1300** Gynaecology Laparotomy Set
- SET 55.1400** Basic Vaginal Instrument Set
- SET 55.1450** Vaginal Repair Set
- SET 55.1500** Vaginal Closure Set
- SET 55.1600** Tubal Plasty Set
- SET 55.1650** Open Tubal Surgery Set
- SET 55.1700** Salpingostomy Set
- SET 55.1800** Perineal Plastic Set
- SET 55.1900** Radical Vulvectomy Set
- SET 55.1950** Colpotomy Set
- SET 55.2000** Cervical Biopsy Set
- SET 55.2100** Uterine Biopsy Set
- SET 55.2200** Bartholin Cyst Excision Set
- SET 55.2300** Vaginal Repair Set
- SET 55.2350** Vesicovaginal Fistula Repair Set
- SET 55.2400** Anterior / Posterior Colporrhaphy Set
- SET 55.2500** Parametrial Fixation Set
- SET 55.3000** IUD Insertion & Extraction Set



CUSCO
55.0010 75 x 17 mm
für Jungfrauen
for virgins
pour vierges
para virgenes
per vergini



COLLIN
55.0025 55 x 10 mm
für Kinder
child size
pour enfants
para niños
per bambine



PEDERSON
55.0040 75 x 13 mm

konische Blätter, für Jungfrauen
tapered blades, for virgins
valves coniques, pour vierges
hojas cónicas, para vírgenes
valve coniche, per vergini



KRISTELLER

21 cm

55.0230 110 x 18 mm # 00

55.0231 110 x 21 mm # 0



KRISTELLER

21 cm

55.0233 115 x 14 mm # 00

55.0234 115 x 17 mm # 0



KRISTELLER

Satz / set / jeu / juego

55.0236 110 x 18 mm # 00

55.0237 110 x 21 mm # 0



55.3530

VAGINOSKOP 65 x Ø 10 mm mit Kaltlicht-Anschluss
ACMI,WOLF,STORZ

VAGINOSCOPE 65 x Ø 10 mm with Cold-light attachment
(ACMI,WOLF,STORZ)

VAGINOSCOPE 65 x Ø 10 mm avec lumière froide
(ACMI,WOLF,STORZ)

VAGINOSCOPIO 65 x Ø 10 mm con alumbrado frio
(ACMI,WOLF,STORZ)

VAGINOSCOPIO 65 x Ø 10 mm fibra ottica (ACMI,WOLF,
STORZ)

48.1249

Kaltlicht Beleuchtungsstab für Proktoskope, Analspreizer mit
ACMI, STORZ, WOLF Anschluß

Fibre Optic Light attachment for Rectoscopes and -spreaders
with connectors for ACMI, STORZ, WOLF

Embout lumière froide pour Proctoscopes, Ecarteurs rectaux,
lumière froide avec adaptateur ACMI, STORZ, WOLF

Adaptador luz fria para Proctoscopios, Separadores rectales
con adaptadores ACMI, STORZ, WOLF

Inserto per Proctoscopi, Divaricatori rettali a fibra ottica con
adattatore ACMI, STORZ, WOLF



CUSCO

- | | | |
|----------------|-------------|------------------|
| 55.0014 | 90 x 23 mm | Schweizer Modell |
| 55.0015 | 100 x 25 mm | Swiss pattern |
| 55.0016 | 110 x 27 mm | Modèle suisse |
| | | Modelo suizo |
| | | Modello svizzero |



CUSCO

- | | | |
|----------------|-------------|------------------|
| 55.0017 | 75 x 32 mm | Mittelschraube |
| 55.0018 | 85 x 35 mm | Center screw |
| 55.0019 | 100 x 37 mm | Vis centrale |
| | | Tornillo central |
| | | Vite centrale |



CUSCO

55.0011 75 x 32 mm

55.0012 85 x 35 mm

55.0013 100 x 37 mm



CUSCO

55.0011B 75x32 mm

55.0012B 85x35 mm

55.0013B 100x37 mm

blendfrei - für LASER Chirurgie, mit Rauchabsaugung
antiglare - for LASER Surgery - with smoke evacuation
antiréfléchissant - pour chirurgie LASER, avec aspiration de la fumée
antideslumbrante - para cirugía LASER, con aspiración de humo
antiabbagliante - per chirurgia LASER, con aspirazione di fumo



CUSCO

55.0011HF 75x32 mm

55.0012HF 85x35 mm

55.0013HF 100x37 mm

isoliert - für HF-Chirurgie, mit Rauchabsaugung
insulated - for HF Surgery, with smoke evacuation
isolés - pour chirurgie HF, avec aspiration de la fumée
aislados - para cirugía HF, con aspiración de humo
asolari - per chirurgia HF, con aspirazione di fumo

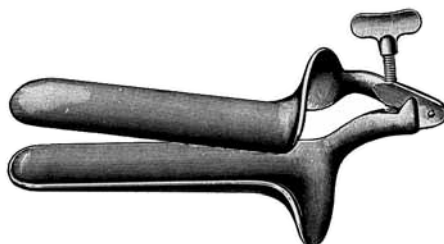

COLLIN

55.0020 85 x 30 mm

55.0021 100 x 35 mm

55.0022 110 x 40 mm



COLLIN

55.0020B 85x30 mm

55.0021B 100x35 mm

55.0022B 110x40 mm

blendfrei - für LASER Chirurgie, mit Rauchabsaugung
antiglare - for LASER Surgery - with smoke evacuation
antiréfléchissant - pour chirurgie LASER, avec aspiration de la fumée
antideslumbrante - para cirugía LASER, con aspiración de humo
antiabbagliante - per chirurgia LASER, con aspirazione di fumo



COLLIN

55.0020HF 85x30 mm

55.0021HF 100x35 mm

55.0022HF 110x40 mm

isoliert - für HF-Chirurgie, mit Rauchabsaugung
insulated - for HF Surgery, with smoke evacuation
isolés - pour chirurgie HF, avec aspiration de la fumée
aislados - para cirugía HF, con aspiración de humo
asolari - per chirurgia HF, con aspirazione di fumo



GRAVE

55.0030 75 x 20 mm

55.0031 95 x 30 mm

55.0032 115 x 35 mm



GRAVE

55.0030B 75x20 mm

55.0031B 95x30 mm

55.0032B 115x35 mm

blendfrei - für LASER Chirurgie, mit Rauchabsaugung
antiglare - for LASER Surgery - with smoke evacuation
antiréfléchissant - pour chirurgie LASER, avec aspiration de la fumée
antideslumbrante - para cirugía LASER, con aspiración de humo
antiabbagliante - per chirurgia LASER, con aspirazione di fumo



GRAVE

55.0030HF 75x20 mm

55.0031HF 95x30 mm

55.0032HF 115x35 mm

isoliert - für HF-Chirurgie, mit Rauchabsaugung
insulated - for HF Surgery, with smoke evacuation
isolés - pour chirurgie HF, avec aspiration de la fumée
aislados - para cirugía HF, con aspiración de humo
asolari - per chirurgia HF, con aspirazione di fumo



PEDERSON

55.0040 75 x 13 mm

55.0041 100 x 22 mm

55.0042 120 x 25 mm

55.0045 100 x 16 mm



PEDERSON

55.0040B 75x13 mm

55.0041B 100x22 mm

55.0042B 120x25 mm

blendfrei - für LASER Chirurgie, mit Rauchabsaugung
antiglare - for LASER Surgery - with smoke evacuation
antiréfléchissant - pour chirurgie LASER, avec aspiration de la fumée
antideslumbrante - para cirugía LASER, con aspiración de humo
antiabbagliante - per chirurgia LASER, con aspirazione di fumo



PEDERSON

55.0040HF 75x13 mm

55.0041HF 100x22 mm

55.0042HF 120x25 mm

isoliert - für HF-Chirurgie, mit Rauchabsaugung
insulated - for HF Surgery, with smoke evacuation
isolés - pour chirurgie HF, avec aspiration de la fumée
aislados - para cirugía HF, con aspiración de humo
asolari - per chirurgia HF, con aspirazione di fumo

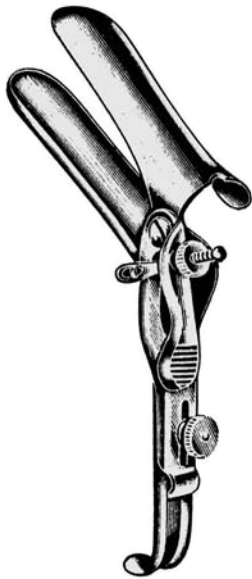

GRAVE

55.0036 45° 100x35 mm
rechte Seite offen
right side open
ouvert à droit
abierto a la derecha
aperto sulla destra

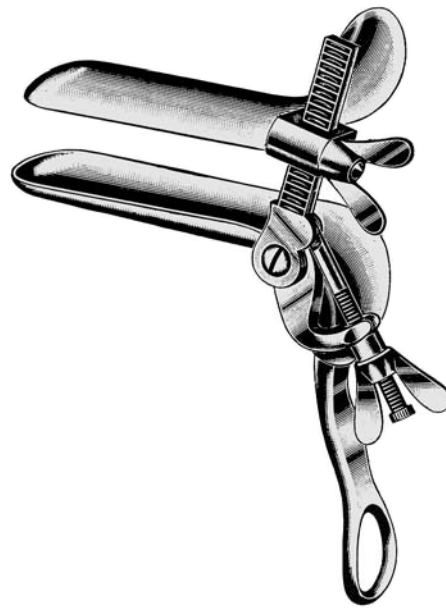

TRELAT

55.0050 85 x 33 mm
55.0051 95 x 35 mm
55.0052 115 x 43 mm



SEYFFERT

55.0060 100 x 17 mm
55.0062 110 x 33 mm



SEMM

55.0066 90 x 40/18 mm
55.0067 100 x 17/20 mm
55.0068 110 x 25/30 mm



AUVARD

55.0100

55.0101

abnehmbares Gewicht
detachable weight
poids démontable
peso desmontable
peso smontabile

80 x 38 mm

100 x 38 mm

140 x 32 mm

AUVARD

55.0102

55.0103

55.0105

festes Gewicht
fixed weight
poids fixe
pesa fija
peso fisso



SCHERBAK
55.0112



SCHERBAK

- 55.0116 # 1, 80 x 30 mm
- 55.0117 # 2, 85 x 35 mm
- 55.0118 # 3, 90 x 40 mm



SCHERBAK

- 55.0119 # 4, 40/60 x 55 mm
- 55.0120 # 5, 45/70 x 70 mm

SCHERBAK

55.0110

Scheidenspekulum, Satz komplett, bestehend aus:

- 55.0112 Griff
- 55.0113 Gewicht 400 g.
- 55.0116 Valve # 1, 80 x 30 mm
- 55.0117 Valve # 2, 85 x 35 mm
- 55.0118 Valve # 3, 90 x 40 mm
- 55.0119 Valve # 4, 40/60 x 55 mm

Vaginal Speculum, complete Set consisting of:

- 55.0112 Handle
- 55.0113 Weight 400 gr.
- 55.0116 Valve # 1, 80 x 30 mm
- 55.0117 Valve # 2, 85 x 35 mm
- 55.0118 Valve # 3, 90 x 40 mm
- 55.0119 Valve # 4, 40/60 x 55 mm

Spéculum vaginal, jeu complet, comprenant:

- 55.0112 Manche
- 51.0113 Poids 400 g.
- 55.0116 Valve # 1, 80 x 30 mm
- 55.0117 Valve # 2, 85 x 35 mm
- 55.0118 Valve # 3, 90 x 40 mm
- 55.0119 Valve # 4, 40/60 x 55 mm

Espéculo vaginal, juego completo, compuesto de:

- 55.0112 Mango
- 55.0113 Peso 400 gr.
- 55.0116 Valva # 1, 80 x 30 mm
- 55.0117 Valva # 2, 85 x 35 mm
- 55.0118 Valva # 3, 90 x 40 mm
- 55.0119 Valva # 4, 40/60 x 55 mm

Specolo vaginale, serie completa, composta da:

- 55.0112 Manico
- 55.0113 Peso 400 gr.
- 55.0116 Valva # 1, 80 x 30 mm
- 55.0117 Valva # 2, 85 x 35 mm
- 55.0118 Valva # 3, 90 x 40 mm
- 55.0119 Valva # 4, 40/60 x 55 mm

SCHERBAK

55.0111

Scheidenspekulum, Satz komplett, bestehend aus:

- 55.0112 Griff
- 55.0113 Gewicht 400 g.
- 55.0116 Valve # 1, 80 x 30 mm
- 55.0117 Valve # 2, 85 x 35 mm
- 55.0118 Valve # 3, 90 x 40 mm
- 55.0119 Valve # 4, 40/60 x 55 mm
- 55.0120 Valve # 5, 45/70 x 70 mm

Vaginal Speculum, complete Set consisting of:

- 55.0112 Handle
- 55.0113 Weight 400 gr.
- 55.0116 Valve # 1, 80 x 30 mm
- 55.0117 Valve # 2, 85 x 35 mm
- 55.0118 Valve # 3, 90 x 40 mm
- 55.0119 Valve # 4, 40/60 x 55 mm
- 55.0120 Valve # 5, 45/70 x 70 mm

Spéculum vaginal, jeu complet, comprenant:

- 55.0112 Manche
- 51.0113 Poids 400 g.
- 55.0116 Valve # 1, 80 x 30 mm
- 55.0117 Valve # 2, 85 x 35 mm
- 55.0118 Valve # 3, 90 x 40 mm
- 55.0119 Valve # 4, 40/60 x 55 mm
- 55.0120 Valve # 5, 45/70 x 70 mm

Espéculo vaginal, juego completo, compuesto de:

- 55.0112 Mango
- 55.0113 Peso 400 gr.
- 55.0116 Valva # 1, 80 x 30 mm
- 55.0117 Valva # 2, 85 x 35 mm
- 55.0118 Valva # 3, 90 x 40 mm
- 55.0119 Valva # 4, 40/60 x 55 mm
- 55.0120 Valva # 5, 45/70 x 70 mm

Specolo vaginale, serie completa, composta da:

- 55.0112 Manico
- 55.0113 Peso 400 gr.
- 55.0116 Valva # 1, 80 x 30 mm
- 55.0117 Valva # 2, 85 x 35 mm
- 55.0118 Valva # 3, 90 x 40 mm
- 55.0119 Valva # 4, 40/60 x 55 mm
- 55.0120 Valva # 5, 45/70 x 70 mm



SCHERBAK
55.0113 400 gr.
55.0114 600 gr.
55.0115 800 gr.



WEISSBARTH
55.0130 80 x 42 mm
20 cm



KRISTELLER

19 cm

- ★ 55.0190 70 x 15 mm
- 55.0200 70 x 27 mm
- 55.0201 75 x 30 mm
- 55.0202 90 x 36 mm

★ für Kinder
for children
pour enfants
para niños
per bambine



KRISTELLER

18 cm

- ★ 55.0193 70 x 15 mm
- 55.0203 75 x 23 mm
- 55.0204 80 x 26 mm
- 55.0205 95 x 32 mm



KRISTELLER

Satz / set / jeu / juego / Set

- ★ 55.0196 70 x 15 mm
- 55.0206 70 x 27 mm
- 55.0207 75 x 30 mm
- 55.0208 90 x 36 mm



flache Spekula
flat hollow specula
spéculums plats
especulos profundos
Specoli piatti



KRISTELLER

22 cm

55.0210 105 x 26 mm

55.0211 105 x 28 mm

55.0212 105 x 33 mm



KRISTELLER

22 cm

55.0213 115 x 22 mm

55.0214 115 x 24 mm

55.0215 115 x 29 mm



KRISTELLER

Satz / set / jeu / juego / Set

55.0216 105 x 26 mm

55.0217 105 x 28 mm

55.0218 105 x 33 mm

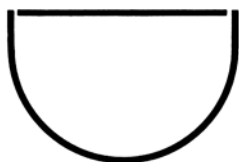

tiefe Spekula
deep hollow specula
spéculum profonds
especulos profundos
Specoli profondi



KRISTELLER

22 cm

55.0220 110 x 27 mm

55.0221 110 x 30 mm

55.0222 110 x 36 mm



KRISTELLER

22 cm

55.0223 115 x 23 mm

55.0224 115 x 26 mm

55.0225 115 x 32 mm



KRISTELLER

Satz / set / jeu / juego / Set

55.0226 110 x 27 mm

55.0227 110 x 30 mm

55.0228 110 x 36 mm

extra groß
extra large
extra grand
extra grande
extra grande



KRISTELLER
21 cm
55.0240 135 x 36 mm

KRISTELLER
21 cm
55.0243 140 x 30 mm

KRISTELLER
Satz / set / jeu / juego / Set
55.0246 135 x 36 mm



KALLMORGEN

55.0248

70 x 40 mm

Satz / set / Jeu / Juego / Set

KALLMORGEN

55.0250

70 x 40 mm

Spekula / Specula / Spéculum /
Espéculos / Specoli

55.0252

70 x 33 mm

Scheidenhalter / Vaginal Retractors / Valves
vaginales / Valvas vaginales / Valve vaginali



KALLMORGEN

55.0249

90 x 40 mm

Satz / set / Jeu / Juego / Set

KALLMORGEN

55.0251

90 x 40 mm

Spekula / Specula / Spéculum /
Espéculos / Specoli

55.0253

90 x 33 mm

Scheidenhalter / Vaginal Retractors / Valves
vaginales / Valvas vaginales / Valve vaginali

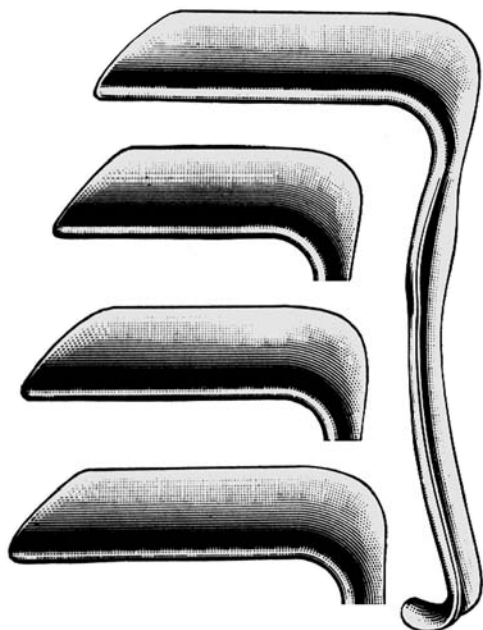

JACKSON

18 cm

55.0270 75 x 30 mm

55.0271 90 x 38 mm

55.0272 100 x 38 mm



EASTMAN

18 cm

55.0275 76 x 38 mm

55.0276 89 x 38 mm

55.0277 101 x 38 mm



SIMS

18 cm

55.0260 60 x 25 + 30 mm

55.0261 70 x 30 + 35 mm

55.0262 80 x 35 + 40 mm

55.0265 Satz / set / jeu / juego / Set



BREISKY

30 cm

- 55.0280 100 x 20 mm
- 55.0281 100 x 25 mm
- 55.0282 100 x 30 mm
- 55.0283 100 x 35 mm
- 55.0284 100 x 40 mm
- 55.0285 130 x 20 mm
- 55.0286 130 x 25 mm
- 55.0287 130 x 30 mm
- 55.0288 130 x 35 mm
- 55.0289 130 x 40 mm
- 55.0294 160 x 40 mm
- 55.0299 180 x 40 mm



LANDAU

30 cm

- 55.0310 100 x 28 mm
- 55.0311 110 x 38 mm



DOYEN

24 cm

- 55.0320** 55 x 35 mm
- 55.0321** 85 x 35 mm
- 55.0322** 115 x 35 mm
- 55.0323** 55 x 45 mm
- 55.0324** 85 x 45 mm
- 55.0325** 115 x 45 mm
- 55.0326** 55 x 60 mm
- 55.0327** 85 x 60 mm
- 55.0328** 115 x 60 mm
- 55.0329** 160 x 60 mm



SIMON

28 cm

- 55.0340** 115 x 22 mm
- 55.0342** 115 x 27 mm

Wiener Model
Vienna pattern
Modèle viennois
Modelo vienés
modello viennese



KRISTELLER

20 cm

55.0350 110 x 20 mm

55.0351 110 x 30 mm

55.0352 110 x 36 mm

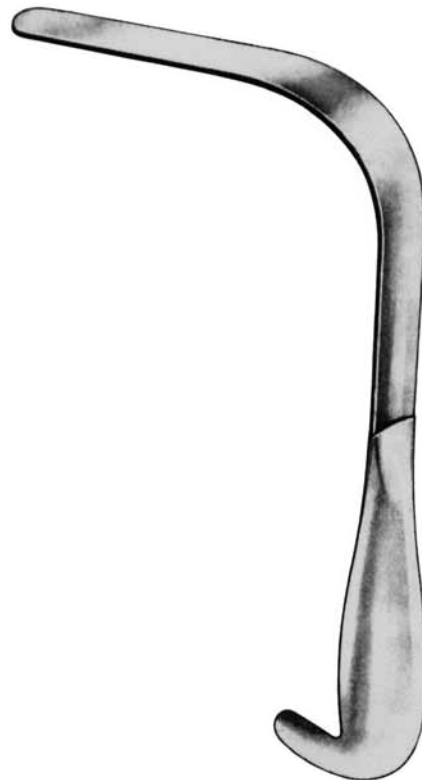

KRISTELLER

21 cm

55.0353 115 x 18 mm

55.0354 115 x 26 mm

55.0355 115 x 32 mm

Satz / set / jeu / juego / Set

55.0357 110 x 20 mm

55.0358 110 x 30 mm

55.0359 110 x 36 mm



FRIEDMANN

55.0500 10 cm



KOGAN
55.0530 24 cm



KOGAN
55.0532 24 cm

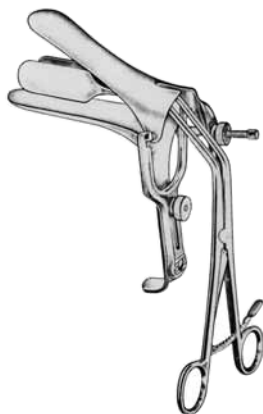

LATERAL
55.0550
22 cm





HEGAR

55.0735 Satz / set / jeu / juego / Serie 4 -17 mm

in auskochbarer Stoffrolltasche
 in boilable canvas roll
 en toile roulable, lavable à l'eau bouillant
 en bolsa de tela esterilizable para embullición
 in busta di tela sterilizzabile

HEGAR

Ø mm		Ø mm	
1	55.0701	1,5	55.0791
2	55.0702	2,5	55.0792
3	55.0703	3,5	55.0793
4	55.0704	4,5	55.0794
5	55.0705	5,5	55.0795
6	55.0706	6,5	55.0796
7	55.0707	7,5	55.0797
8	55.0708	8,5	55.0798
9	55.0709	9,5	55.0799
10	55.0710	10,5	55.0800
11	55.0711	11,5	55.0801
12	55.0712	12,5	55.0802
13	55.0713	13,5	55.0803
14	55.0714	14,5	55.0804
15	55.0715	15,5	55.0805
16	55.0716	16,5	55.0806
17	55.0717	17,5	55.0807
18	55.0718	18,5	55.0808
19	55.0719	19,5	55.0809
20	55.0720		
21	55.0721		
22	55.0722		
23	55.0723		
24	55.0724		
25	55.0725		
26	55.0726		
27	55.0727		
28	55.0728		
29	55.0729		
30	55.0730		
32	55.0731		

55.0732 Satz / set / jeu / juego / Serie 4 - 17 mm

55.0733 Satz / set / jeu / juego / Serie 1 - 26 mm



HEGAR

55.0736 Satz / set / jeu / juego / Serie 4 - 17 mm

55.0737 Satz / set / jeu / juego / Serie 1 - 26 mm

in Metalletui Nr. 55.0851
 in Metal case No. 55.0851
 en boîte métal No. 55.0851
 en caja metálica No. 55.0851
 in scatola metallica 55.0851

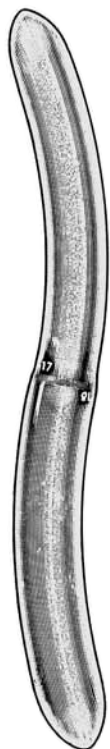

HEGAR

Ø mm	
1 / 2	55.0741
3 / 4	55.0743
5 / 6	55.0745
7 / 8	55.0747
9 / 10	55.0749
11 / 12	55.0751
13 / 14	55.0753
15 / 16	55.0755
17 / 18	55.0757
19 / 20	55.0759
21 / 22	55.0761
23 / 24	55.0763
25 / 26	55.0765

55.0772 Satz / set / jeu / juego / Serie 3 / 4 - 17 / 18 mm

55.0773 Satz / set / jeu / juego / Serie 1 / 2 - 25 / 26 mm



HEGAR

55.0775 Satz / set / jeu / juego / Serie 3 / 4 - 17 / 18 mm

in auskochbarer Stoffrolltasche
in boilable canvas roll
en toile roulable, lavable à l'eau bouillant
en bolsa de tela esterilizable para embullición
in busta di tela sterilizzabile



HEGAR

55.0776 Satz / set / jeu / juego / Serie 3 / 4 - 17 / 18 mm

55.0777 Satz / set / jeu / juego / Serie 1 / 2 - 25 / 26 mm

in Metalletui
in Metal case
en boîte métal
en caja metálica
in scatola metallica



GOODELL

55.0902 34 cm



SIMS

55.1001 32 cm

mit Zentimetereinteilung, biegsam, versilbert
graduated in cm, malleable, silver-plated
gradu  en cm, mall able, argent 
graduado in centimetros, maleable, plateado
graduato in cm, malleabile, argentato

55.1004 32 cm

mit Zentimetereinteilung, starr, versilbert
graduated in cm, rigid, silver-plated
gradu  en cm, rigide, argent 
graduado in centimetros, r gido, plateado
graduato in cm, rigido, argentato

SIMS

55.1001S 32 cm

mit Zentimetereinteilung, biegsam, 18/8 Stahl
graduated in cm, malleable, 18/8 steel
gradu  en cm, mall able, acier 18/8
graduado in centimetros, maleable, acero 18/8
graduato in cm, malleabile, acciaio 18/8

55.1004S 32 cm

mit Zentimetereinteilung, starr, 18/8 Stahl
graduated in cm, rigid, 18/8 steel
gradu  en cm, rigide, acier 18/8
graduado in centimetros, r gido, acero 18/8
graduato in cm, rigido, acciaio 18/8

MARTIN

55.1021 32 cm

biegsam/malleable
mall abl/maleable/malleabile

55.1024 32 cm

starr/rigid
rigide/rigida/rigido

VALLEIX

55.1030

27 cm



BRAUN
55.1100
28 cm

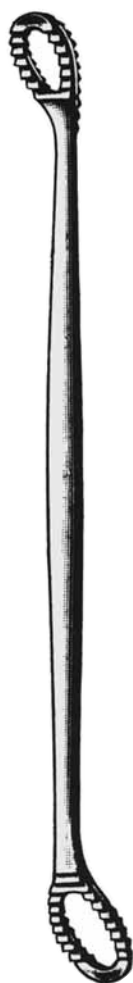

SIMS
55.1110
26 cm

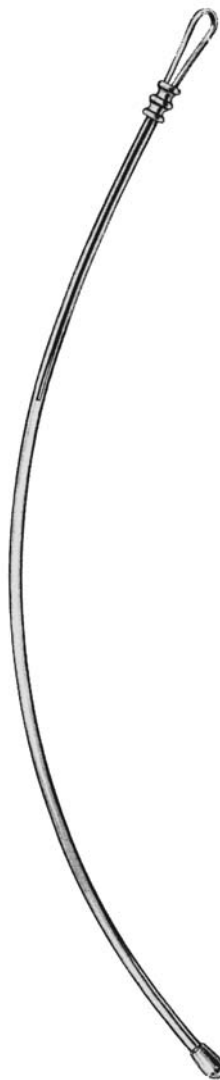

AMANN
55.1120
32 cm
Tamponadeführer
Uterine gauze packer
Conducteur porte-tampon
Conductor de tampónes
Porta garza uterino



BEACHAM
55.1200
26 cm
Amniotom
Amniotome
Amniotome
Amniotómo
Amniotomo

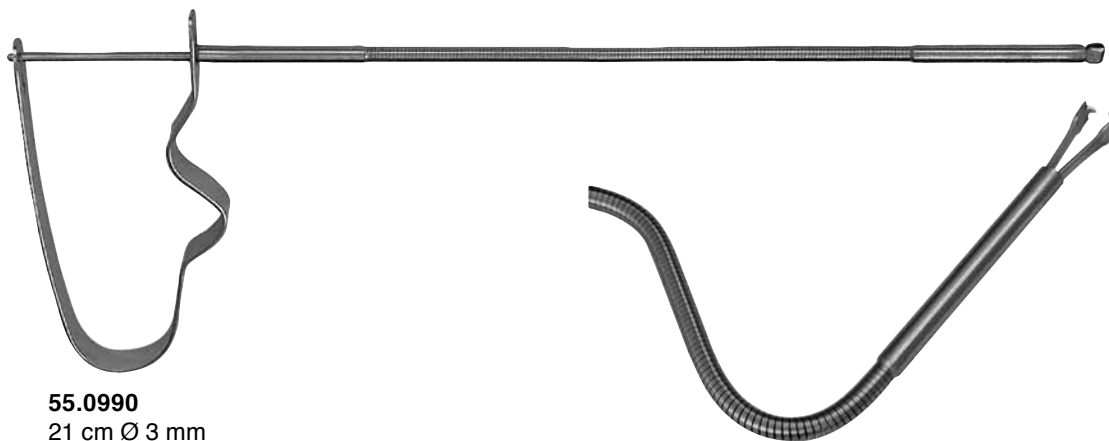

55.0990

21 cm Ø 3 mm

starr / rigid / rigide / rigido / rigido

55.0991

21 cm Ø 3 mm

biegsam / malleable / malléable / maleable / malleabile



IUP

55.1565

26 cm

IUP Haken zur Entfernung, biegsam

IUD Extractor hook, malleable

DIU Crochet pour extraction, malléable

DIU Gancho para extracción, maleable

IUD Uncino per estrazione, malleabile

RAMATHIBODI

55.1525

27,5 cm

Uterusmanipulator

Uterine Manipulator

Manipulateur utérin

Manipulador uterino

Manipulatore uterino

RAMATHIBODI

55.1526

25,5 cm

Tubus-Haken

Tubular Hook

Crochet tubulaire

Gancho tubular

Uncino tubular



BARRETT
55.0930
18 cm

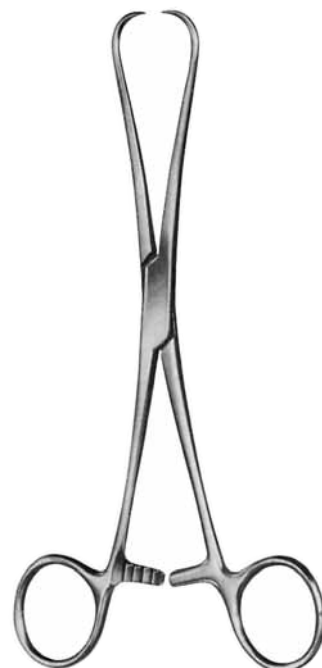

STAUDE-MOORE
55.0932
17 cm



BRAUN
55.0934
25 cm

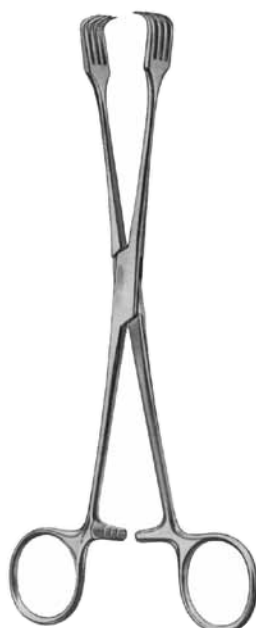

BRAUN
55.0933
16 cm



CZERNY
55.0936
21 cm



ADAIR
55.0937 16 cm
55.0938 19 cm



SCHROEDER
55.0940 25 cm

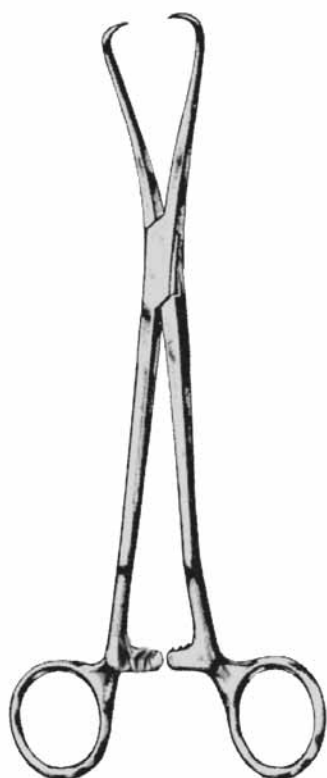

JARCHO
55.0945 20 cm



POZZI
55.0942 25cm
stumpf / blunt / mousse / roma / smussa
55.0944 25cm
spitz / sharp / pointu / agudo / acuto



DUPLAY
55.0947
28 cm



HULKA
55.0948
29 cm

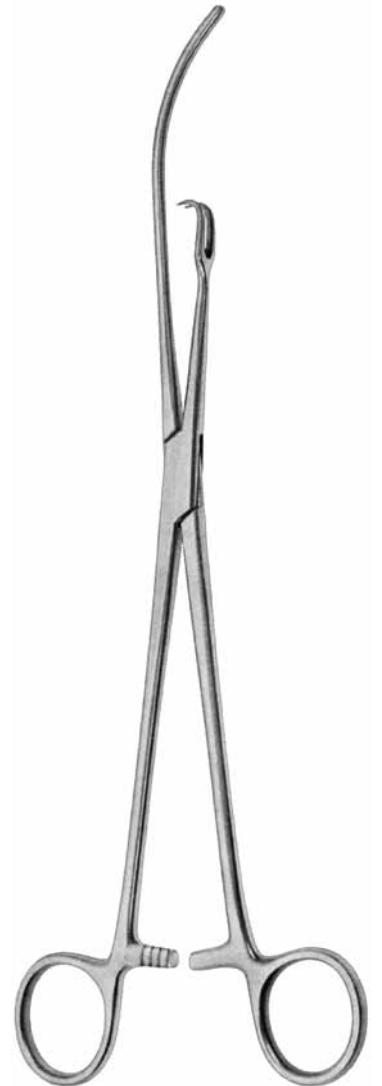

HULKA-KENWICK
55.0949
29 cm



SKENE
55.0951
24 cm

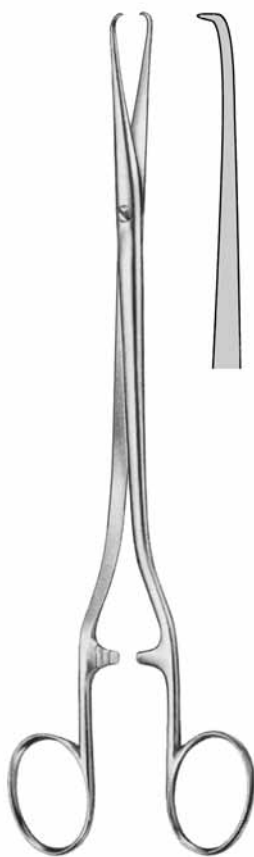

TIEMANN
55.0956
22 cm

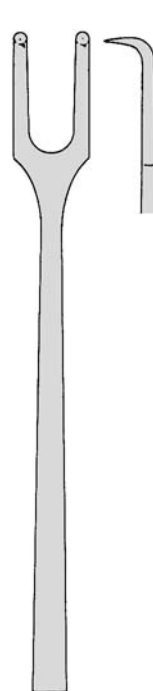

55.0962
2 x 2

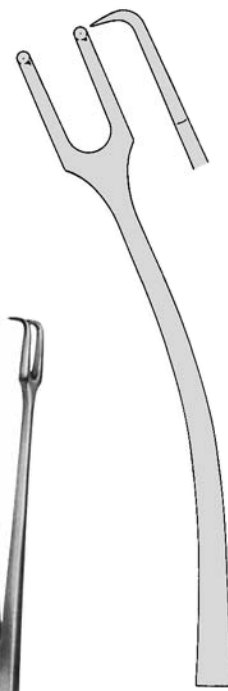

55.0963
2 x 2



SCHROEDER
24 cm

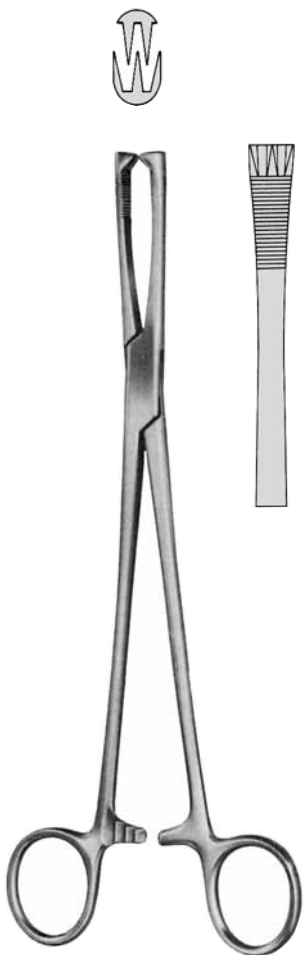

HENROTIN
55.0965
21 cm 2 x 3



PRATT (Billroth)
55.0966
26,5 cm

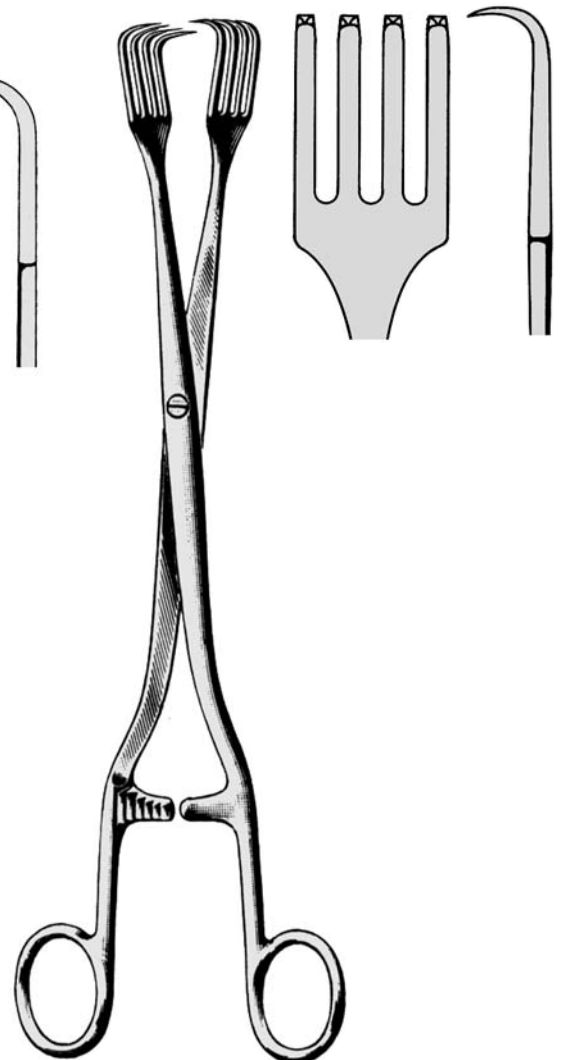

PRATT
55.0968
28 cm



JACOBS
55.0970 21 cm



TEALE
55.0973 18 cm 3 x 4
55.0975 23 cm 3 x 4



KÜSTNER
55.0977 25 cm 2 x 3

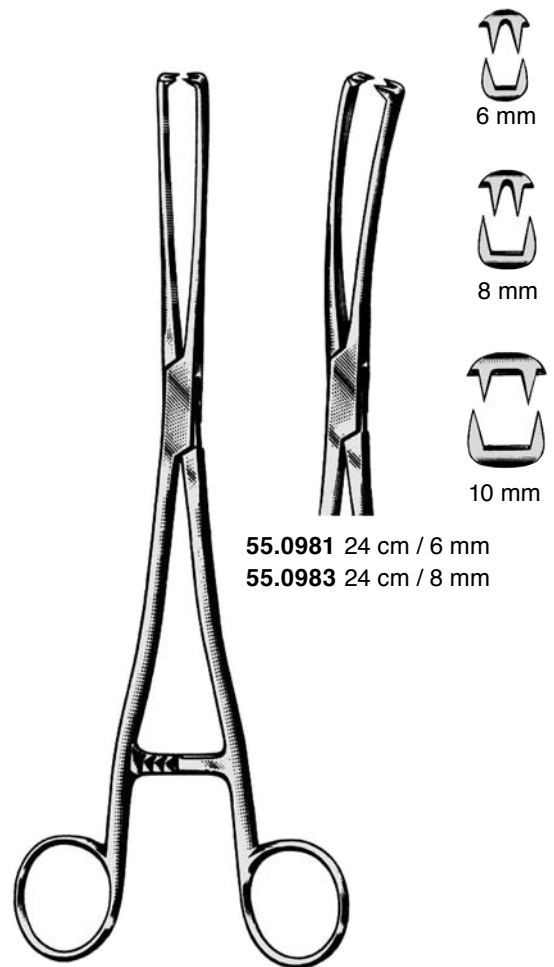

55.0981 24 cm / 6 mm
55.0983 24 cm / 8 mm

MUSEUX
55.0980 24 cm / 6 mm
55.0982 24 cm / 8 mm
55.0984 24 cm / 10 mm



SOMER
55.1500
23 cm



COLLIN
55.1510
25 cm

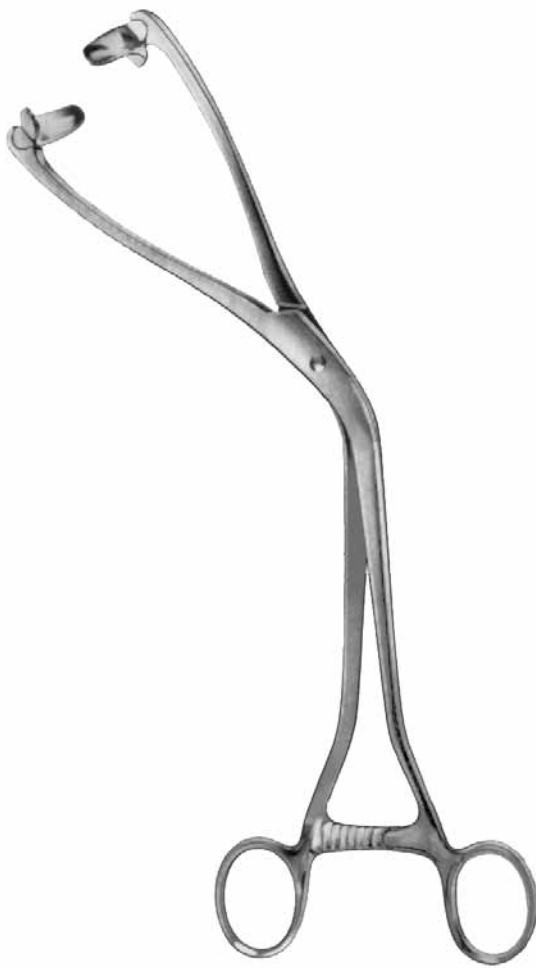

COLLIN
55.1511
25 cm



DARTIGUES
55.1520
27 cm



HEYWOOD-SMITH

56.0880 21 cm

56.0882 25 cm

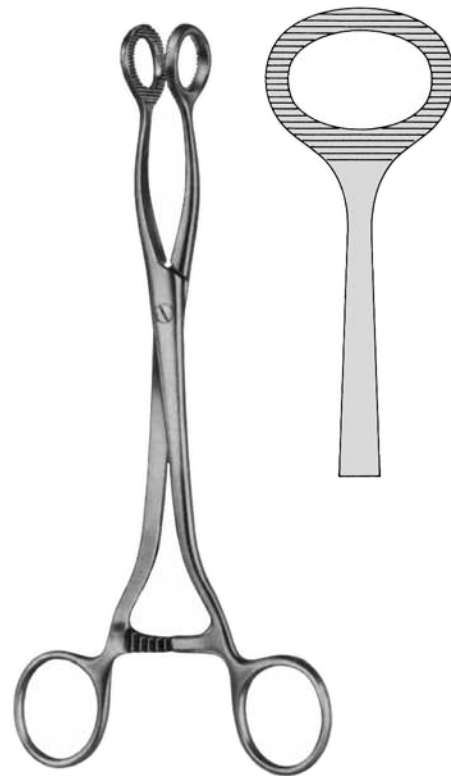

DOYEN

56.0890 20 cm



NOTO
56.0896 27 cm



BUMM
56.0898 28 cm



EMMET
22 cm



55.1551
1



55.1552
2



55.1553
3



55.1554
4



55.1555
5

Fistelhaken
Fistula hooks
Crochets pour fistules
Ganchitos para fistulas
Uncini per fistole



SIMON
55.1561
22 cm



SIMON
55.1562
22 cm



DOYEN
55.1600
17 cm Ø 26 mm

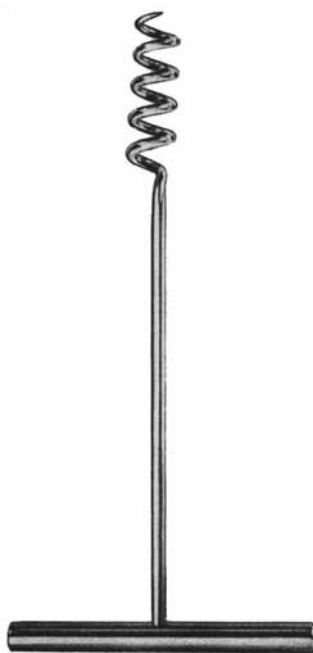

DOYEN
55.1602
17 cm Ø 20 mm

Myomheber
Myoma Screws
Tracteurs pour fibromes
Tirabuzones para fibroma
Tiramiomi



SEGOND
55.1610
27 cm

Myommesser
Myoma Knife
Couteau pour fibromes
Cuchillo para fibroma
Bisturi per fibromi



WERTHEIM
 15.2125
 24 cm 1x2

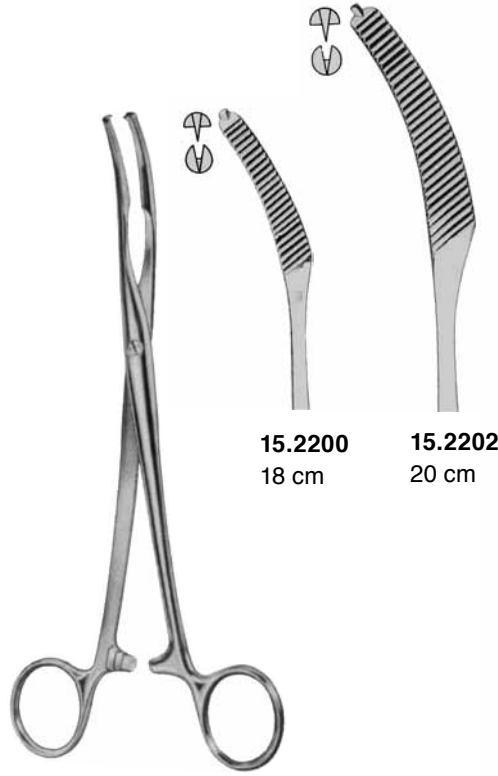

15.2200
 18 cm

15.2202
 20 cm



15.2209
 20 cm

15.2211
 20 cm

MIKULICZ

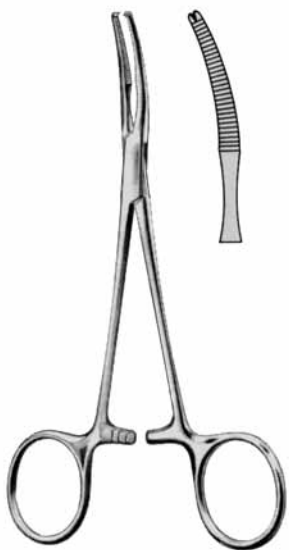

MIKULICZ-BABY
 15.2215 14 cm

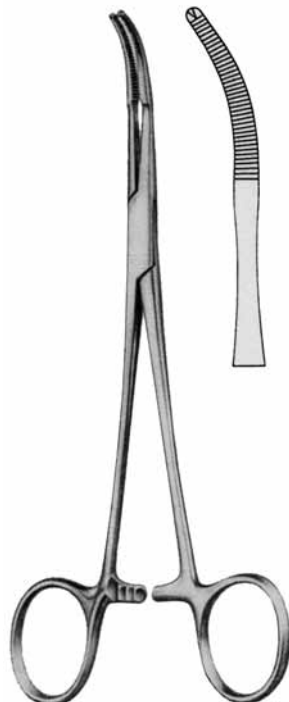

MIKULICZ
 15.2216 18 cm

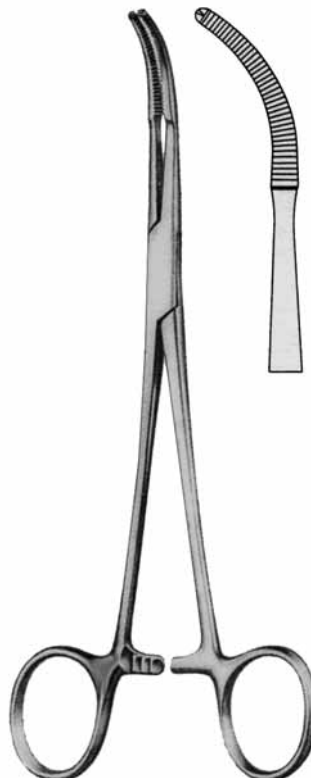

MIKULICZ
 15.2217 20 cm

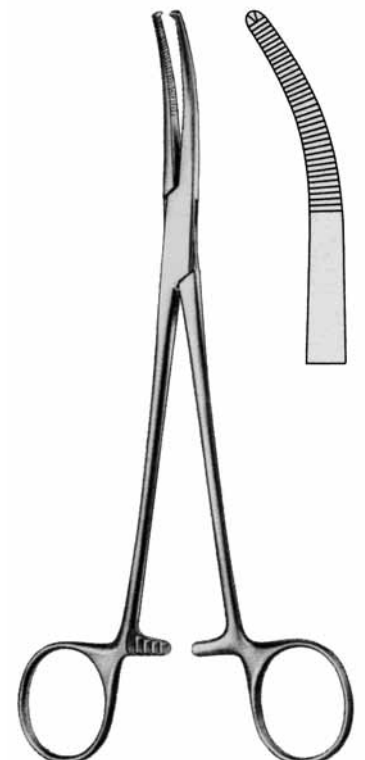

MIKULICZ
 15.2218 21 cm



FAURE
20 cm



15.2221



15.2223



FAURE
15.2225 25 cm

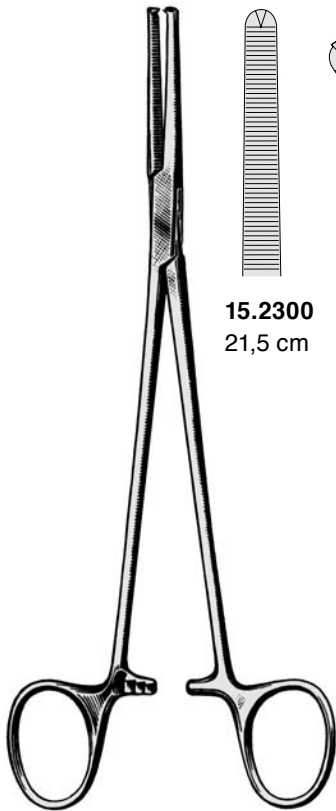

15.2300
21,5 cm

15.2301
21,5 cm

PHANEUF

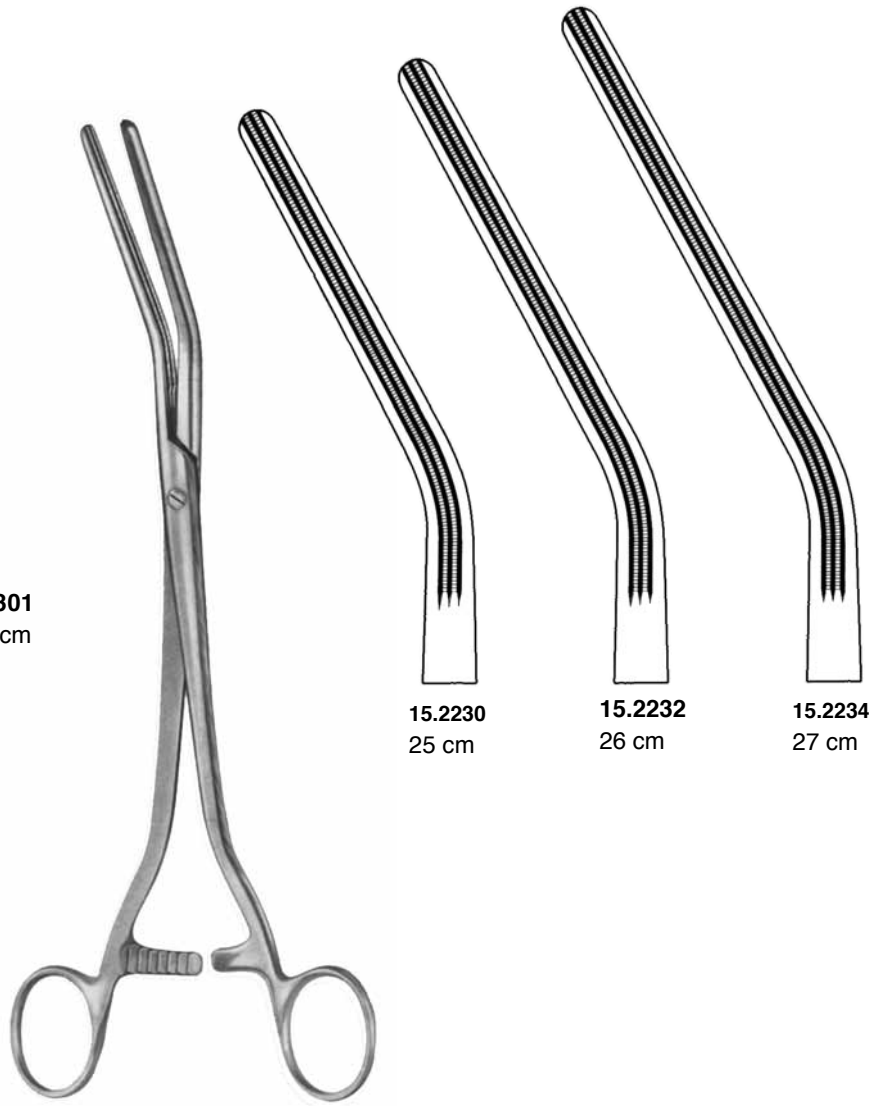

15.2230
25 cm

15.2232
26 cm

15.2234
27 cm

DICK

Druckklemmen
Pressure Clamps
Pincés à pression
Pinzas de presión
Pinze de pressione



HEANEY-KANTOR

15.2311 20 cm

15.2313 23 cm



HEANEY-REZEK

15.2314 23 cm

15.2316 21 cm



HEANEY

15.2315 20 cm

15.2317 23 cm

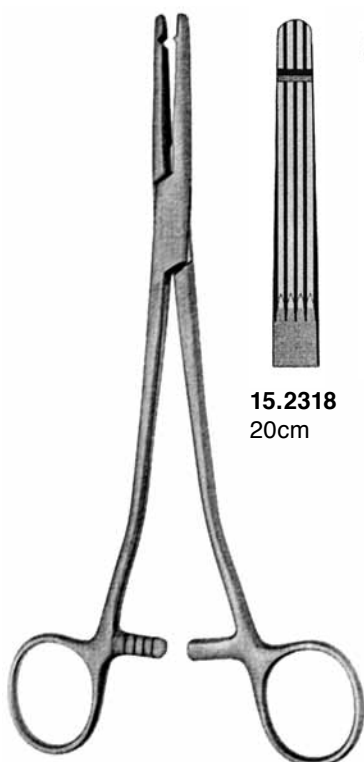

HEANEY-BALLENTINE

15.2318
20cm



15.2319
20cm

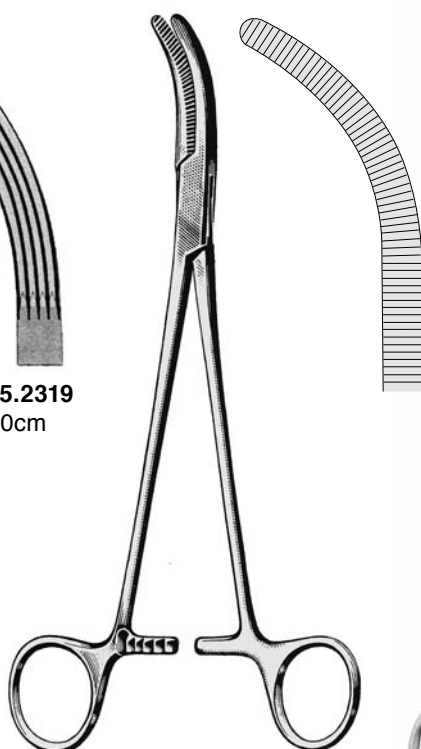

WERTHEIM

15.2321 25 cm

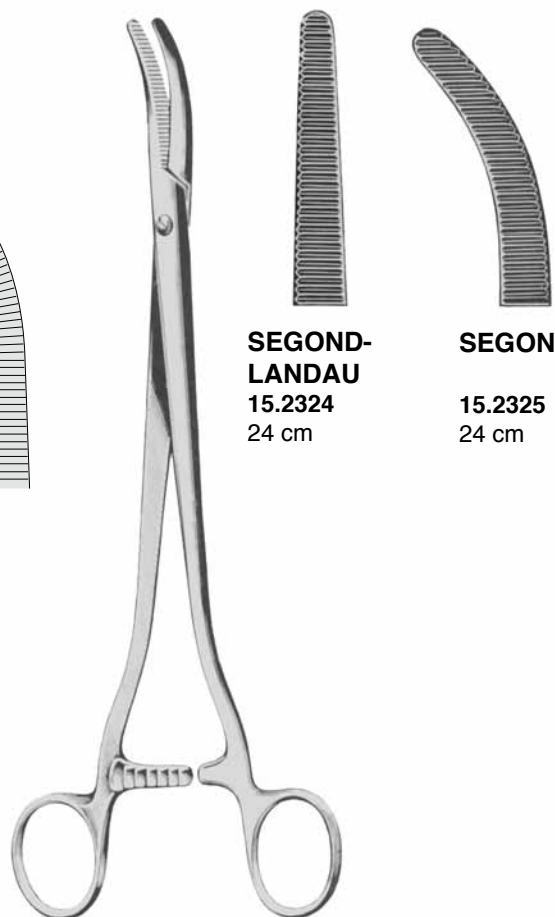

**SECOND-
LANDAU**

15.2324
24 cm

SECOND

15.2325
24 cm

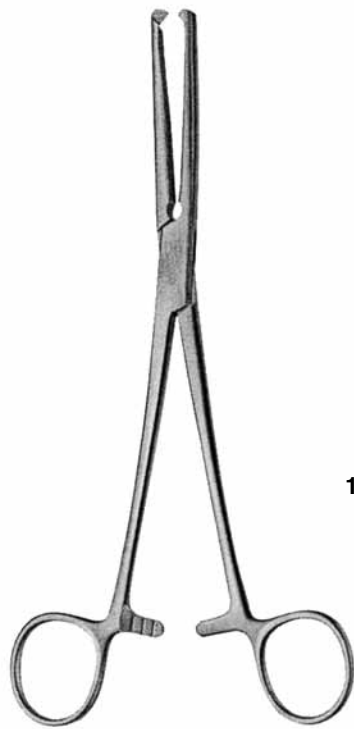

GWILLIAM
20 cm



15.2330



15.2331



BERKELEY-BONNEY
15.2337
20 cm

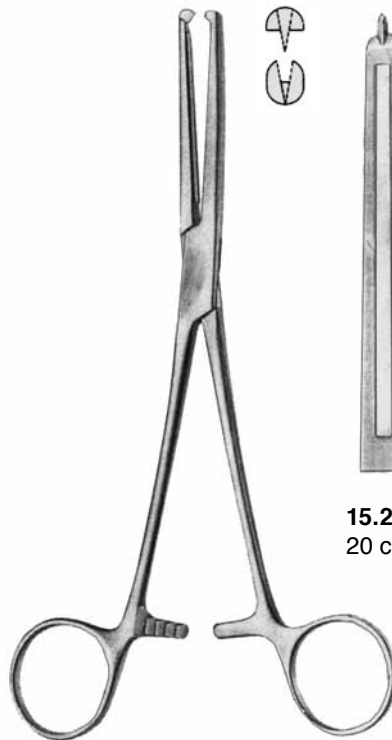

MAINGOT



15.2332
20 cm 1x2



15.2333
20 cm 1x2



15.2335
25 cm 1x2



WERTHEIM-CULLEN
15.2340 21,5 cm

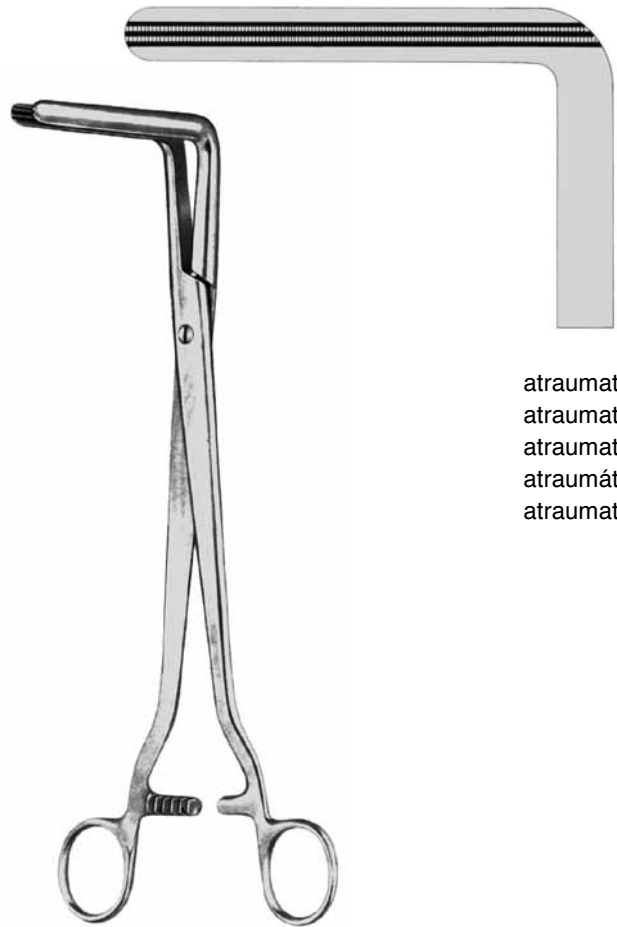

WERTHEIM-ATRAUMA
15.2344 21 cm

atraumatisch
atraumatic
atraumatique
atraumática
atraumatiche



WERTHEIM



15.2345
22 cm
1x2



15.2347
22 cm
1x2

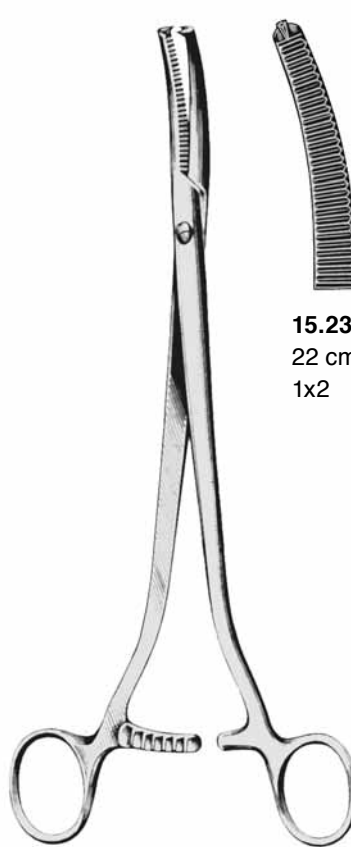

WERTHEIM



15.2348
22 cm
1x2



15.2349
22 cm
1x2

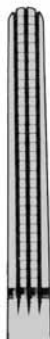

15.2360
22 cm



15.2361
22 cm



15.2362
21 cm

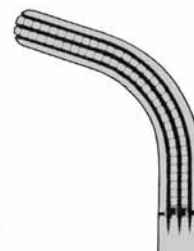

15.2363
20 cm



WERTHEIM-DEBAKEY

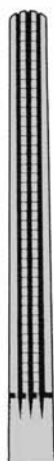

15.2365
25 cm



15.2366
25 cm



15.2367
25 cm

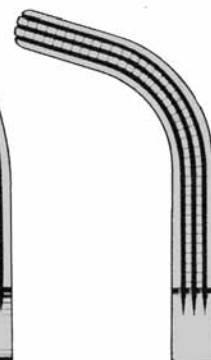

15.2368
24 cm



Z-HYSTEREKTOMY



- 15.2380 21 cm
- 15.2384 24 cm
- 15.2388 30 cm
- 15.2392 35 cm



- 15.2381 21 cm
- 15.2385 24 cm
- 15.2389 30 cm
- 15.2393 35 cm



- 15.2382 21 cm
- 15.2386 24 cm
- 15.2390 30 cm
- 15.2394 35 cm



- 15.2383 21 cm
- 15.2387 24 cm
- 15.2391 30 cm
- 15.2395 35 cm



THOMS-GAYLOR
55.1802 24 cm

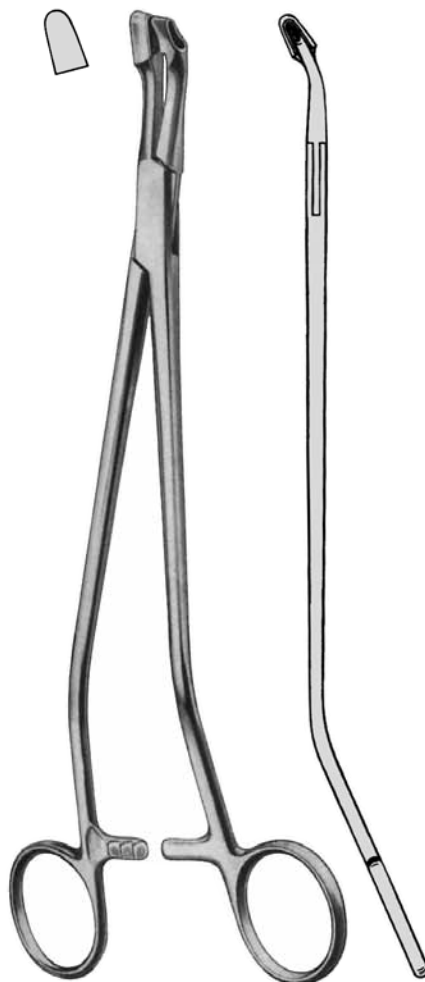

VAN DOREN
55.1803 25 cm



SCHUMACHER-VAN DOREN
55.1805 24 cm



4x8 mm



SCHUBERT
55.1820 21 cm
55.1822 28 cm



4x8 mm



SCHUBERT
55.1825 26 cm



5x9,5 mm



FAURE
55.1835 21 cm

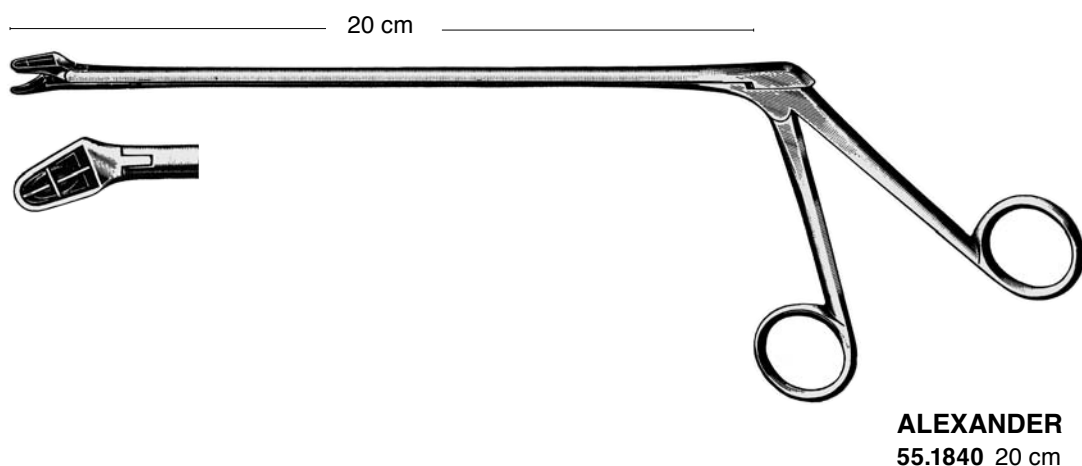
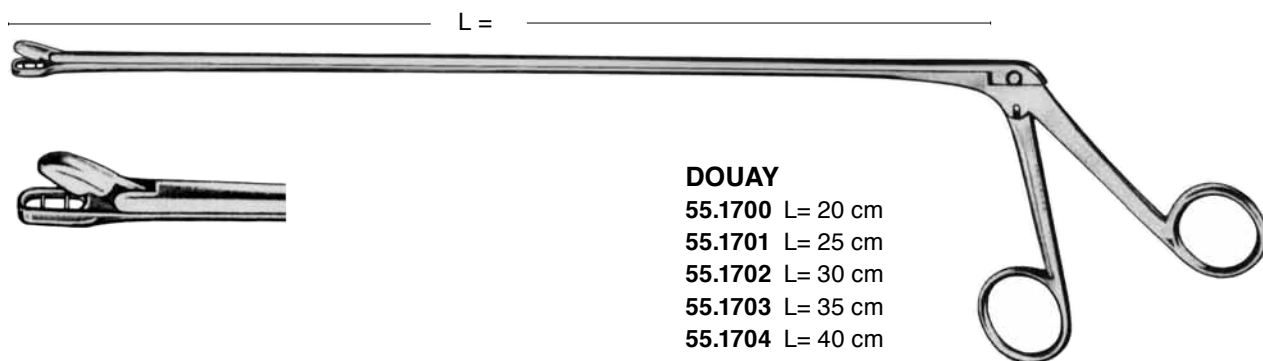

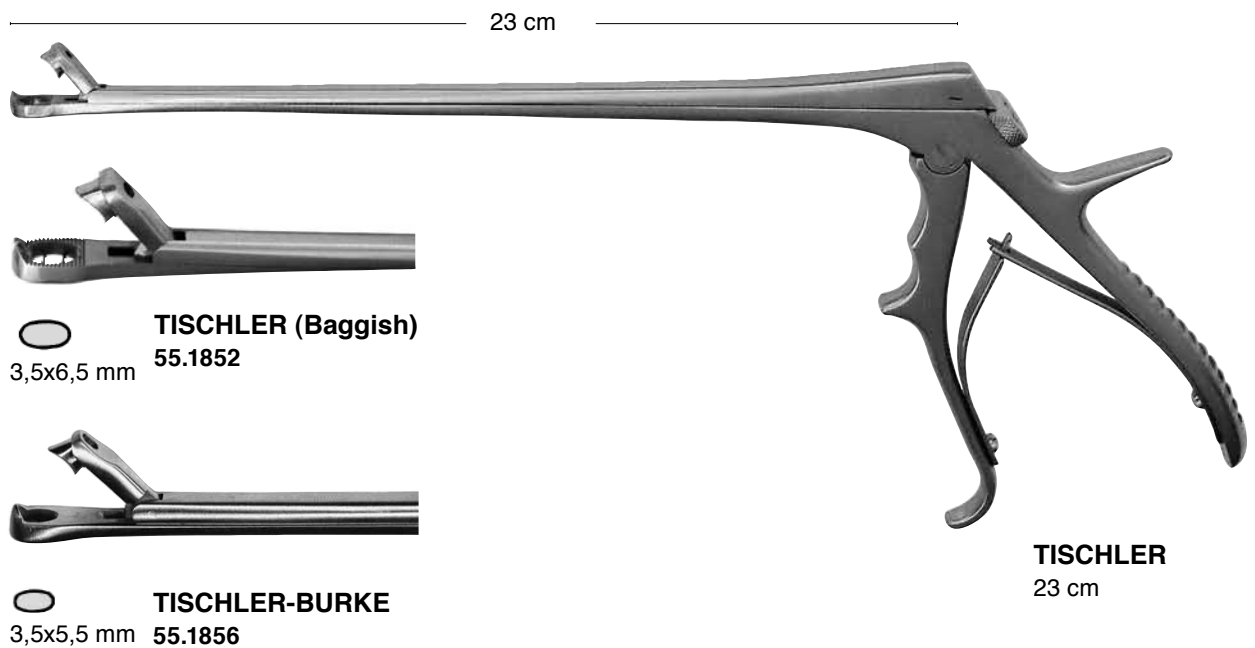
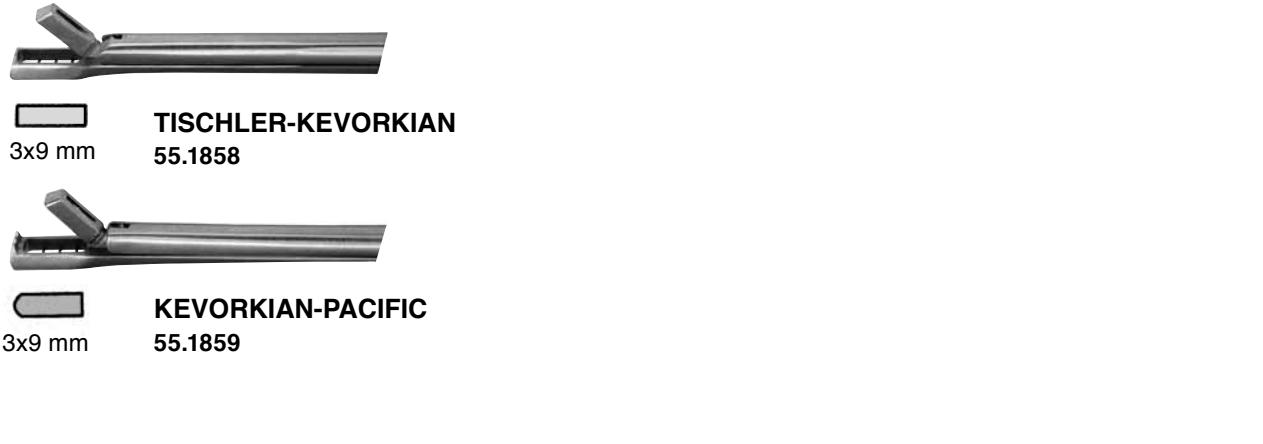
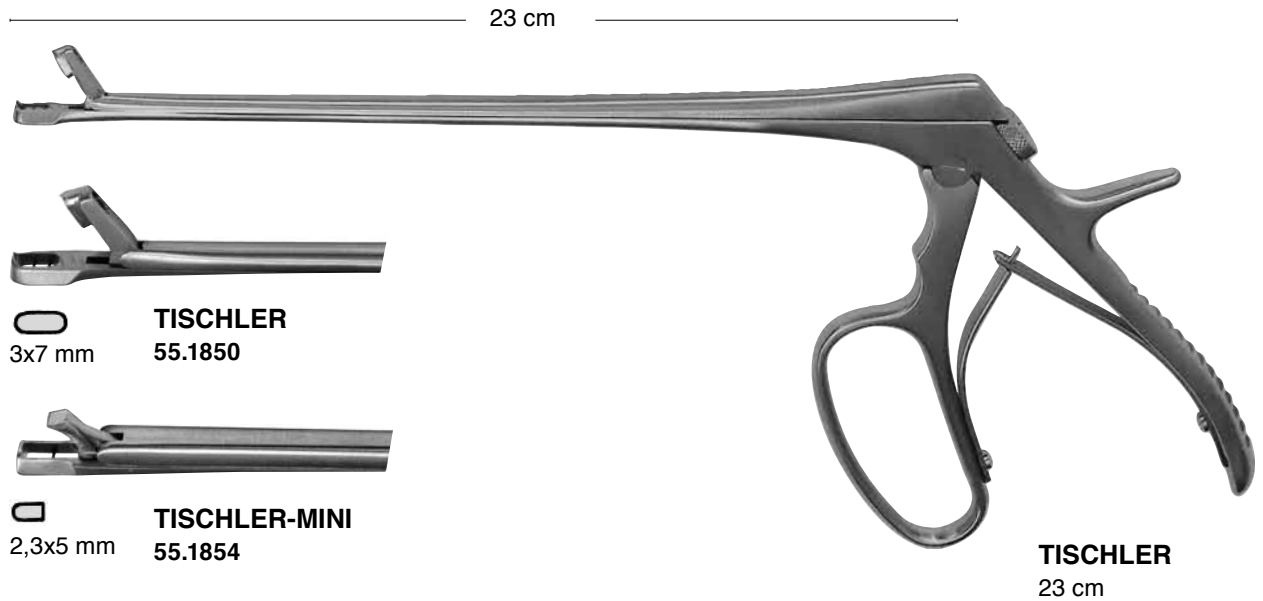

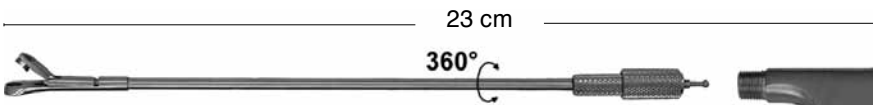

23 cm
360°

55.1898
 auch lieferbar mit Ringgriff (bitte Einzelteile getrennt bestellen)
 also available with ringhandle (please order components seperately)
 aussi disponible avec manche à anneaux (merci de commander les pièces séparément)
 tambien disponible con mango de anilla (por favor pedir por separado los componentes)
 disponibile anche con manico ad anello (si prega di ordinare gli componenti separatamente)

TOWNSEND 55.1899
 Griff alleine
 Handle only
 Manche seul
 Mango suelto
 Manico solo

gerade / straight
 droits / derecha / retto

aufgebogen / curved up / courbe vers le haut / curva arriba / curvo in alto

abwärts gebogen / curved down / courbe vers le bas / curva abajo / curva in basso

3x7 mm



TOWNSEND-TISCHLER 55.1860 360°
 komplett / complete
 complet / completo / completo

55.1880
 Aufsatz alleine / tip only
 embout seul / punta suelto / Punta sola

3x7 mm



TOWNSEND-TISCHLER 55.1861 360°
 komplett / complete
 complet / completo / completo

55.1881
 Aufsatz alleine / tip only
 embout seul / punta suelto / Punta sola

3x7 mm



TOWNSEND-TISCHLER 55.1863 360°
 komplett / complete
 complet / completo / completo

55.1883
 Aufsatz alleine / tip only
 embout seul / punta suelto / Punta sola

2,3x5 mm



TOWNSEND-MINI 55.1866 360°
 komplett / complete
 complet / completo / completo

55.1886
 Aufsatz alleine / tip only
 embout seul / punta suelto / Punta sola

2,3x5 mm



TOWNSEND-MINI 55.1867 360°
 komplett / complete
 complet / completo / completo

55.1887
 Aufsatz alleine / tip only
 embout seul / punta suelto / Punta sola

2,3x5 mm



TOWNSEND-MINI 55.1869 360°
 komplett / complete
 complet / completo / completo

55.1889
 Aufsatz alleine / tip only
 embout seul / punta suelto / Punta sola

3x5,5 mm



TOWNSEND-BURKE 55.1870 360°
 komplett / complete
 complet / completo / completo

55.1890
 Aufsatz alleine / tip only
 embout seul / punta suelto / Punta sola

3x9 mm



TOWNSEND-KEVORKIAN 55.1872 360°
 komplett / complete
 complet / completo / completo

55.1892
 Aufsatz alleine / tip only
 embout seul / punta suelto / Punta sola

3x5,5 mm



TOWNSEND-KRAUSE 55.1874 360°
 komplett / complete
 complet / completo / completo

55.1894
 Aufsatz alleine / tip only
 embout seul / punta suelto / Punta sola

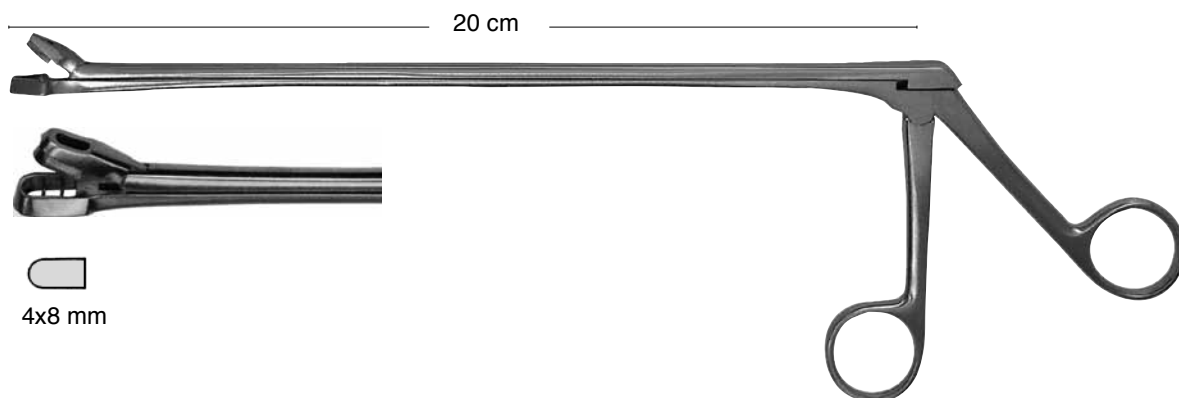

EPPENDORF
55.1900 20 cm

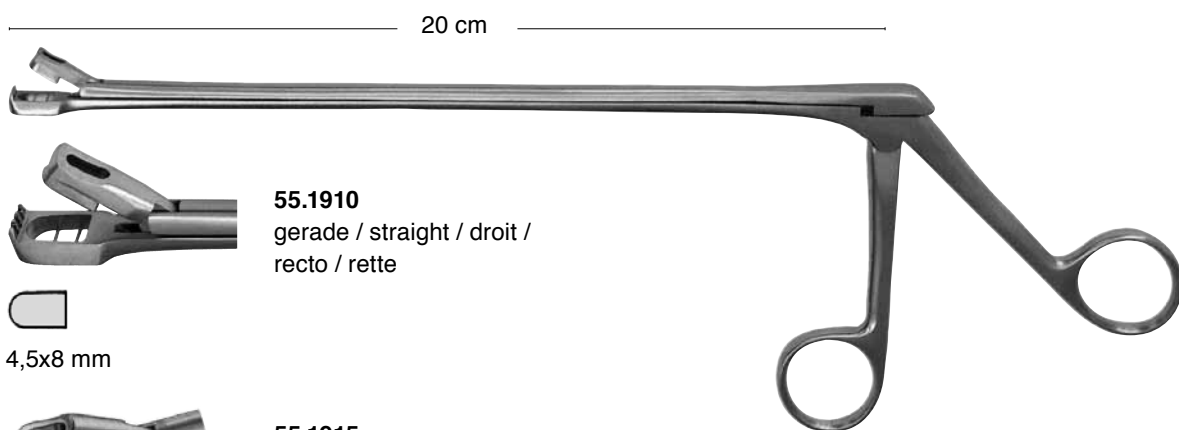

WITNER
20 cm

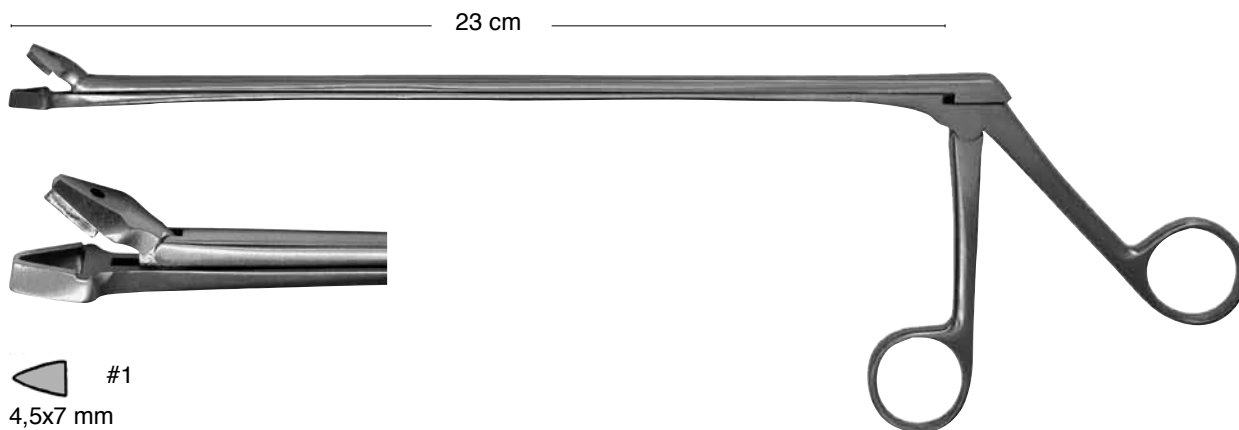

SCHUMACHER
55.1920 23 cm #1
55.1922 23 cm #2

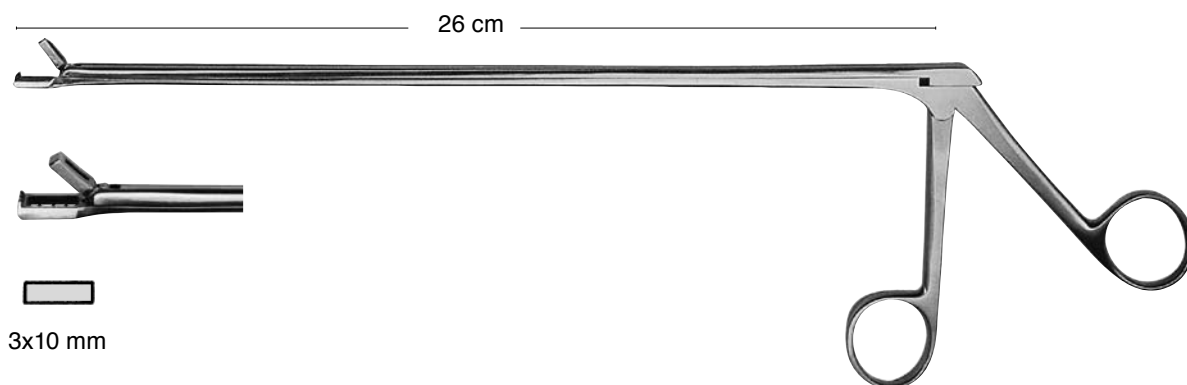

KEVORKIAN
55.1962 26 cm

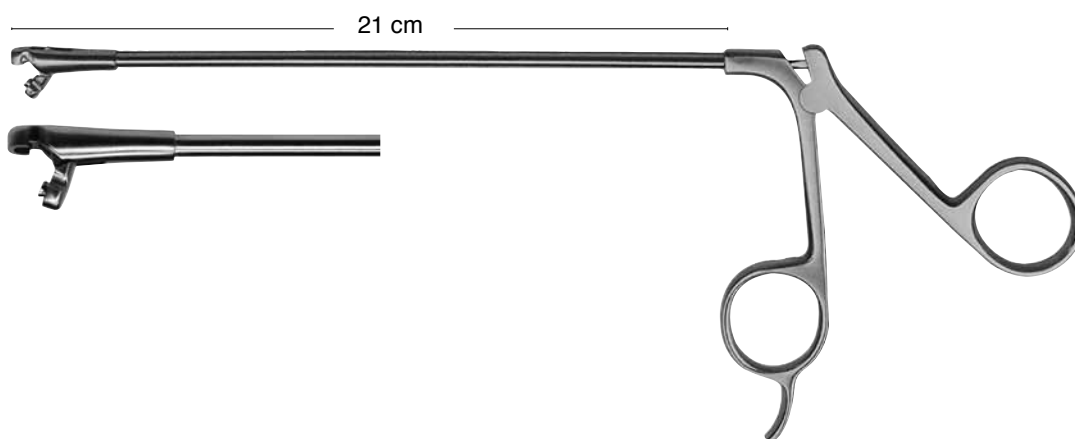

BERGER
55.1973

○ 21 cm / Ø 3 mm

55.1975

○ 21 cm / Ø 5 mm

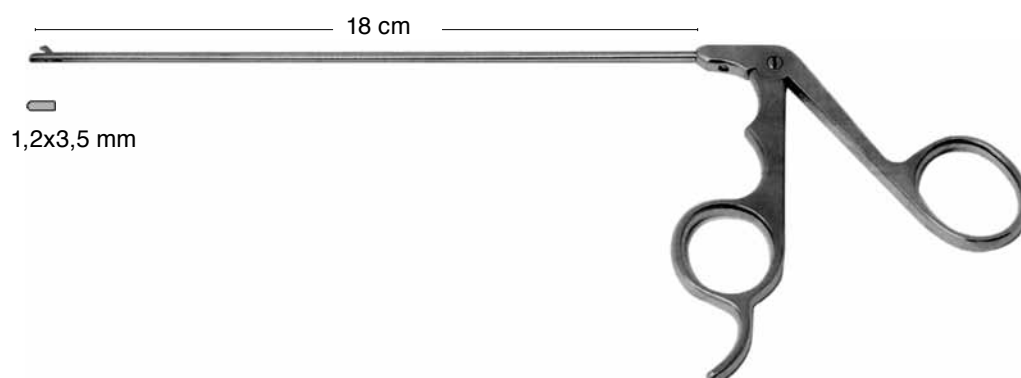

MICRO
55.1980 18 cm



55.2240



55.2242



55.2244

KEVORKIAN
30 cm



TOWNSEND
55.2246
30 cm



ROTOCURETTE
55.2250
30 cm



55.2254
Ø 4 mm



55.2255
Ø 5 mm







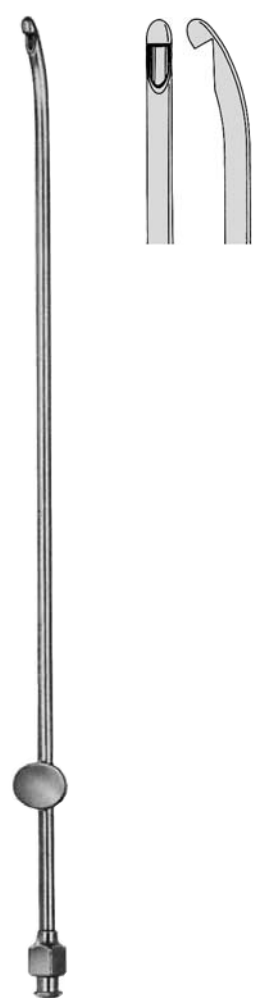







MUENCHEN
27 cm



NOVAK
23 cm
55.2201 Ø 1 mm
55.2202 Ø 2 mm
55.2203 Ø 3 mm
55.2204 Ø 4 mm



RANDALL
23 cm
55.2210 Ø 4 mm

	 55.2001 # 1-7 mm		 55.2181 #1 10x7 mm
	 55.2002 # 2-8 mm		 55.2182 #2 12x8 mm
	 55.2003 # 3-10 mm		 55.2183 #3 13x10 mm
	 55.2004 # 4-11 mm		 55.2184 #4 16x11 mm
	 55.2005 # 5-12 mm		 55.2185 #5 16x13 mm
	 55.2006 # 6-15 mm		 55.2186 #6 20x14 mm
SCHROEDER 30 cm	BLAKE 55.2010 27 cm	SIMON 24 cm	

stumpf
 blunt
 mousse
 romo
 smusso

scharf
 sharp
 tranchante
 cortante
 tagliente

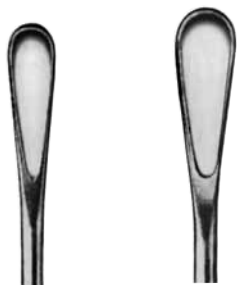

55.2190
6 mm

55.2191
8 mm



GOURDET
28 cm



55.2192
10 mm



55.2193
12 mm



55.2194
14 mm



THOMAS
28 cm



55.2221
#1 Ø 10 mm



55.2224
#4 Ø 13 mm



55.2222
#2 Ø 11 mm



55.2225
#5 Ø 14 mm



55.2223
#3 Ø 12 mm



55.2226
#6 Ø 15 mm

biegsam, stumpf
 malleable, blunt
 malléable, mousse
 maleable, romo
 malleabile, smusso

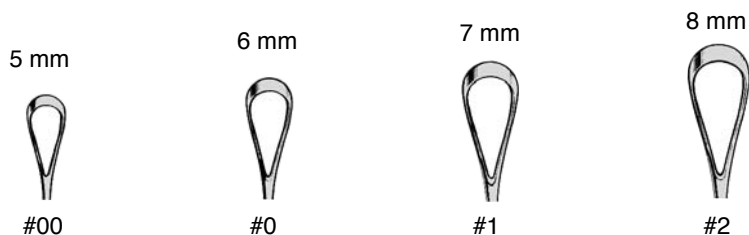

fest, scharf / rigid, sharp / rigide, tranchante / rigida, cortante / rigido, tagliente	55.2019	55.2020	55.2021	55.2022
fest, stumpf / rigid, blunt / rigide, mousse / rigida, roma / rigido, smusso	55.2039	55.2040	55.2041	55.2042
biegsam, scharf / malleable, sharp / malléable, tranchante / maleable, cortante / malleabile, tagliente	55.2059	55.2060	55.2061	55.2062
biegsam, stumpf / malleable, blunt / malléable, mousse / maleable, roma / malleabile, smusso	55.2079	55.2080	55.2081	55.2082

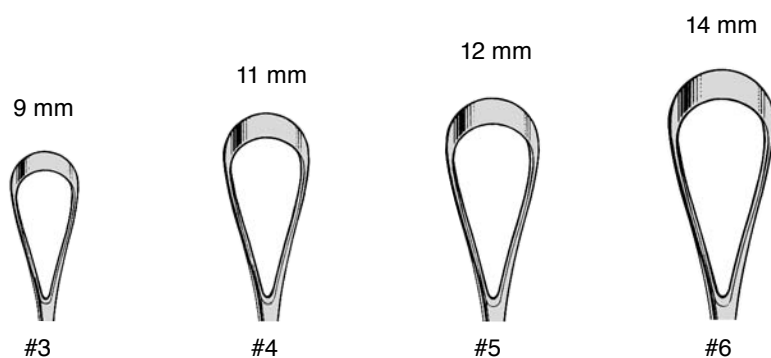

fest, scharf / rigid, sharp / rigide, tranchante / rigida, cortante / rigido, tagliente	55.2023	55.2024	55.2025	55.2026
fest, stumpf / rigid, blunt / rigide, mousse / rigida, roma / rigido, smusso	55.2043	55.2044	55.2045	55.2046
biegsam, scharf / malleable, sharp / malléable, tranchante / maleable, cortante / malleabile, tagliente	55.2063	55.2064	55.2065	55.2066
biegsam, stumpf / malleable, blunt / malléable, mousse / maleable, roma / malleabile, smusso	55.2083	55.2084	55.2085	55.2086

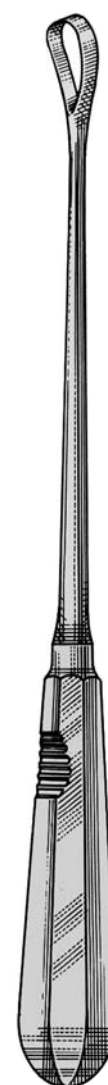

SIMS
29 cm

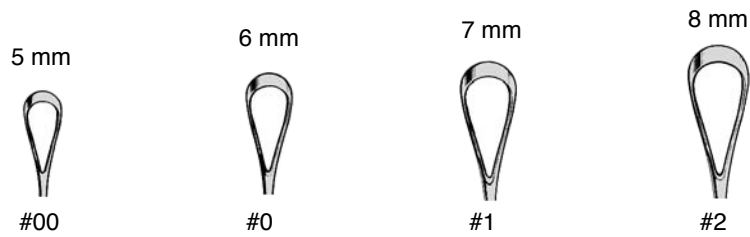

fest, scharf / rigid, sharp rigide, tranchante / rigida, cortante / rigido, tagliente	55.2109	55.2110	55.2111	55.2112
fest, stumpf / rigid, blunt rigide, mousse / rigida, roma / rigido, smusso	55.2129	55.2130	55.2131	55.2132
biegsam, scharf / malleable, sharp / malléable, tranchante / maleable, cortante / malleabile, tagliente	55.2139	55.2140	55.2141	55.2142
biegsam, stumpf / malleable, blunt / malléable, mousse / maleable, roma / malleabile, smusso	55.2149	55.2150	55.2151	55.2152

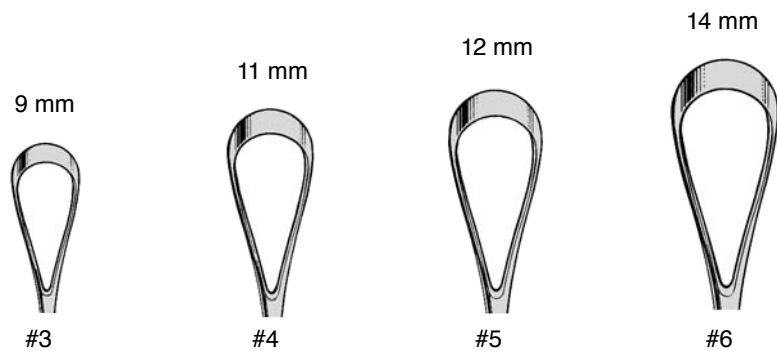

fest, scharf / rigid, sharp rigide, tranchante / rigida, cortante / rigido, tagliente	55.2113	55.2114	55.2115	55.2116
fest, stumpf / rigid, blunt rigide, mousse / rigida, roma / rigido, smusso	55.2133	55.2134	55.2135	55.2136
biegsam, scharf / malleable, sharp / malléable, tranchante / maleable, cortante / malleabile, tagliente	55.2143	55.2144	55.2145	55.2146
biegsam, stumpf / malleable, blunt / malléable, mousse / maleable, roma / malleabile, smusso	55.2153	55.2154	55.2155	55.2156

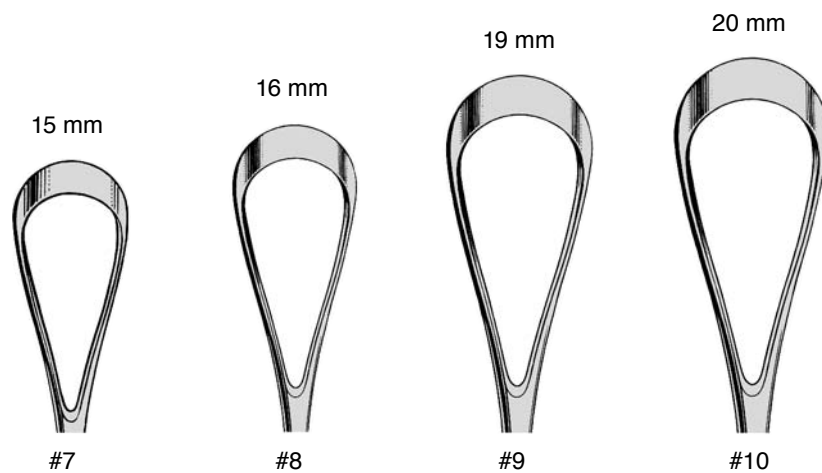

fest, scharf / rigid, sharp rigide, tranchante / rigida, cortante / rigido, tagliente	55.2117	55.2118	55.2119	55.2120
fest, stumpf / rigid, blunt rigide, mousse / rigida, roma / rigido, smusso	55.2137	55.2138	55.2127	55.2128
biegsam, scharf / malleable, sharp / malléable, tranchante / maleable, cortante / malleabile, tagliente	55.2147	55.2148		
biegsam, stumpf / malleable, blunt / malléable, mousse / maleable, roma / malleabile, smusso	55.2157	55.2158	55.2159	55.2160



RECAMIER
31 cm

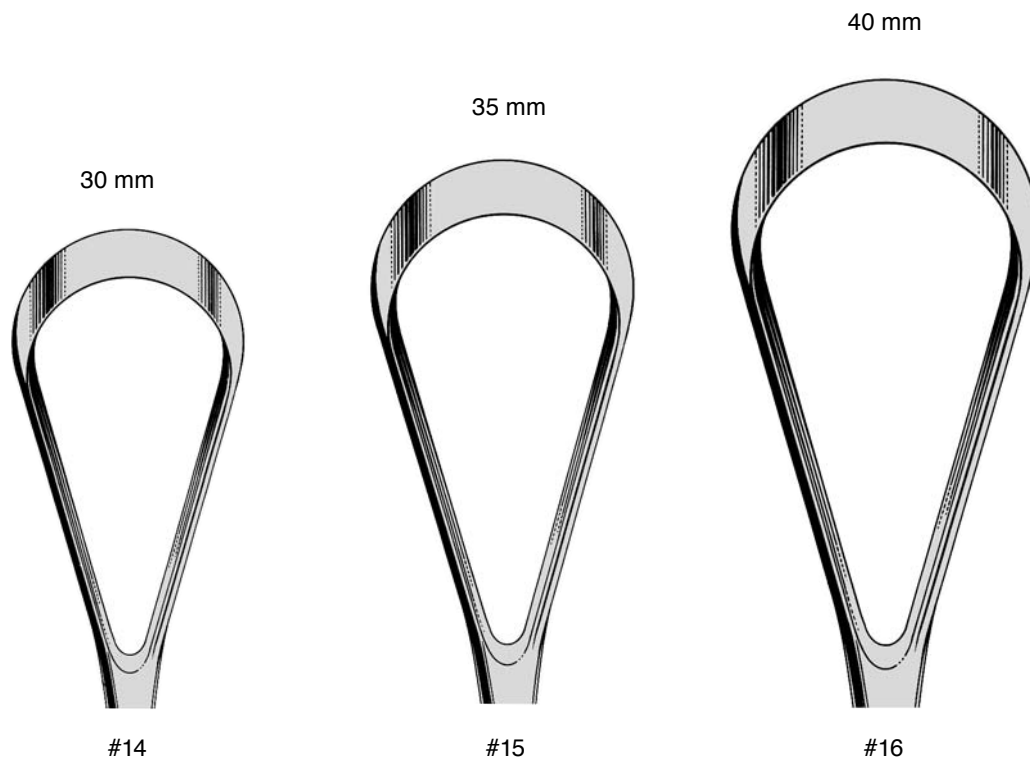

biegsam, scharf
 malleable, sharp
 malléable, tranchante
 maleable, cortante
 malleabile, tagliente

55.2171

55.2172

55.2173

biegsam, stumpf
 malleable, blunt
 malléable, mousse
 maleable, roma
 malleabile, smusso

55.2174

55.2175

55.2176



BUMM
 31 cm



35 mm



40 mm

fest, stumpf
rigid, blunt
rigide, mousse
rigida, roma
rigido, smusso

55.2178

55.2179

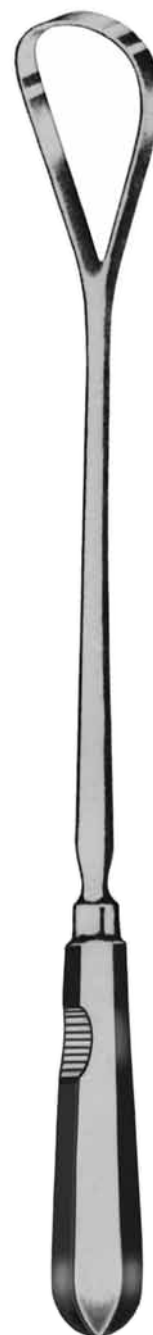

BUMM
36 cm



55.2260
28 cm / Ø 4 mm



55.2261
28 cm / Ø 6 mm



55.2262
28 cm / Ø 8 mm



55.2263
28 cm / Ø 10 mm



55.2264
28 cm / Ø 12 mm

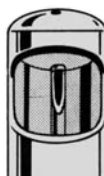

55.2265
28 cm / Ø 14 mm



55.2269
Schlauch-Verbindungsstück
Hose connector
Raccord coudé
Conector inoxidable
Racordo per tubi d'aspirazione

Salpingograph zur Sterilitätsdiagnose
Salpingograph for hystero-salpingography
Salpingographe pour hystero-salpingographie
Salpingógrafo para histero-salpingografía
Salpingografo per la diagnosi della sterilita

SCHULTZE

55.2290

Salpingograph komplett in Holzetui bestehend aus:

- 55.2291 Druck-Manometer mit Leuchtskala
- 55.2292 Zwischenstück
- 55.2293 Tubenkatheter m. Hahn
- 55.2294 Uterusverschlußkegel, klein
- 55.2295 Uterusverschlußkegel, mittel
- 55.2296 Uterusverschlußkegel, gross
- 55.2297 Rekordspritze 10 ml LL

55.2290

Salpingograph complete in wooden case consisting of:

- 55.2291 Manometer with luminescent scale
- 55.2292 Connecting piece
- 55.2293 Tubal Catheter
- 55.2294 Uterine occlusion cone, small
- 55.2295 Uterine occlusion cone, meduim
- 55.2296 Uterine occlusion cone, large
- 55.2297 Record Syringe 10 ccm, LL

55.2290

Salpingographe, complet en boîte bois, comprenant:

- 55.2291 Manomètre à cadran lumineux
- 55.2292 Pièce intermédiaire
- 55.2293 Sonde pour trombes
- 55.2294 Cône-obturateur utérin, petit
- 55.2295 Cône-obturateur utérin, moyen
- 55.2296 Cône-obturateur utérin, grand
- 55.2297 Seringue Record 10 ccm, LL

55.2290

Salpingógrafo completo en estuche de madera, compuesto de:

- 55.2291 Manómetro con escala luminosa
- 55.2292 Pieza intermedia
- 55.2293 Sonda para trompas con llave
- 55.2294 Cono uterino, pequeno
- 55.2295 Cono uterino, mediano
- 55.2296 Cono uterino grande
- 55.2297 Jeringa Record 10 cc LL

55.2290

Salpingografo completo in astuccio di legno, composta da:

- 55.2291 Manometro con scala luminosa
- 55.2292 Raccordo
- 55.2293 Catetere tubarico
- 55.2294 Cono-otturatore dell'utero piccolo
- 55.2295 Cono-otturatore dell'utero medio
- 55.2296 Cono-otturatore dell'utero grande
- 55.2297 Siringa Record 10 cc LL

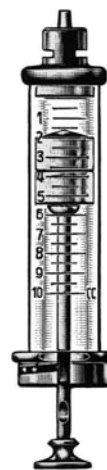

55.2297



55.2294



55.2295



55.2296

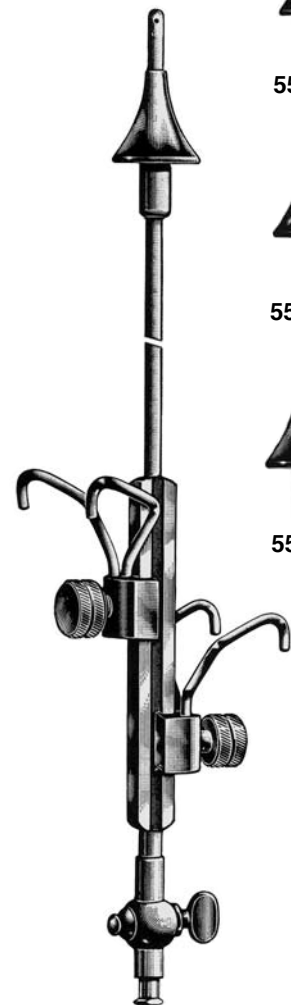

55.2291



55.2293

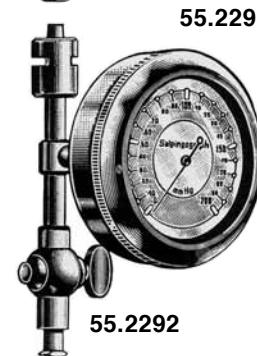

55.2292

SCHULTZE

55.2290 compl.

Amnioskop Tubus mit Mandrin
Amnioscope tube with obturator
Amniscope avec obturateur
Amnioscopio con mandril
Amnioscopio conico con otturatore



55.3500 Ø 12:24 mm / 20 cm



55.3502 Ø 16:24 mm / 20 cm



55.3504 Ø 20:24 mm / 20 cm

Amnioskop Tubus mit Mandrin zur Mikro-Blutentnahme
Amnioscope tube with obturator for micro blood extraction
Amniscope avec obturateur pour micro-extraction du sang
Amnioscopio con mandril para micro-extraccion del sangre
Amnioscopi per salasso, conico, con otturatore

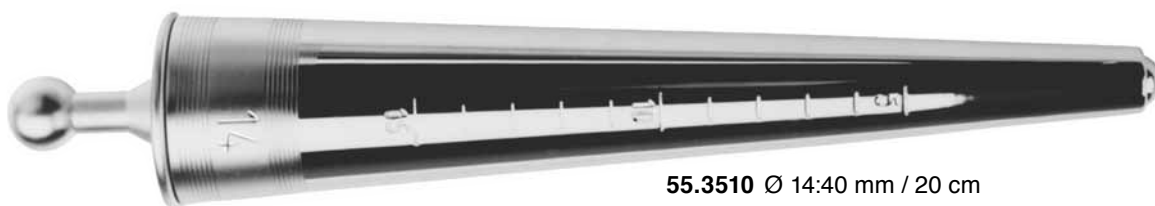

55.3510 Ø 14:40 mm / 20 cm



55.3512 Ø 18:40 mm / 20 cm



55.3514 Ø32:40 mm / 14 cm



55.3530

VAGINOSKOP 65 x Ø 10 mm mit Kaltlicht-Anschluss
ACMI,WOLF,STORZ

VAGINOSCOPE 65 x Ø 10 mm with Cold-light attachment
(ACMI,WOLF,STORZ)

VAGINOSCOPE 65 x Ø 10 mm avec lumière froide
(ACMI,WOLF,STORZ)

VAGINOSCOPIO 65 x Ø 10 mm con alumbrado frio
(ACMI,WOLF,STORZ)

VAGINOSCOPIO 65 x Ø 10 mm fibra ottica (ACMI,WOLF,
STORZ)



55.3600

KALTLICHT-Klammer für Proktoskope & Amnioskope,
Vaginal Spekula mit Kombistecker für alle Systeme

COLDLIGHT-Clip for proctoscopes & amnioscopes
vaginal specula with combi-plug for all systems

CLIP - lumière froide pour proctoscopes, amnioscopes,
spéculum vaginaux avec fiche utilisable pour tous
systèmes

CLIP - luz fria para proctoscopios, amnioscopios,
espéculos vaginales con clavija para todos sistemas

CLIP - illuminazione alogena per proctoscopios, specoli
vaginali e amnioscopios per tutti sistemi

GEBURTSHILFE
OBSTETRICS
OBSTETRIQUE
OBSTETRICIA
OSTETRICIA



Empfohlene Operationsbestecke für den Bereich "GEBURTSHILFE"
(Details erhalten Sie über Ihren Fachhändler)

Suggested Instrument Sets for "OBSTETRICS"
(Please ask your dealer for details)

Suggestions de boîtes opératoires pour le secteur "ACCOUCHEMENT".
(Pour plus de détails veuillez contacter votre distributeur.)

Cajas quirúrgicas para "OBSTETRICA" (para detalles póngase en contacto con su distribuidor)

Strumentari raccomandati per "OSTETRICA"
(Per ulteriori informazioni, vi preghiamo di contattare il Vostro rivenditore)

SET 56.0100 GYNECOLOGY / OBSTETRIC SET

SET 56.0200 PELVIC SET

SET 56.1000 OBSTETRICAL INSTRUMENT SET

SET 56.2000 DELIVERY SET

SET 56.2100 CAESAREAN SECTION TRAY

SET 56.3000 EPISIOTOMY / LACERATION REPAIR SET

SET 56.3100 UTERINE EVACUATION

SET 56.3200 EMBRYOTOMY SET

SET 56.5000 DECAPITATION SET

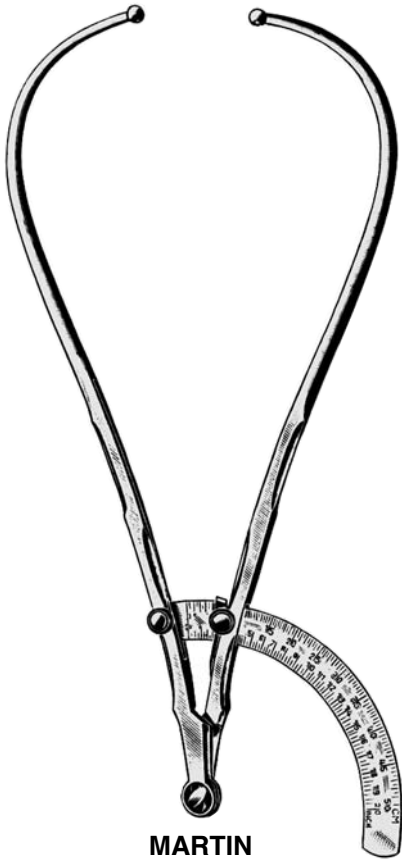

MARTIN
56.0010
34 cm



COLLYER
56.0020
30 cm

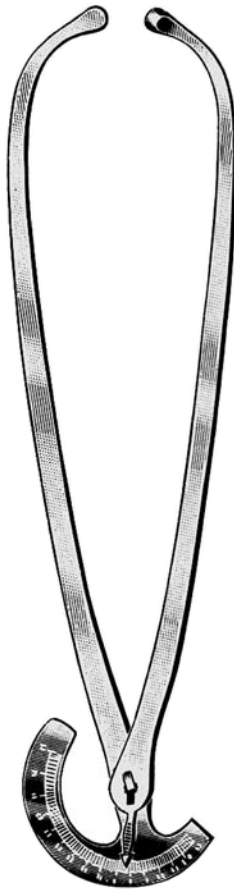

COLLIN
56.0030
35 cm

für Innenmessung
for internal measuring
pour mesurer à l'intérieur
para medir en la interior
paer misurare all' interiore



DE LEE
56.0050
20 cm

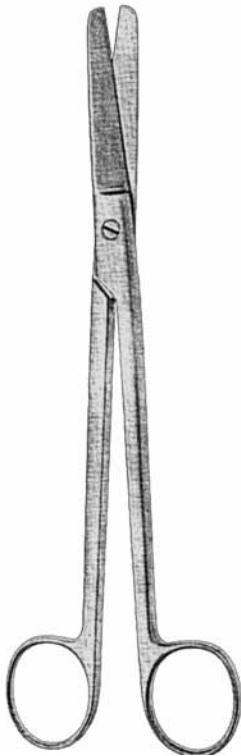

13.2101 20 cm **13.2101SC**
 13.2103 23 cm **13.2103SC**



SIMS

13.2100 20 cm **13.2100SC**
 13.2102 23 cm **13.2102SC**

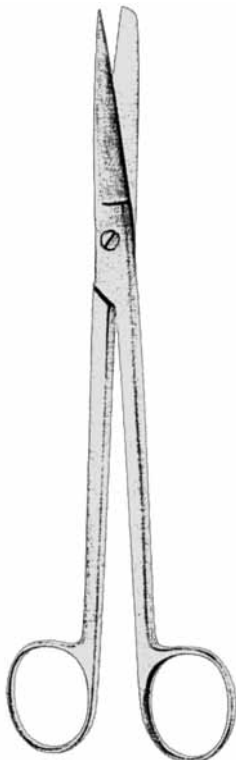

13.2111 20 cm
 13.2113 23 cm



SIMS

13.2110 20 cm
 13.2112 23 cm

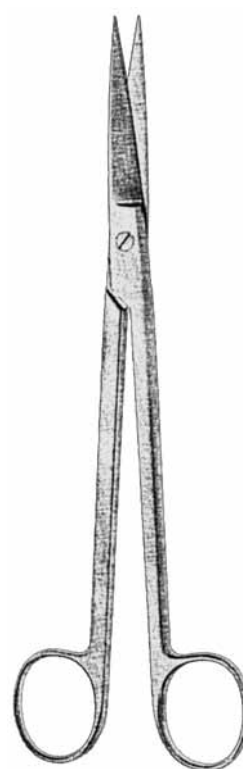

13.2121 20 cm
 13.2123 23 cm



SIMS

13.2120 20 cm
 13.2122 23 cm

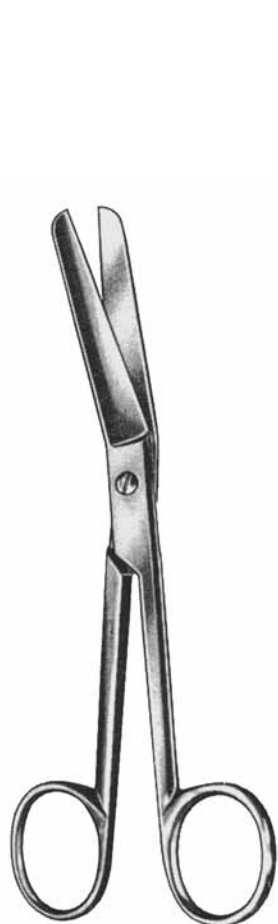

FERGUSON
 13.2134 18 cm

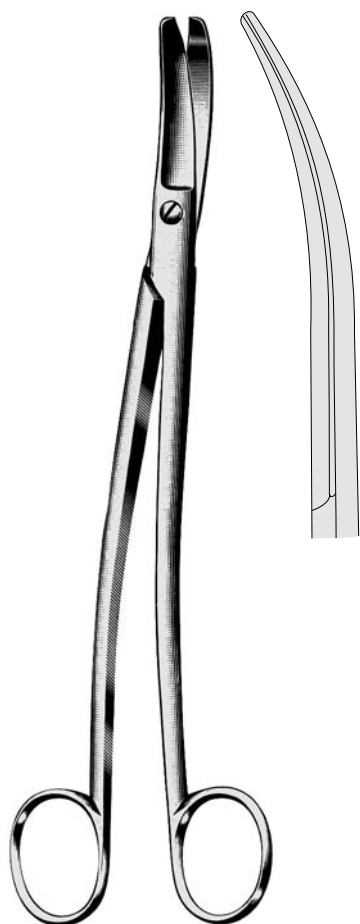

SIEBOLD
 13.2150 24 cm

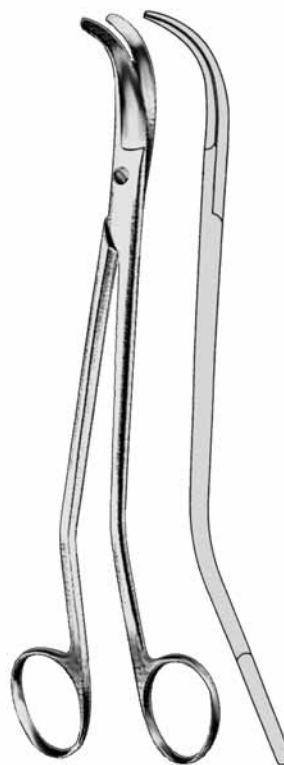

BOZEMANN
 13.2155 21 cm

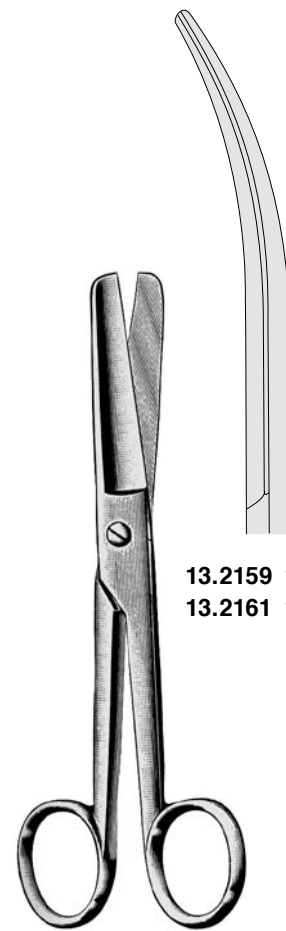

13.2159 16 cm
 13.2161 18 cm

DOYEN
 13.2158 16 cm
 13.2160 18 cm

Nabelschnurscheren
 Umbilical scissors
 Ciseaux pour section de cordon
 Tijeras umbilicales
 Forbici ombelicali



SCHUMACHER
 13.2210 15 cm



UMBILICAL-USA
 13.2220 10 cm

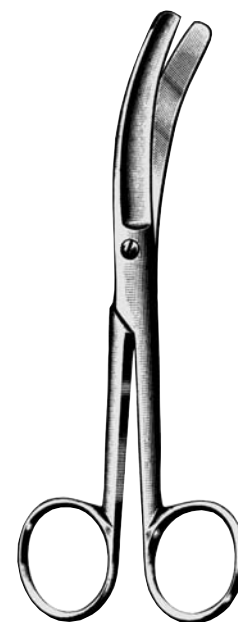

BUSCH
 13.2232 16 cm



Kephalatomiescheren
 Decapitating scissors
 Ciseaux à détroncation
 Tijeras para decapitación
 Forbici per decapitazione

Damm- (Episiotomie) Scheren
 Perineum (Episiotomy) Scissors
 Ciseaux à périnée (à ,épisiotomie)
 Tijeras para perineo (Episiotomia)
 Forbici per perineo (episiotomia)



BRAUN-STADLER
 13.2200 14 cm
 13.2202 22 cm
 Episiotomy

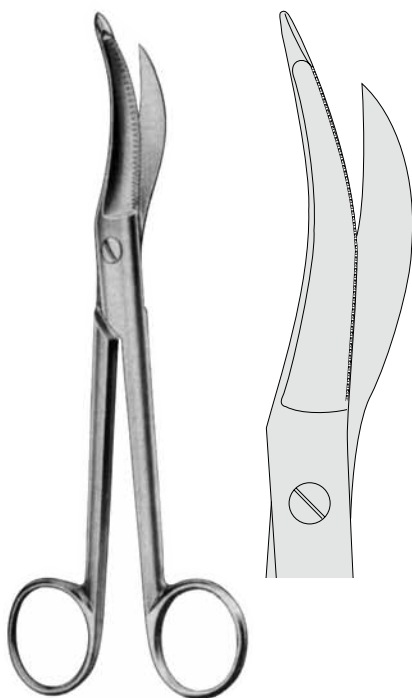

WALDMAN
 13.2240 18 cm **13.2240SC**
 13.2244 20 cm
 13.2246 24 cm
 Episiotomy

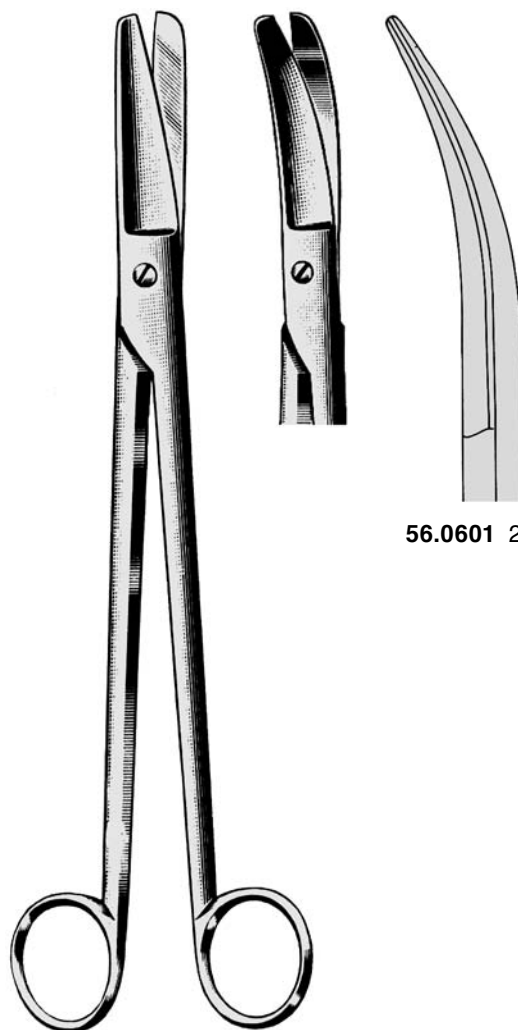

DUBOIS
 56.0600 27 cm

56.0601 27 cm

Geburtszangen für section caesares (Schnittentbindung)
 Forceps for caesarean section
 Forceps pour césarienne
 Fórceps para operación cesárea
 Forcipi per tagli cesarei

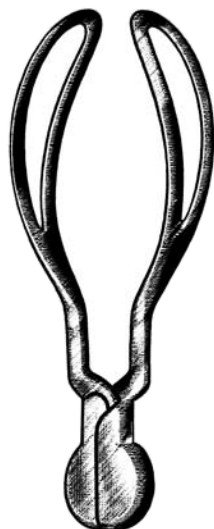

SIMPSON
 56.0224
 23 cm

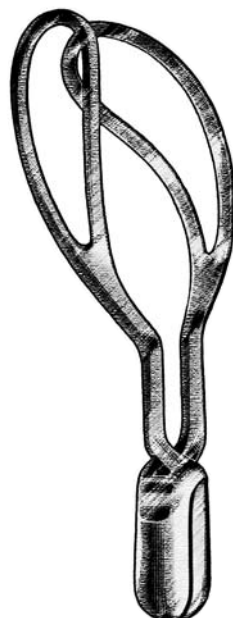

WRIGLEY
 56.0226
 25 cm

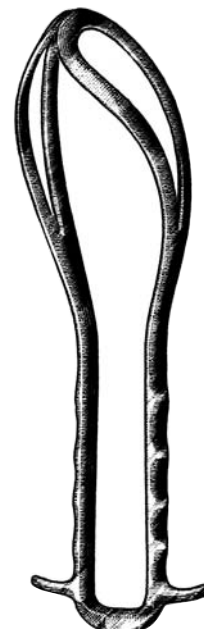

BOERMA
 56.0240
 28 cm

Kopfhebel für unteres Segment bei Kaiserschnitt
 Head extractor for lower segment in caesarean section
 Levier à tête utilisé en cas de césarienne
 Elevador para cabeza usándose en le segmento inferior
 del utero en casos de operaciones dcesáreas
 Elevatore per testa in interventi con taglio cesareo



MURLESS
 56.0400 26 cm

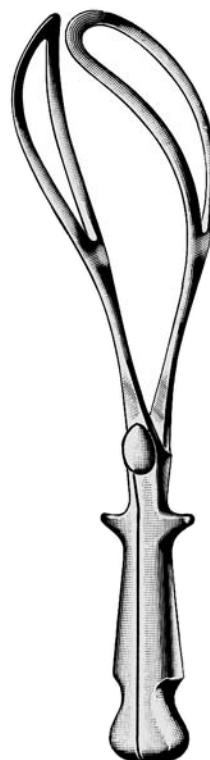
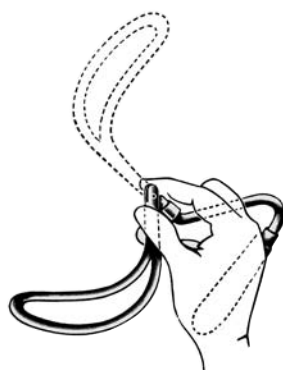

NAEGELE (DeLEE)
 56.0200 36 cm
 56.0202 40 cm

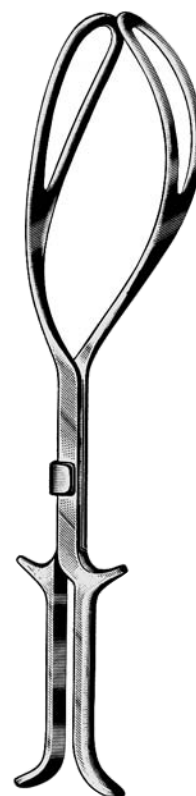

KIELLAND
 56.0210
 41 cm

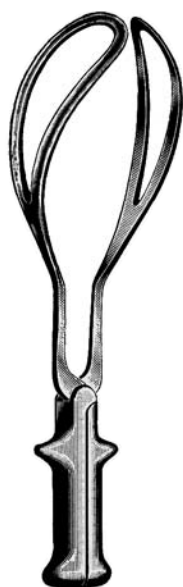

DeLEE
56.0220
30 cm

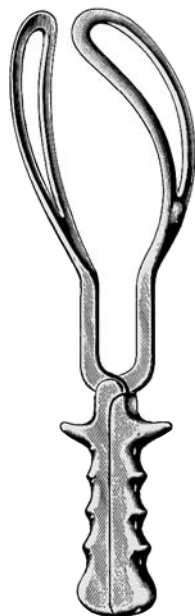

SIMPSON-BRAUN
56.0222
36 cm

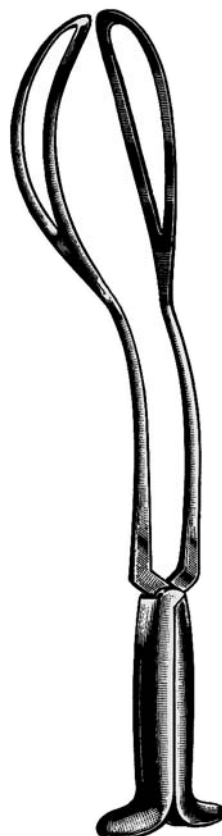

PIPER
56.0230
44 cm



ELLIOT
56.0250 32 cm
56.0252 38 cm

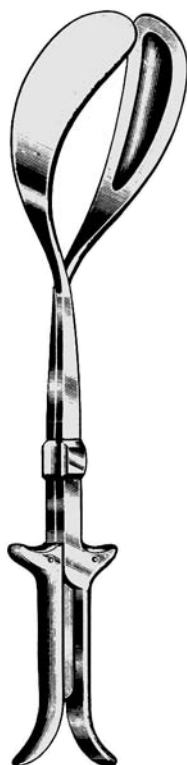

LUIKART
56.0260 40 cm



KIELLAND-LUIKART
56.0262 40 cm

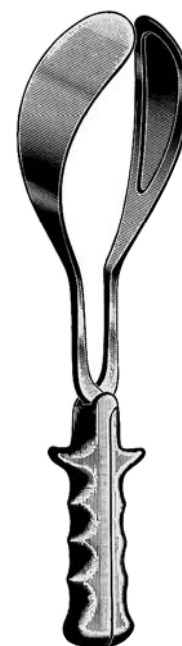

SIMPSON-LUIKART
56.0265 36 cm



McLEAN-LUIKART
 56.0270 39 cm



McLEAN-TUCKER
 56.0272 39 cm



McLEAN
 56.0274 36 cm

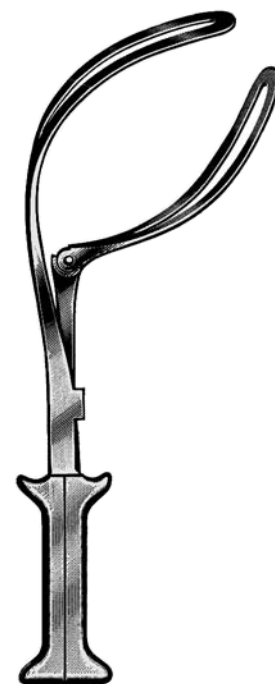

BARTON
 56.0280 36 cm

Zughebel
 Traction handle
 Tracteur
 Tractor
 Trattore

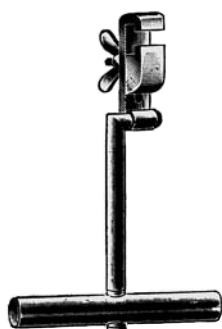

BARTON
 56.0289

mit Zughebel
 with traction handle
 avec tracteur
 con tractor
 con trattore



DEWEY
 56.0290 37 cm

mit Zughebel
 with traction handle
 avec tracteur
 con tractor
 con trattore

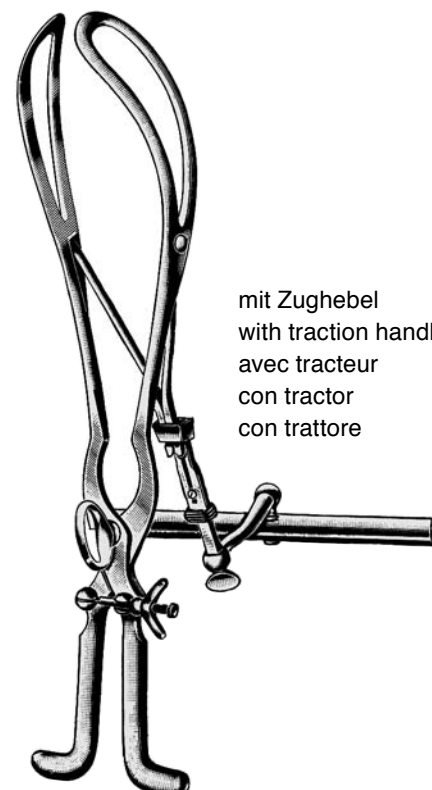

TARNIER
 56.0300 40 cm



PIPER
 56.0310 40 cm
 mit Zughebel
 with traction handle
 avec tracteur
 con tractor
 con trattore

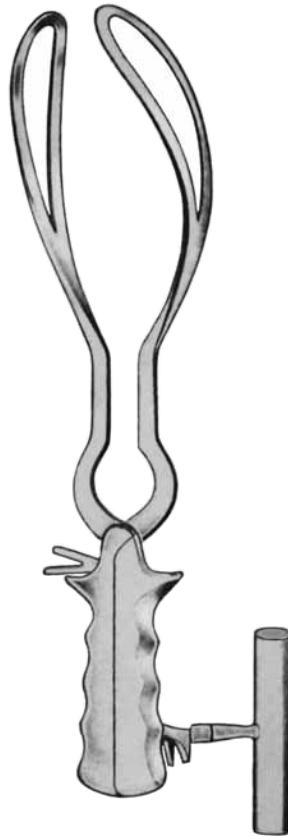

BARNES-NEVILLE
 56.0320 41 cm
 mit Zughebel
 with traction handle
 avec tracteur
 con tractor
 con trattore

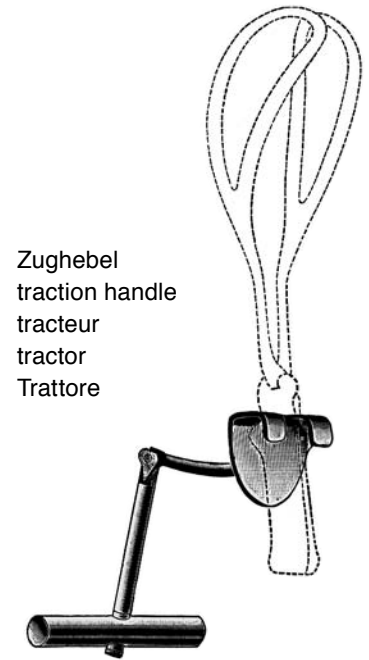

Zughebel
 traction handle
 tracteur
 tractor
 Trattore

BILL
 56.0350

Zughebel, passend für alle Geburtszangen
 mit gehörntem Standard-Griff

Tractor handles fitting all forceps with
 standard type handle

Tracteurs pour tous les forceps avec man-
 ches ordinaires

Tractors adecuados para todas las fórceps
 con mango standard

Trattore adatto a tutte le forcipi con manico
 standard

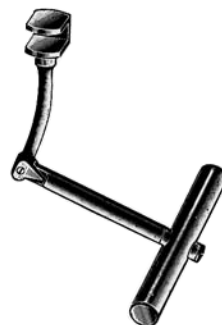

LUIKART-BILL
 56.0360

Geburtslöffel
 Obstetrical Lever
 Levier obstétrique
 Elevador obstetrico
 Leva ostetrica



SELLHEIM
 56.0410 28 cm

Geburtshaken
Obstetrical hook
Crochet à obstétrique
Gancho para partos
Uncino ostetrico



SMELLIE
56.0515 33 cm

Nabelschnurklemmen
Umbilical Cord Clamps
Clamps pour cordon umbilical
Clamps para cordon umbilical
Clamps ombelicali

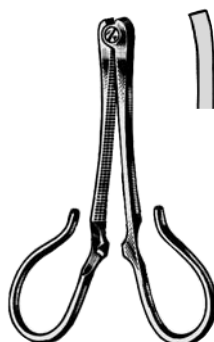

KANE
56.0700
8,5 cm



COLLIN
56.0702
9 cm

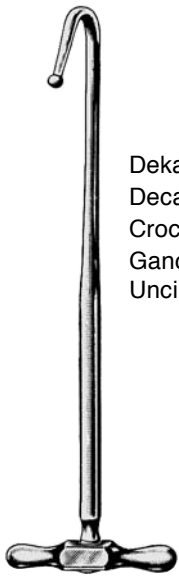

Dekapitationshaken
 Decapitating hook
 Crochet pour détroncation
 Gancho para decapitación
 Uncino di decapitazione

BRAUN
56.0505
 33 cm



NAEGELE
56.0506
 25 cm

Perforatorien
 Perforators
 Perces-crâne
 Perforadores-cranei
 Spezzecrani

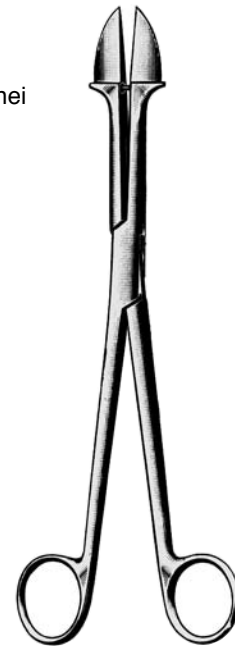

SMELLIE
56.0510
 25 cm

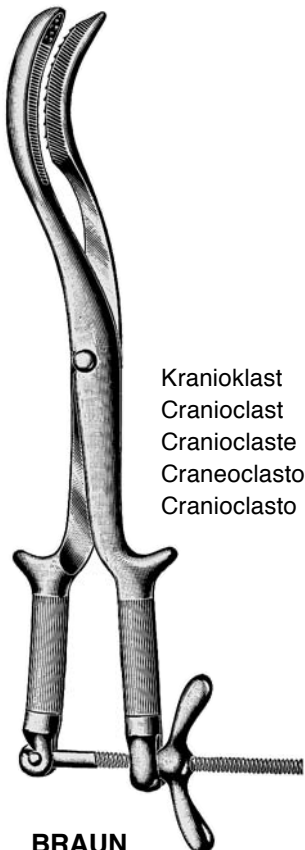

Kranioklast
 Cranioclast
 Cranioclaste
 Craneoclasto
 Cranioclasto

BRAUN
56.0500
 42 cm

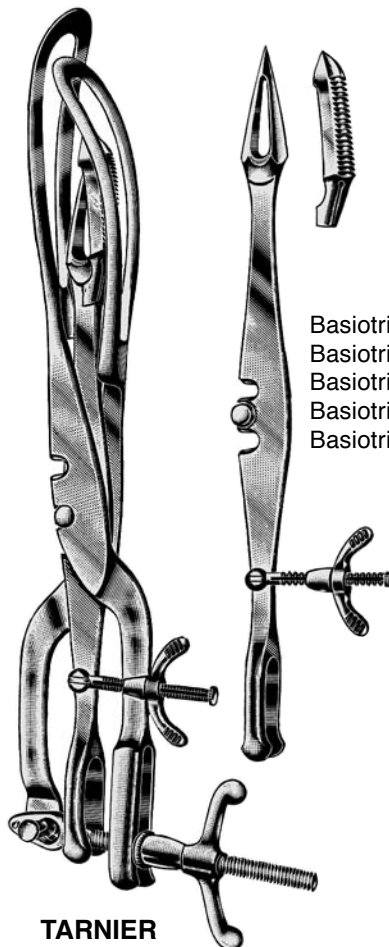

Basiotrib
 Basiotribe
 Basiotribe
 Basiotribo
 Basiotribo

TARNIER
56.0520
 46 cm

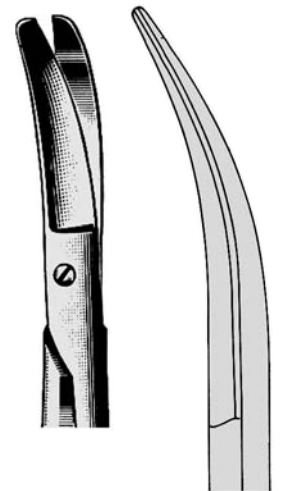

DUBOIS
56.0601
 27 cm

Kephalotomiescheren
 Decapitating (Embryotomy) Scissors
 Ciseaux à détroncation
 Tijeras para decapitación
 Forbici per decapitazione

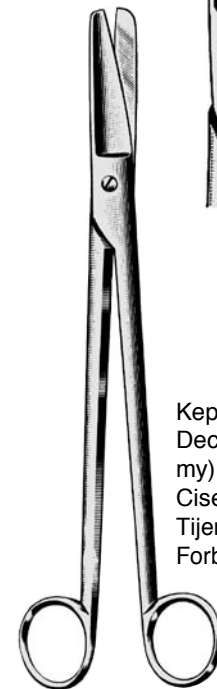

DUBOIS
56.0600
 27 cm

Klemmzange / Uterine Hemostatic Forceps /
Pince-Clamp utérine / Pinza-Clamp uterina / Pinza-Clamp uterina

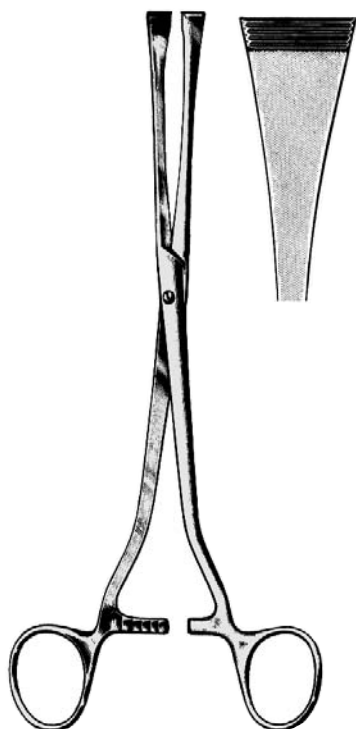

GREEN-ARMYTAGE
56.0800 22 cm

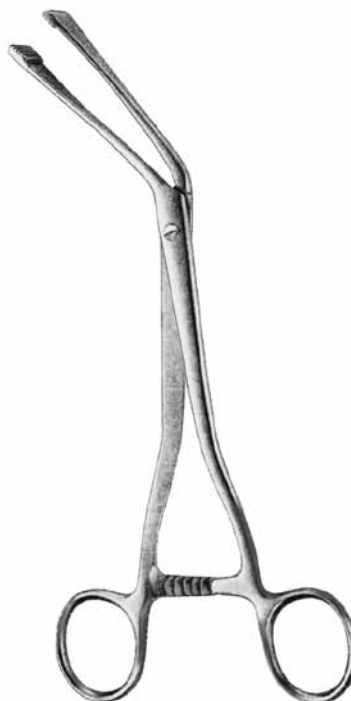

GREEN-ARMYTAGE
56.0801 20 cm

Kopfschwartenzangen / Scalp flap forceps / Pincés pour le
cuir chevelu / Pinzas para pericráneo / Pinze per pericráneo

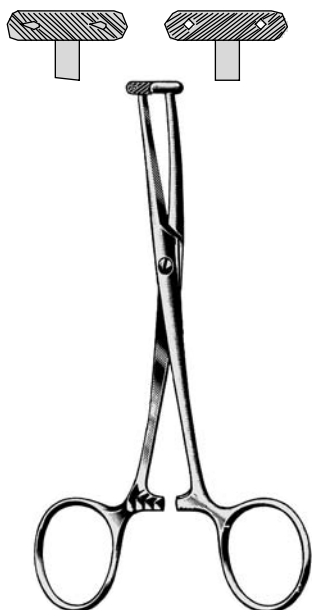

MARTEL
15.1340 14 cm



WILLET
15.1342 19 cm



GAUSS
56.0805 26 cm

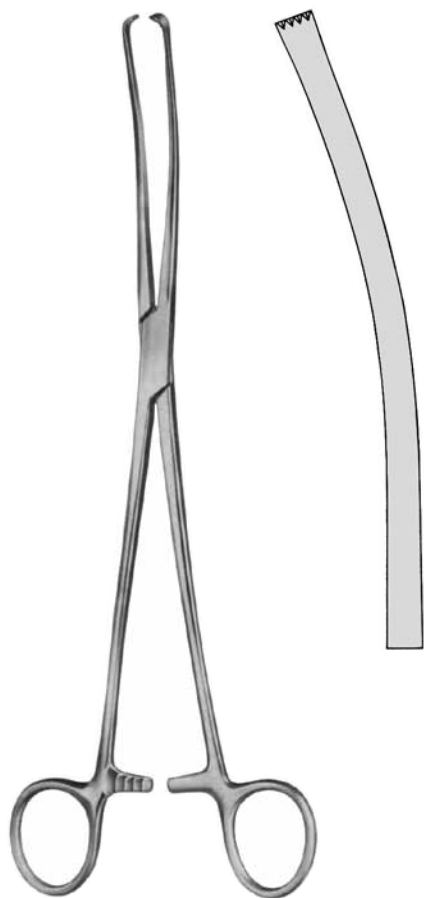

Blasensprenger
Membrane puncturing forceps
Pince perce-membrane
Pinza rompe membrana
Pinza rompere membrana

IOWA
56.0820 26 cm

Instrument zur transvaginalen Anaesthetie
Transvaginal anaesthesia instrument
Instrument pour l'anesthetie des organes g nitaux externes
Instrumento para la anestesia transvaginal
Strumento per anestesia paracervicale



IOWA
56.0740 15 cm

56.0748 14 cm
Nadelf hrung alleine
Needle Guide only
Guide-aiguilles seul
Gu a-agujas suelto
Guida per aghi

56.0749
Kan le, allein 1,5 x 150 mm
Needle only, 1,5 x 150 mm
Aiguille seul, 1,5 x 150 mm
Aguja suelta, 1,5 x 150 mm
Ago solo 1,5 x 150 mm

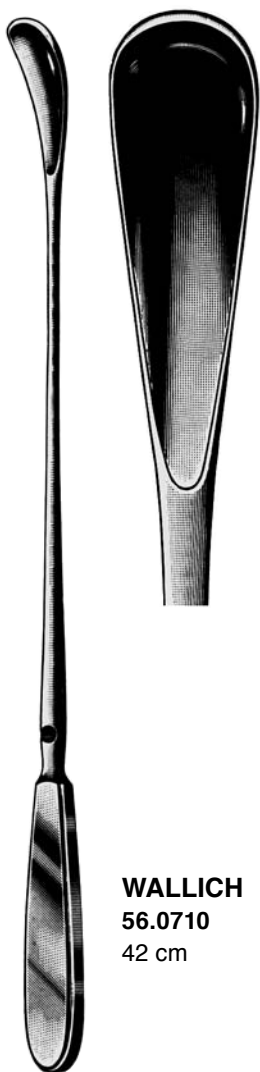

WALLICH
56.0710
42 cm

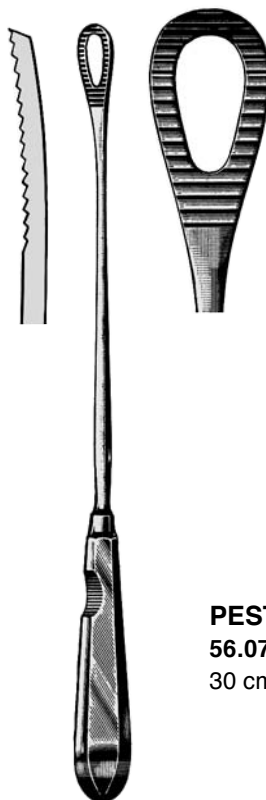

PESTALOZZA
56.0720
30 cm



CUZZI

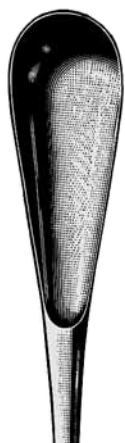

56.0721
30 cm / 14 mm



56.0722
30 cm / 18 mm

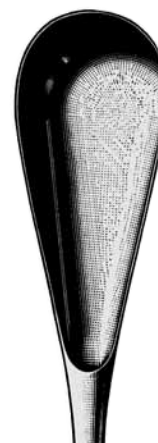

56.0723
30 cm / 21 mm

Uterus-Polypenzangen / Uterine Polypus Forceps /
Pincès à polypes utérines / Pinzas para pólipos uterinos /
Pinze per polipi uterini



HEYWOOD-SMITH

56.0880 21 cm

56.0882 25 cm

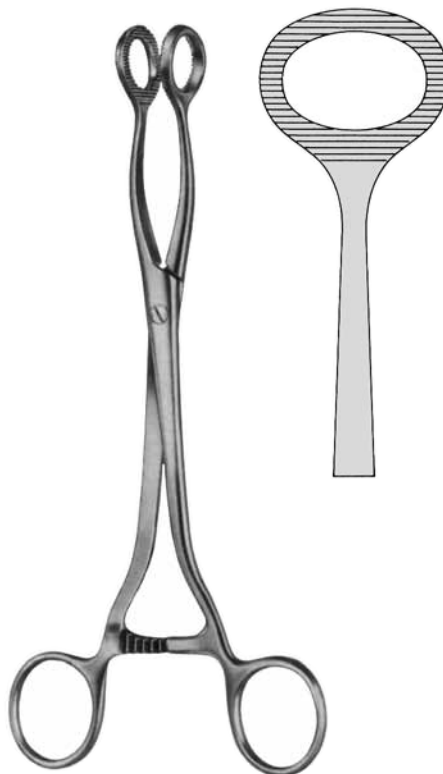

DOYEN

56.0890 20 cm



NOTO

56.0896 27 cm



BUMM

56.0898 28 cm

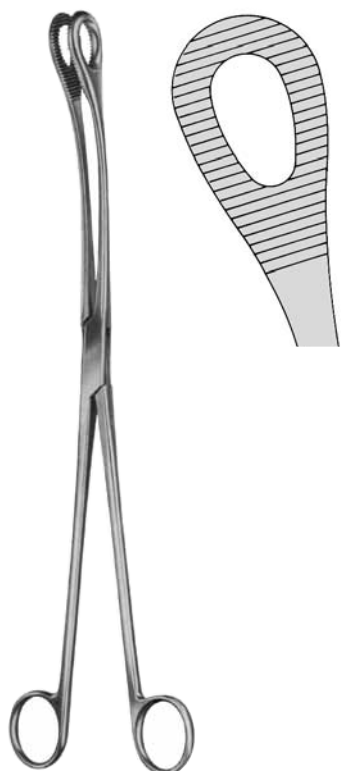

KELLY
 56.0900 32 cm

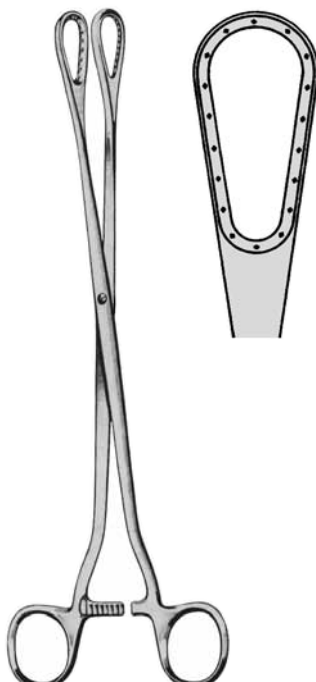

SAENGER
 56.0910 27 cm

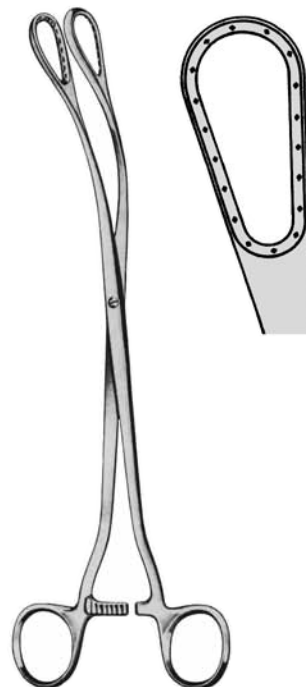

SAENGER
 56.0911 27 cm

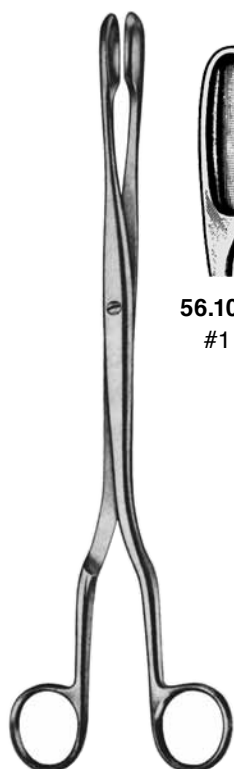

WINTER
 29 cm

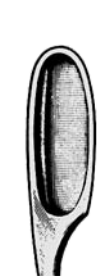

56.1000
 #1

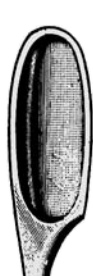

56.1002
 #2

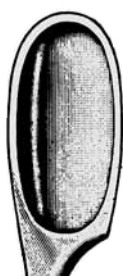

56.1004
 #3

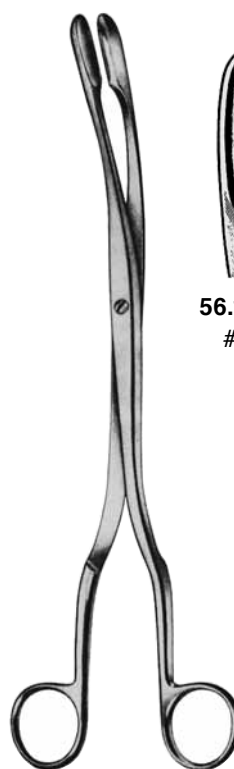

WINTER
 29 cm

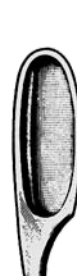

56.1001
 #1



56.1003
 #2

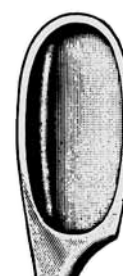

56.1005
 #3

ALLGEMEINE INSTRUMENTE
GENERAL INSTRUMENTS
INSTRUMENTS GENERAUX
INSTRUMENTOS GENERALES
STRUMENTI GENERALI

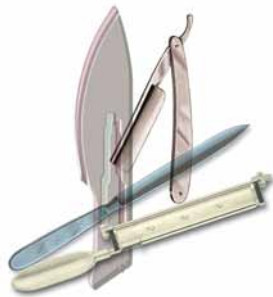

Blutdruckmesser
Blood Pressure Manometers
Tensiomètres
Sfigmanómetros
Sfigmanometri



10.0010 NOVA-PRESAMETER

Quecksilbergerät in Metalltui. Skala bis 300 mm Hg. Fehlertoleranz: +/- 3 mm Hg. Kalibrierte Velcromanschette mit Latexpolster 2-Schlauch.

Mercurial sphygmomanometer in metal case. Graduated scale; maximum reading 300 mm Hg. Maximum error throughout range +/- 3 mm Hg. Calibrated nylon velcro cuff with 2-tube latex bladder.

Appareil à colonne de mercure en boîtier métallique. Echelle anodisée jusqu'à 300 mm Hg. Tolérance maximale +/- 3 mm Hg. Avec brassard nylon-velcro, calibré, et vessie latex à 2 tubes.

Tensiómetro de mercurio en estuche metálico. Escala anodizada hasta 300 mm Hg. Tolerancia max +/- 3 mm Hg. Brazaletes velcro de nylon, calibrado, con bolsa latex de 2 tubos

Sfigmanometro in astuccio metallo, Scala 0 - 300 mmHg. Tolleranza +/- 3 mmHg. Bracciale calibrato velcro-nylon di camera d'aria di latex a 2-tubi.



10.0020 PRECISA N

Manometer-Blutdruckmessgerät; ergonomischer Löffelgriff; Lineare Skale 0 - 300 mm Hg; maximale Fehlertoleranz +/- 3 mmHg

Blood Pressure Manometer; Ergonomic spoon-shaped grip; linear, tilted aluminum scale from 0 to 300 mm Hg; max. error tolerance +/- 3 mmHg

Tensiomètre à cadran; poignée-cuillère ergonomique; graduation linéaire inclinée, de 0 à 300 mm Hg; tolérance max. d'erreur +/- 3 mmHg

Tensiómetro aneroides; Mango de cuchara ergonómico; Escala de aluminio lineal, inclinada, 0 - 300 mmHg; Máxima tolerancia de error de +/- 3 mmHg

Sfigmanometro moderno e economico. Scala 0 - 300 mmHg, 53 mm Ø. Valore massimo 300 mmHg. Tolleranza +/- 3 mmHg. Bracciale calibrato velcro-nylon di camera d'aria di latex a 1 tubo

Blutdruckmesser
Blood Pressure Manometers
Tensiomètres
Sfigmanómetros
Sfigmanometri



10.0030 MINIMUS II

Einhandmodell in Vinyltasche mit Reißverschluss. Keine Nullpunktfixierung. Gut ablesbare Aluminiumskala Ø 49 mm bis 300 mm Hg. Maximale Fehlertoleranz +/- 3 mm Hg. Mit kalibrierter Nylon-Velcromanschette komplett mit Latexpolster 1-Schlauch.

Palm-style sphygmomanometer in vinyl zipper case. Graduated aluminum scale Ø 49 mm. Maximum reading 300 mm Hg. Maximum error +/- 3 mm Hg. With calibrated nylon-velcro cuff and 1-tube latex bladder.

Manopire en étui vinyl avec fermeture éclair. Echelle Ø 49 mm jusqu'à 300 mm Hg. Tolérance maximale +/- 3 mm Hg. Avec brassard nylon-velcro calibré, et vessie latex à 1 tube.

Modelo de mano. Lectura de la escala Ø 49 mm hasta 300 mm Hg. Tolerancia max. +/- 3 mm Hg. Brazaletes velcro de nilón, calibrado; cámara d'aria de latex ad 1 tubo.

Sfigmanometro ad aneroide in borsa vinilpelle con cerniera lampo. Senza fissaggio a zero. Scala graduata in alluminio 49 mm Ø, 0 - 300 mmHg. Tolleranza +/- 3 mmHg. Bracciale calibrato velcro-nylon di camera d'aria di latex a 1 tubo



10.0040 EXACTA

Hochleistungs-Blutdruckmessgerät in 2-Schlauch-Ausführung. Lineare Skala Ø 40 mm, von 0 - 300 mm Hg; max. Fehlertoleranz +/- 3 mmHg

High quality Sphygmomanometer in a 2-tube version; Linear scale Ø 49 mm, 0 - 300 mmHg; Max. error tolerance +/- 3 mmHg

Tensiomètre à cadran de haute qualité à 2 tubes; Graduation linéaire, Ø 49 mm de 0 à 300 mmHg; tolérance max. d'erreur de +/- 3 mmHg

Tensiómetro de precisión de alta calidad, con 2 tubos; Escala lineal Ø 49 mm, 0 - 300 mmHg; Máxima tolerancia de error de +/- 3 mmHg

Sfigmanometro di alta prestazione. Scasla lineare 0 - 300 mmHg, 49 mm Ø. Tolleranza +/- 3 mmHg. Bracciale calibrato velcro-nylon di camera d'aria di latex a 2 tubi



kalibrierte Nylon-Velcromanschetten, 2-Schlauch
Calibrated nylon-velcro cuffs 2-tube
Brassards nylon-velcro calibré avec 2-tubes
Brazeletes velcro de nilón con 2 tubos
Bracciali velcro solo a 2 tubi

10.0080

für Erwachsene / for adults / pour adultes / para adultos / per adulti

10.0081

für Erwachsene (dünne Arme) / for adults (thin arms) / pour adultes (bras minces) / para adultos (brazos delgados) per adulti (braccie fine)

10.0082

für Oberschenkel /for femur / pour fémur / para muslo / per coscìe

10.0083

für Neugeborene / for newborn / p. nouveaux-nés / p. racien nacidas / per neonato

10.0084

für Säuglinge / for Infants / pour bébés / p. lactantes / per lattante

10.0085

für Kinder / for children / pour enfants / para niños / per bambini

kalibrierte Nylon-Velcromanschetten, 1-Schlauch
Calibrated nylon-velcro cuffs 1-tube
Brassards nylon-velcro calibré avec 1-tube
Brazeletes velcro de nilón con 1 tubo
Bracciali velcro solo a 1 tubo

10.0090

für Erwachsene / for adults / pour adultes / para adultos / per adulti

10.0091

für Erwachsene (dünne Arme) / for adults (thin arms) / pour adultes (bras minces) / para adultos (brazos delgados) per adulti (braccie fine)

10.0092

für Oberschenkel /for femur / pour fémur / para muslo / per coscìe

10.0094

für Neugeborene / for newborn / p. nouveaux-nés / p. racien nacidas / per neonato

10.0095

für Kinder / for children / pour enfants / para niños / per bambini

Stethoskope
Stethoscopes
Stéthoscopes
Estetoscopios
Stetoscopi



aus Aluminium
of aluminium
de aluminium
de aluminio
in alluminio

PINARD
10.0400
15 cm



aus Holz
of wood
de bois
de madera
in legno

PINARD
10.0410
18 cm



DUPLEX
10.0460



DUPLEX DE LUXE
10.0462

Mikro-Skalpellklingen und -griffe
 Micro Scalpel Blades and Handles
 Micro lames de bistouris et manches
 Micro hojas de bisturi y mangos
 Micro lame per bisturi e manici

in Packungen à 10 St.
 in packages of 10 ea.
 en boîtes de 10 pièces
 en cajas de 10 c/u
 en scatole di 10 pezzi



12.0061 #61 **12.0062** #62 **12.0062S** #62S **12.0065** #65 **12.0067** #67 **12.0069** #69

Griffe für Klingen
 handles for blades
 manches pour lames
 mangos para hojas
 manici per bisturi

12.0061 - 12.0069



12.0180 100 mm
12.0182 125 mm
12.0184 155 mm
12.0186 180 mm
12.0188 200 mm



LANDOLD
12.0153
 21 cm bajonett



LANDOLD
12.0157
 25 cm bajonett

steril, in Packungen à 100
sterile, in packages of 100
stériles, en boîtes de 100
estériles, en cajas de 100
sterili, confezione da 100



12.0010
10



12.0011
11



12.0012
12

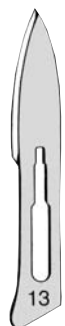

12.0013
13



12.0014
14



12.0015
15



12.0016
16



12.0017
17

Der „**PRO-MED SEKUR**™“ Klingenhalter ermöglicht das Einsetzen und Entfernen der Klingle, ohne den vorderen - kontaminierten - Teil der Klinge zu berühren

This „**PRO-MED SEKUR**™“ Blade handle allows inserting and removing of blades without touching the - contaminated - tip of blades.

Le porte-lames „**PRO-MED SEKUR**™“ permet la mise en place et l'enlèvement des lames sans toucher la partie coupante et contaminée de celles-ci..

El mango „**PRO-MED SEKUR**™“ permite aplicar y quitar la hoja sin tener que tocar su parte delantera contaminada.

Il portalama „**PRO-MED SEKUR**™“ permette l'applicazione delle lame senza entrare in contatto con la parte anteriore contaminata.



PRO-MED SEKUR™
12.0193
12,5 cm #3

für Klingle:
for blades:
pour lames:
para bisturis:
per bisturi:

Fig. 10, 11, 12, 13,
14, 15, 16, 17

PRO-MED SEKUR™
12.0194
13,5 cm #4

für Klingle:
for blades:
pour lames:
para bisturis:
per bisturi:

Fig. 18, 19, 20, 21,
22, 23, 24, 25
34, 36, 44, 46

Klinge im breiten Teil über oberen Stift des Klingenhalters setzen.

Insert lower end of blade into upper pin of blade handle

Tenir la lame en bas et introduire le pivot supérieur dans la partie élargie de la fente de la lame.

Introdur la hoja en la parte ancha de la clavija en el soporte de la hoja superior.

Innestare la lama con la parte più larga della sua apertura al perno terminale del portalama

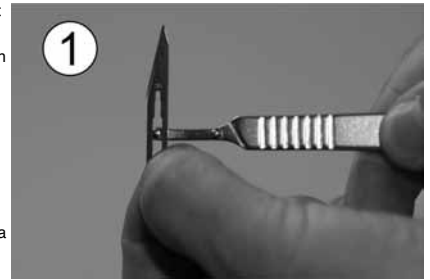

Klinge bis zum Anschlag nach unten ziehen

Pull blade all the way down

Tirer la lame jusqu'à la butée.

Tirar la hoja hacia abajo hasta el fondo.

Tirare la lama verso il basso fino al suo arresto

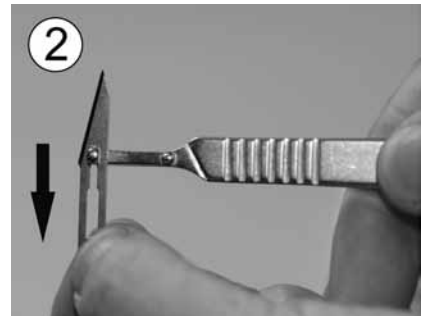

In Anschlagposition um 90° Grad drehen

Turn blade 90° until it touches lower pin of blade handle.

En position butoire tourner la lame à 90°.

En posicion del fondo girar la hoja ha 90°.

Ruotare di 90° verso l'alto fino a raggiungere il secondo perno prossimo all'impugnatura

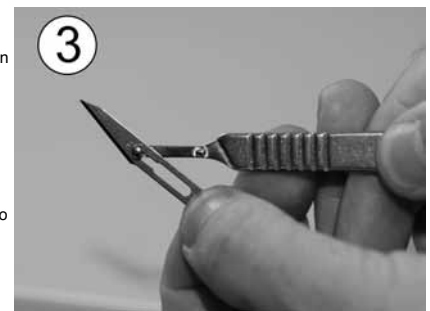

Klingenende wird über den unteren Stift des Klingenhalters gehoben

Lift end of blade over lower pin of blade handle

Passer la lame par dessus la tige inférieure du manche

Coger la hoja por el extremo inferior, levantada hacia la clavija

Innestare la parte posteriore della lama al perno prossimo all'impugnatura del portalama

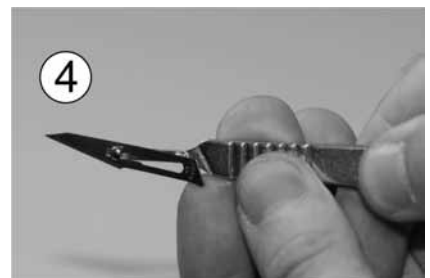

Klinge rastet ein und ist fixiert und gebrauchsfertig - Entfernen der Klinge in umgekehrter Reihenfolge

Lock blade into place which is now ready for use. - Remove blade in reverse order

La lame s'encliquète, est fixée et prête à l'emploi. - Oter la lame par ordre inverse.

La hoja se involucra se fija y listo para usar. - Retire la hoja en orden inverso.

La lama è pronta all'uso - Per rimuovere la lama operate in senso inverso

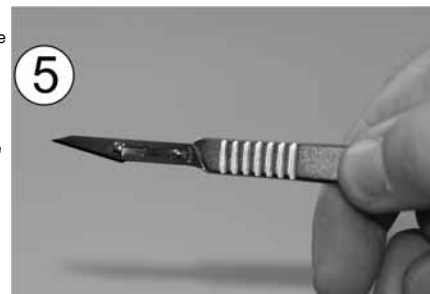

Griffe für Klagen
 Handles for Blades
 Manches pour lames
 Mangos para bisturis
 Manici per bisturi Fig.

Fig. 10,11,12,12d,13,14,15,15c,16,17,

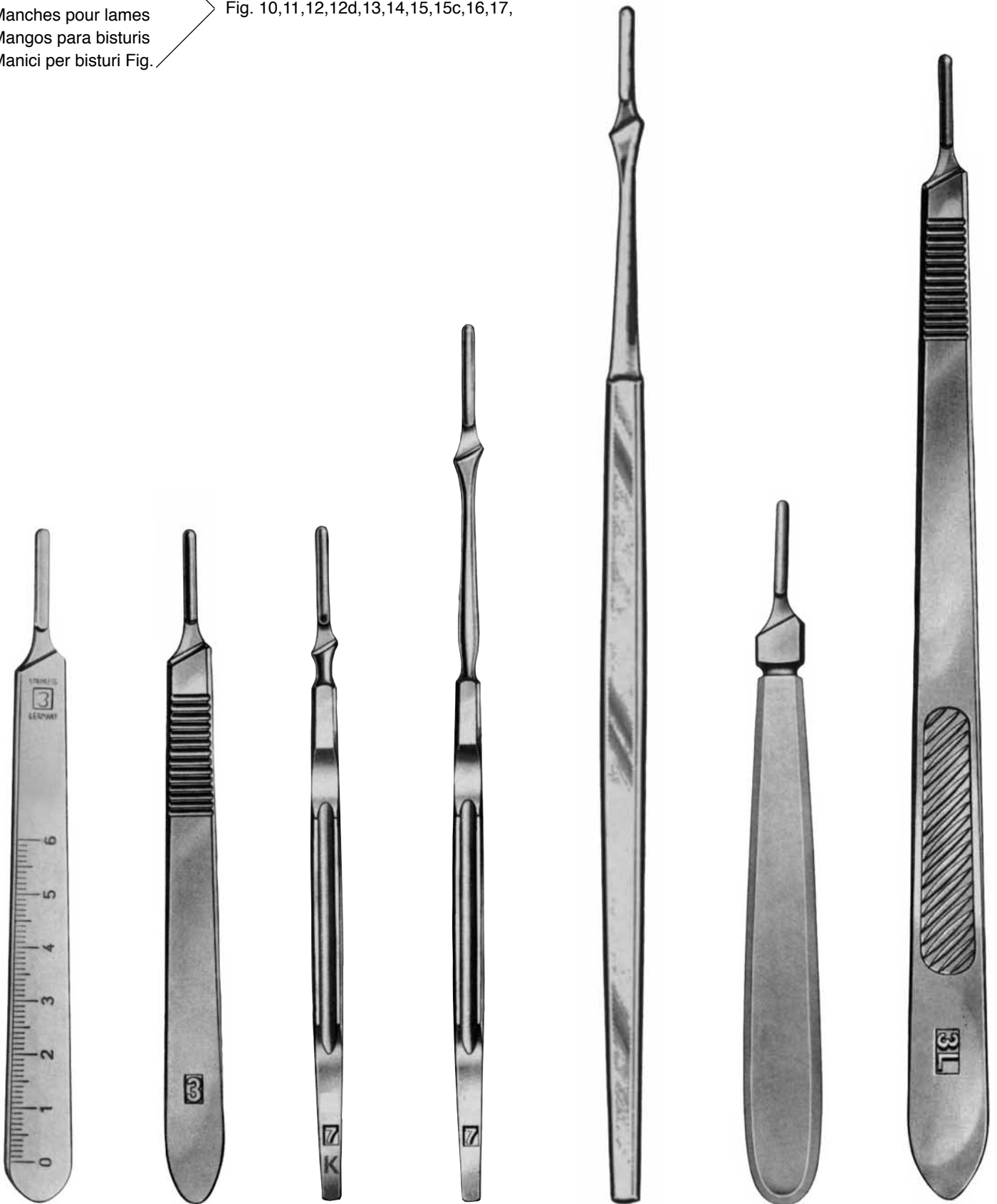

12.0101
 Technical #3

12.0103
 #3 12 cm

12.0106
 #7 K 12,5 cm

12.0107
 #7 16 cm

12.0127
 #7 L 22,5 cm

COLLIN
12.0108
 #8 13 cm

12.0113
 #3 L 21 cm

Griffe für Klagen
 Handles for Blades
 Manches pour lames
 Mangos para bisturis
 Manici per bisturi

Fig. 10,11,12,12d,13,14,15,15c,16,17,



12.0115
 #3 L 20 cm



12.0123
 #5, 16 cm



12.0125
 #5, 16 cm



12.0133
 #3, 21cm



BARRON
12.0163
 #3 13 cm



12.0173
 12,5 cm

Kunststoffgriff
 plastic handle
 manche en plastique
 mango plástico
 manico plastica

steril, in Packungen à 100
 sterile, in packages of 100
 stériles, en boîtes de 100
 estériles, en cajas de 100
 sterili, confezione da 100



12.0018
18



12.0019
19



12.0020
20



12.0021
21



12.0022
22



12.0023
23



12.0024
24



12.0025
25



12.0034
34



12.0036
36

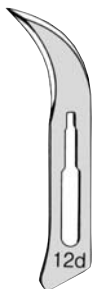

12.0042
12 d



12.0044
24 d



12.0045
15 c



12.0046
36 d

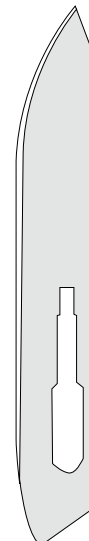

POST-MORTEM
12.0060
60

nicht steril
 not sterile
 pas stériles
 no estériles
 non sterile

Griffe für Klengen
 Handles for Blades
 Manches pour lames
 Mangos para bisturis
 Manici per bisturi

Fig. 18,19,20,21,22,23,24,25,34,36,44,46

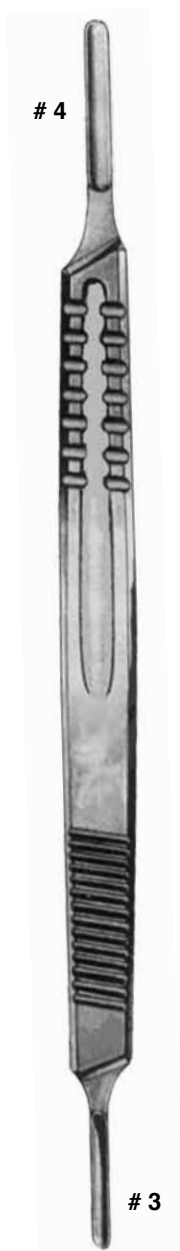

12.0105
 # 3/4 16 cm

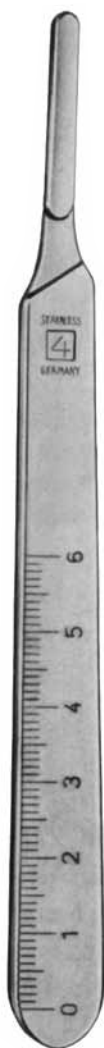

12.0102
 Technical #4



12.0104
 #4 12 cm



COLLIN
12.0109
 #9 14 cm

Griffe für Klagen
 Handles for Blades
 Manches pour lames
 Mangos para bisturis
 Manici per bisturi

Fig. 18,19,20,21,22,23,24,25,34,36,44,46

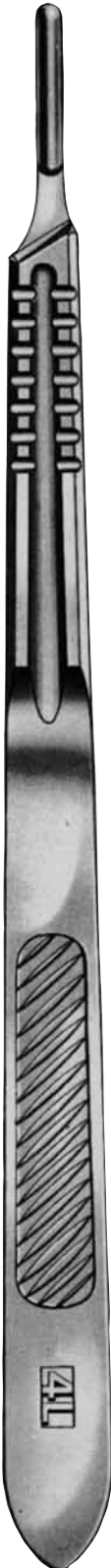

12.0114
 #4 L 21 cm



12.0117
 #4 L 20 cm



KLING-EX
12.0070
 Skalpelklagen-Abnehmer
 Scalpel-blade remover
 Oteur-bistouris
 Quita hojas
 togliere-lame



Kunststoffgriff
 plastic handle
 manche en plastique
 mango plástico
 manico plastica

12.0174
 13,5 cm

SCHEREN
SCISSORS
CISEAUX
TIJERAS
FORBICI



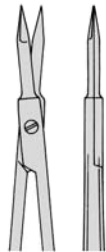

28.2112
18,5 cm



28.2113
18,5 cm



28.2114
23 cm

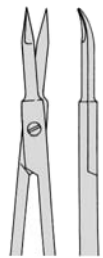

28.2115
23 cm



VANNAS-MIKRO

VANNAS-MIKRO



28.2102
15 cm
Ø 8 mm
28.2104
18cm



28.2103
15 cm
Ø 8 mm
28.2105
18 cm



28.2124
18 cm / Ø 8 mm
gerade / straight
droit / recto / retto



28.2150 (GYN)
18 cm / Ø 8 mm
gerade / straight
droit / recto / retto



28.2125
18 cm / Ø 8 mm
gebogen / curved
courbe / curvo /
curvo

28.2151 (GYN)
18 cm / Ø 8 mm
gebogen / curved
courbe / curvo /
curvo

VANNAS-MIKRO

TITANIUM



18 cm



28.2460
28.2460T
 25°



28.2470
28.2470T
 25°



28.2461
28.2461T
 45°



28.2471
28.2471T
 45°



28.2462
28.2462T
 60°



28.2472
28.2472T
 60°



28.2463
28.2463T
 90°



28.2473
28.2473T
 90°



28.2464
28.2464T
 125°



28.2474
28.2474T
 125°



18 cm

mit 1 geknöpften Blatt
 1 probe-pointed blade
 1 lame boutonée
 1 punta botonada
 1 lame abbottona



28.2600 16,5 cm
28.2602 20,0 cm



28.2601 16,5 cm
28.2603 20,0 cm



28.2605 20,0 cm



28.2608 20,0 cm



28.2609 20,0 cm



28.2620 22,5 cm



28.2623 22,5 cm
28.2625 24,5 cm



28.2624 22,5 cm

28.2622 22,5 cm
 gezahnt
 serrated
 dentelées
 dentada
 dentate



28.2628 22,5 cm



28.2629 22,5 cm



28.2640 22,5 cm



28.2641 22,5 cm

VANNAS



NAGEL

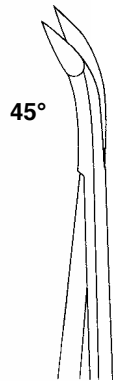

45°

28.2656 20,0 cm

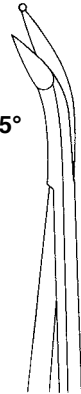

45°

28.2657 20,0 cm

geknöpft
button-end
boutonée
abotonada
con 1 lama abbottona



125°

28.2659 20,0 cm

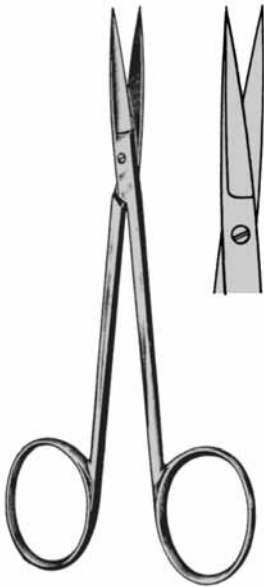

IRIS

- 13.0010 9,0 cm
- 13.0010SC** 9,0 cm
- 13.0012 10,5 cm
- 13.0012SC** 10,5 cm
- 13.0014 11,5 cm
- 13.0014SC** 11,5 cm

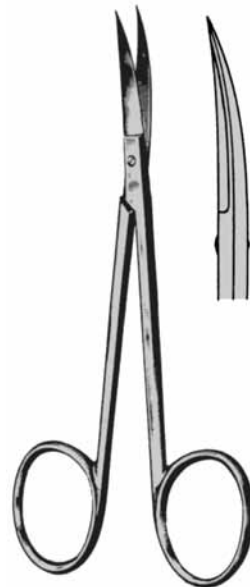

IRIS

- 13.0011 9,0 cm
- 13.0011SC** 9,0 cm
- 13.0013 10,5 cm
- 13.0013SC** 10,5 cm
- 13.0015 11,5 cm
- 13.0015SC** 11,5 cm



IRIS

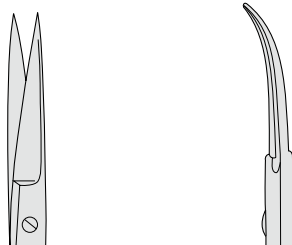

- 13.0012L 10,5 cm 13.0013L 10,5 cm
- 13.0012LSC** 10,5 cm **13.0013LSC** 10,5 cm

linkshändig / left handed /
 pour gaucher / para zurdo / per mano sinistra

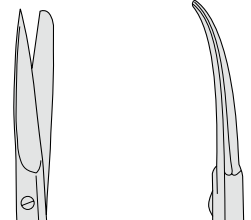

- 13.0022 10 cm 13.0023 10 cm

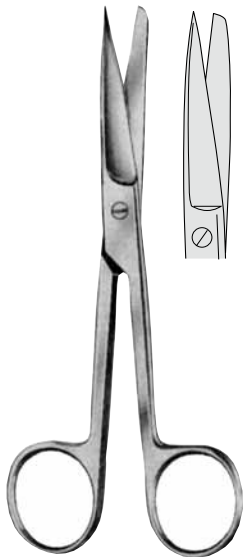

- 13.0300 11,5 cm
- 13.0302 13,0 cm
- 13.0302SC** 13,0 cm
- 13.0304 14,5 cm
- 13.0304SC** 14,5 cm
- 13.0306 15,5 cm
- 13.0308 16,5 cm
- 13.0308SC** 16,5 cm
- 13.0310 18,5 cm
- 13.0312 20,0 cm



- 13.0304L** 14,5 cm
- linkshändig
- left-handed
- pour gaucher
- para zurdo
- per mano sinistra



- 13.0394** 14,5 cm
- gezahnt
- serrated
- dentées
- dentadas
- dentata

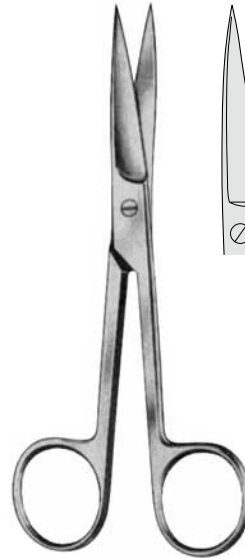

- 13.0330 11,5 cm
- 13.0330SC** 11,5 cm
- 13.0332 13,0 cm
- 13.0334 14,5 cm
- 13.0334SC** 14,5 cm
- 13.0336 15,5 cm
- 13.0338 16,5 cm
- 13.0340 18,5 cm
- 13.0342 20,0 cm

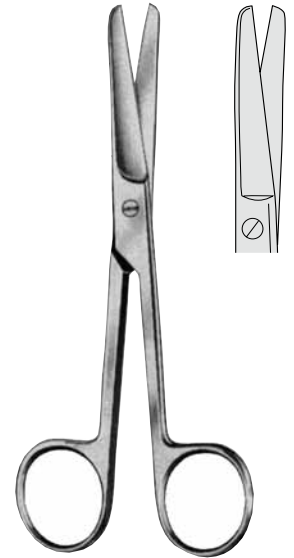

- 13.0350 11,5 cm
- 13.0352 13,0 cm
- 13.0352SC** 13,0 cm
- 13.0354 14,5 cm
- 13.0354SC** 14,5 cm
- 13.0356 15,5 cm
- 13.0358 16,5 cm
- 13.0358SC** 16,5 cm
- 13.0360 18,5 cm
- 13.0360SC** 18,5 cm
- 13.0362 20,0 cm

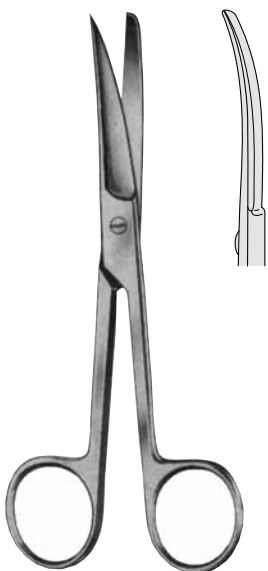

- 13.0301 11,5 cm
- 13.0303 13,0 cm
- 13.0305 14,5 cm
- 13.0307 15,5 cm
- 13.0309 16,5 cm
- 13.0311 18,5 cm
- 13.0313 20,0 cm

- 13.0301SC**
- 13.0303SC**
- 13.0305SC**
- 13.0309SC**

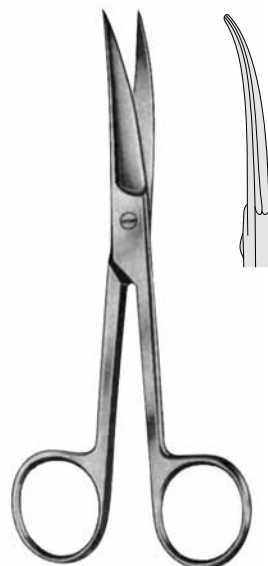

- 13.0331 11,5 cm
- 13.0333 13,0 cm
- 13.0335 14,5 cm
- 13.0337 15,5 cm
- 13.0339 16,5 cm
- 13.0341 18,5 cm
- 13.0343 20,0 cm

- 13.0333SC**
- 13.0335SC**

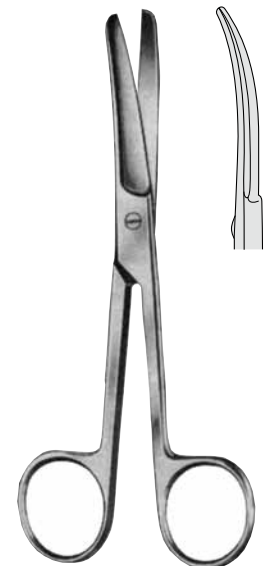

- 13.0351 11,5 cm
- 13.0353 13,0 cm
- 13.0355 14,5 cm
- 13.0357 15,5 cm
- 13.0359 16,5 cm
- 13.0361 18,5 cm
- 13.0363 20,0 cm

- 13.0355SC**
- 13.0363SC**



MAYO

- 13.0400 14,5 cm
- 13.0400SC** 14,5 cm
- 13.0402 15,5 cm
- 13.0402SC** 15,5 cm
- 13.0404 17,0 cm
- 13.0404SC** 17,0 cm
- 13.0406 20,0 cm
- 13.0406SC** 20,0 cm
- 13.0408 23,0 cm
- 13.0408SC** 23,0 cm

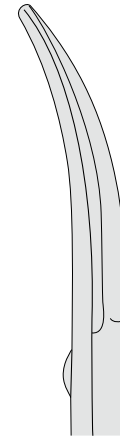

- 13.0401 14,5 cm
- 13.0401SC** 14,5 cm
- 13.0403 15,5 cm
- 13.0403SC** 15,5 cm
- 13.0405 17,0 cm
- 13.0405SC** 17,0 cm
- 13.0407 20,0 cm
- 13.0407SC** 20,0 cm
- 13.0409 23,0 cm
- 13.0409SC** 23,0 cm

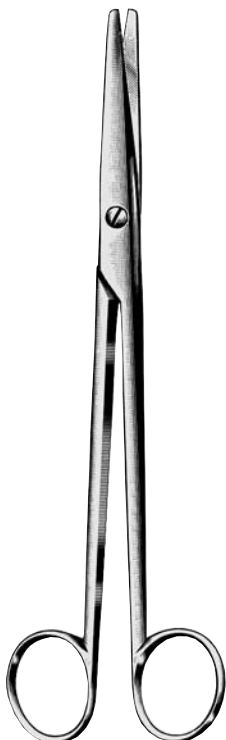

MAYO-STILLE

- 13.0432 15,0 cm
- 13.0432SC** 15,0 cm
- 13.0434 17,0 cm
- 13.0434SC** 17,0 cm
- 13.0436 19,5 cm
- 13.0438 21,0 cm



- 13.0433 15,0 cm
- 13.0433SC** 15,0 cm
- 13.0435 17,0 cm
- 13.0435SC** 17,0 cm
- 13.0437 19,5 cm
- 13.0439 21,0 cm

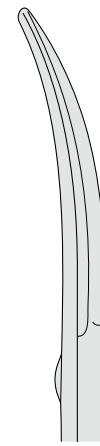

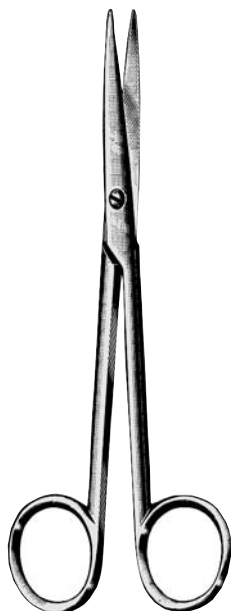

MAYO-LEXER
13.0440 16,5 cm
13.0440SC 16,5 cm

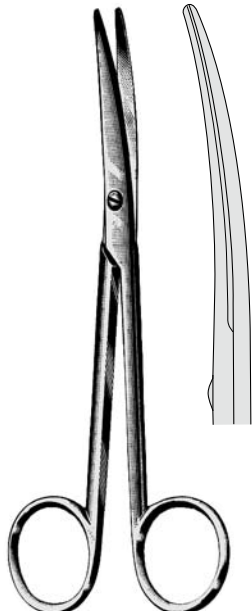

MAYO-LEXER
13.0441 16,5 cm
13.0441SC 16,5 cm

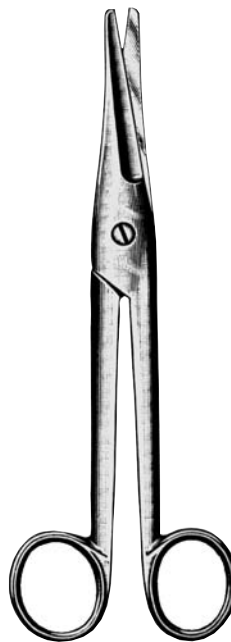

MAYO-NOBLE

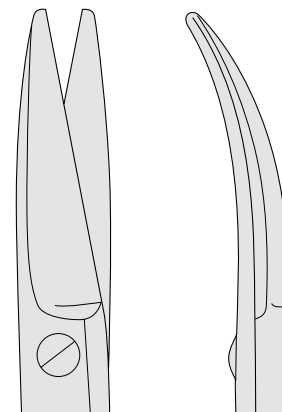

13.0462 17 cm 13.0463 17 cm

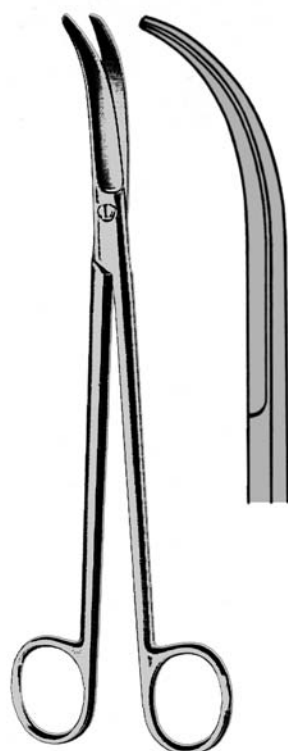

JÖRGENSON
13.0541 23 cm

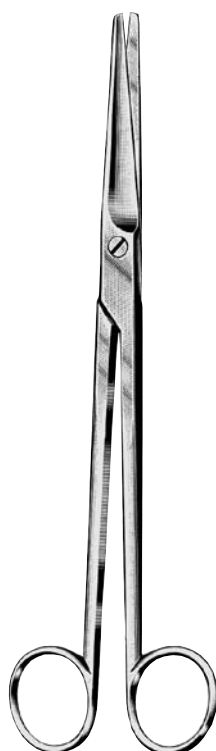

MAYO-HARRINGTON



13.0550 23 cm
13.0554 28 cm
13.0554SC 28 cm



13.0551 23 cm
13.0555 28 cm
13.0555SC 28 cm

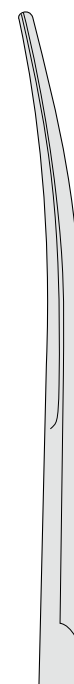



WERTHEIM

- 13.0561 14,5 cm
- 13.0562 19,5 cm
- 13.0563 22,5 cm



THOREK

- 13.0565 19 cm
- 13.0567 23 cm



LEXER-BABY

- 13.0700
10 cm

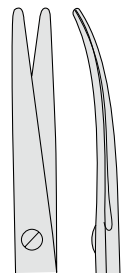

- 10.0701
10 cm

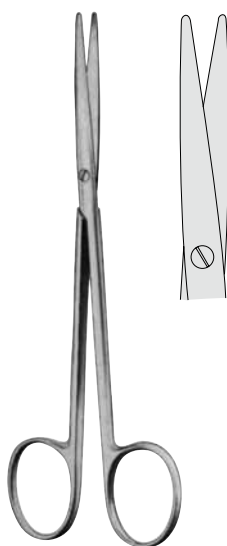

METZENBAUM-BABY

- 13.0594 11,5 cm
- 13.0594SC 11,5 cm
- 13.0596 13,0 cm
- 13.0598 14,5 cm
- 13.0598SC 14,5 cm



METZENBAUM-BABY

- 13.0595 11,5 cm
- 13.0595SC 11,5 cm
- 13.0597 13,0 cm
- 13.0599 14,5 cm
- 13.0599SC 14,5 cm



stumpf - stumpf
blunt - blunt
mousses - mousses
romo - romo
smusso - smusso



spitz - stumpf
sharp - blunt
pointu - mousses
agudo - romo
appuntato - smusso



METZENBAUM

13.0602	18,0 cm	13.0602SC
13.0604	20,0 cm	13.0604SC
13.0606	23,0 cm	13.0606SC
13.0608	25,0 cm	13.0608SC
13.0610	28,0 cm	13.0610SC
13.0612	30,0 cm	13.0612SC

METZENBAUM

13.0603	18,0 cm	13.0603SC
13.0605	20,0 cm	13.0605SC
13.0607	23,0 cm	13.0607SC
13.0609	25,0 cm	13.0609SC
13.0611	28,0 cm	13.0611SC
13.0613	30,0 cm	13.0613SC

METZENBAUM

13.0622	18,0 cm
13.0624	20,0 cm
13.0626	23,0 cm
13.0628	25,0 cm
13.0630	28,0 cm

METZENBAUM

13.0623	18,0 cm
13.0625	20,0 cm
13.0627	23,0 cm
13.0629	25,0 cm
13.0631	28,0 cm



spitz - spitz
sharp - sharp
pointu - pointu
agudo - agudo
appuntato - appuntato

METZENBAUM

13.0642	18,0 cm	
13.0644	20,0 cm	13.0644SC
13.0646	23,0 cm	
13.0648	25,0 cm	
13.0650	28,0 cm	13.0650SC

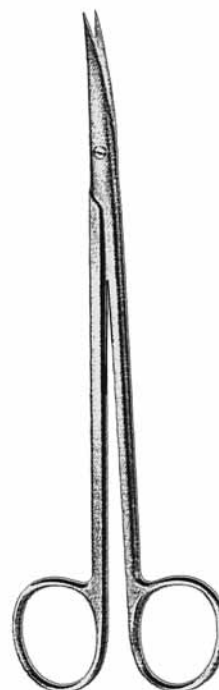

METZENBAUM

13.0643	18,0 cm	
13.0645	20,0 cm	13.0645SC
13.0647	23,0 cm	
13.0649	25,0 cm	
13.0651	28,0 cm	13.0651SC

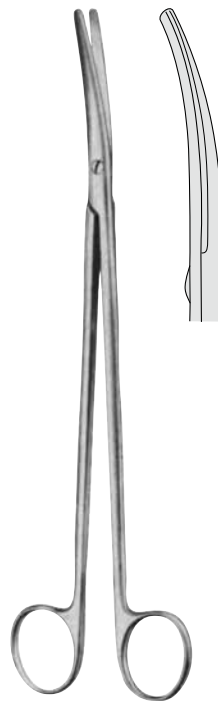
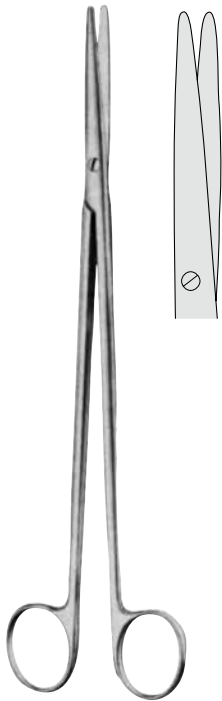

METZENBAUM-FINO

- 13.0660 14,5 cm **13.0660SC**
- 13.0662 18,0 cm **13.0662SC**
- 13.0664 20,0 cm **13.0664SC**
- 13.0666 23,0 cm **13.0666SC**

METZENBAUM-FINO

- 13.0661 14,5 cm **13.0661SC**
- 13.0663 18,0 cm **13.0663SC**
- 13.0665 20,0 cm **13.0665SC**
- 13.0667 23,0 cm **13.0667SC**

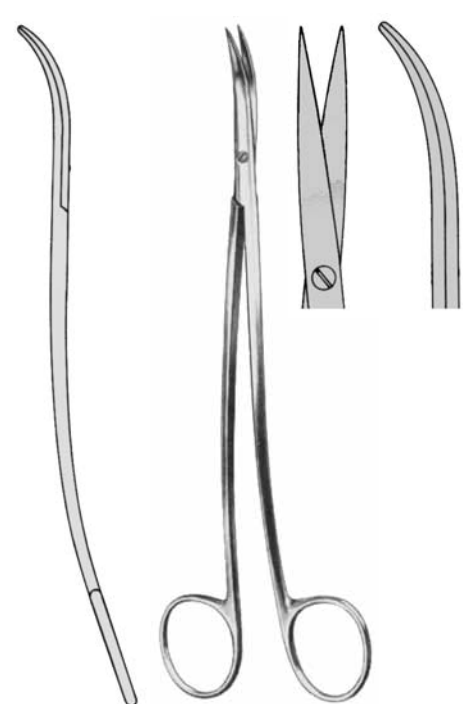
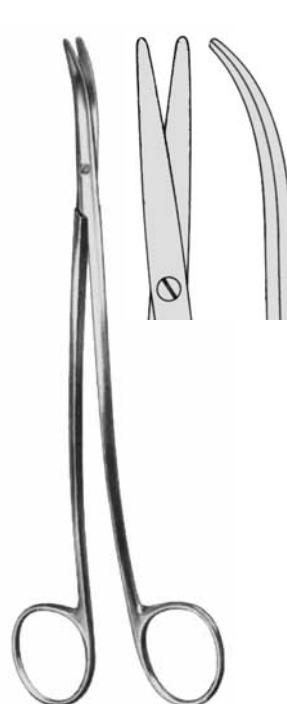
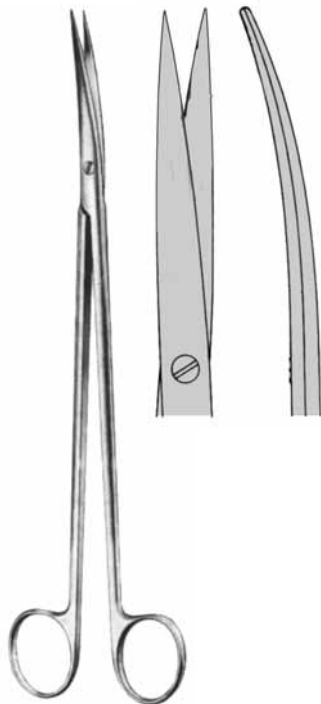
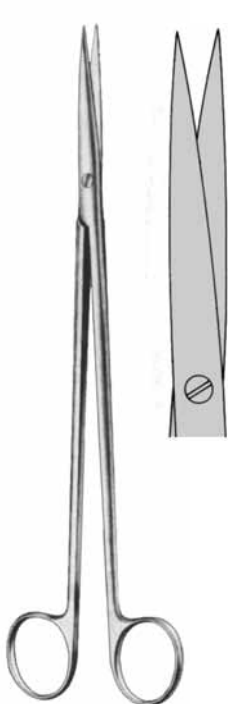

METZENBAUM-FINO

- 13.0670 14,5 cm
- 13.0672 18,0 cm
- 13.0674 20,0 cm
- 13.0676 23,0 cm

METZENBAUM-FINO

- 13.0671 14,5 cm
- 13.0673 18,0 cm
- 13.0675 20,0 cm
- 13.0677 23,0 cm

METZENBAUM-FINO

- 13.0683 18,0 cm
- 13.0685 20,0 cm
- 13.0687 23,0 cm

METZENBAUM-FINO

- 13.0693 18,0 cm
- 13.0695 20,0 cm
- 13.0697 23,0 cm



METZENBAUM
13.0614
36 cm



METZENBAUM
13.0615
36 cm

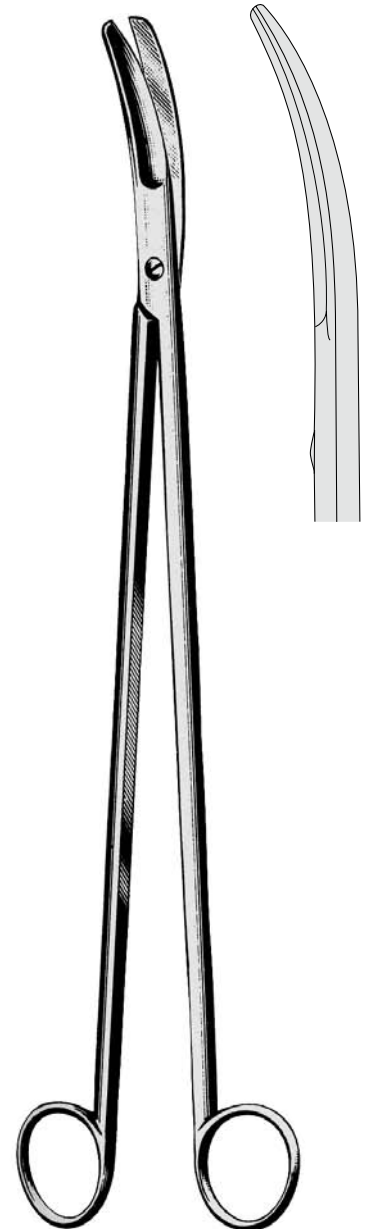

CRAFOORD
13.1083
31,5 cm



MAYO
13.5208
36 cm

MAYO
13.5209
36 cm

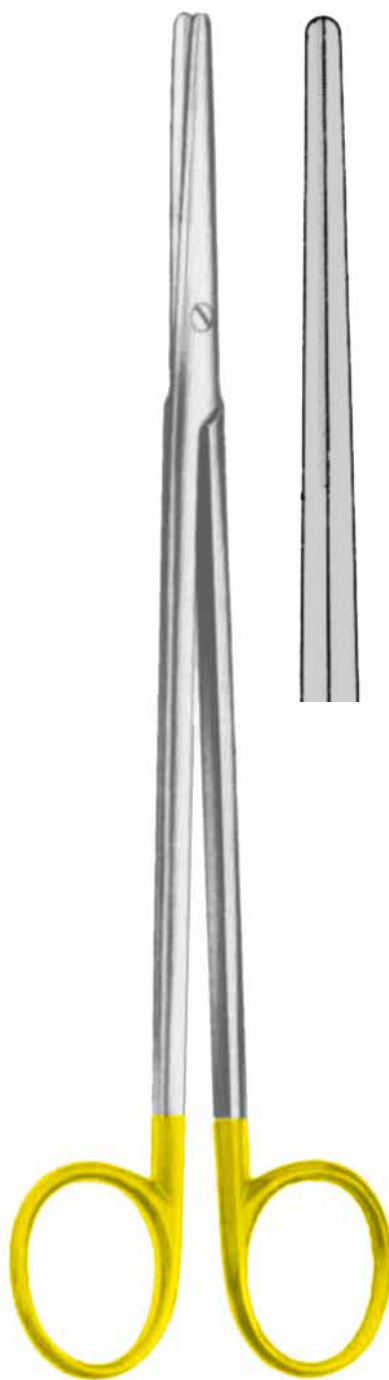

METZENBAUM
13.5382
36 cm

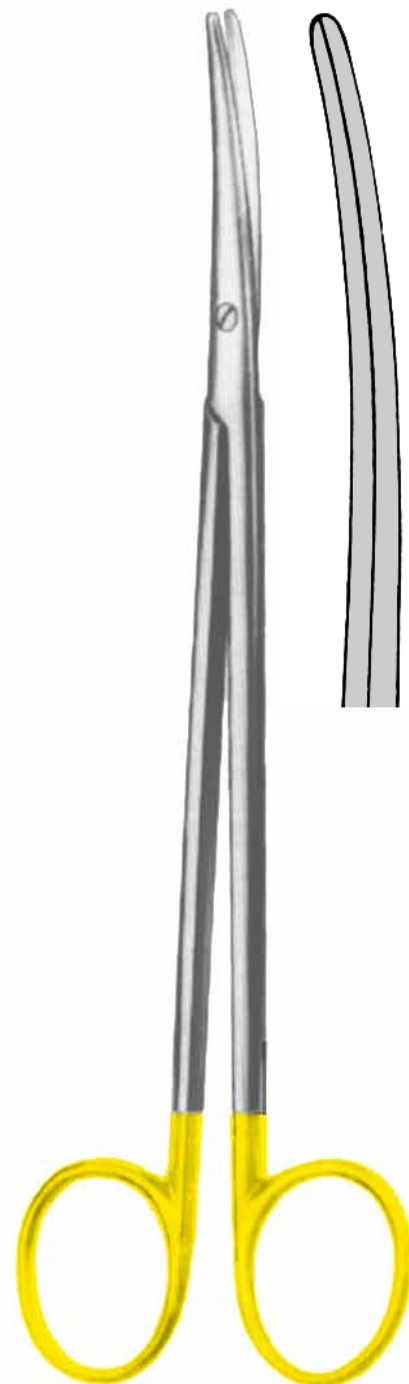

METZENBAUM
13.5383
36 cm

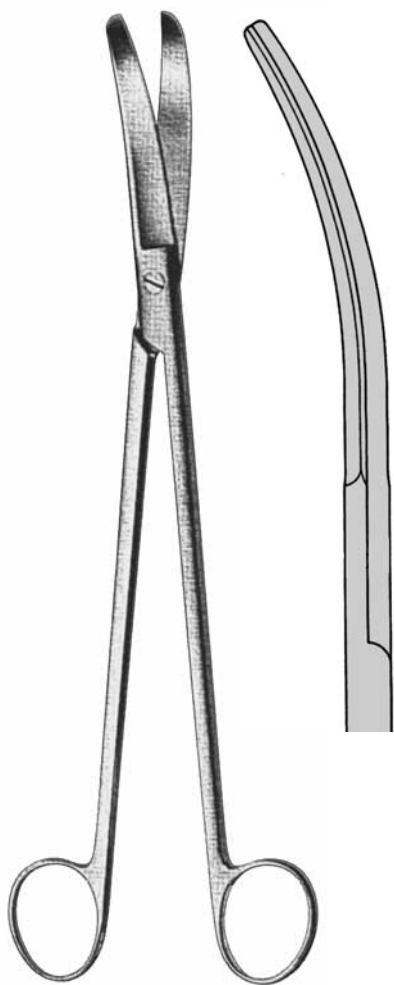

LLOYD-DAVIS
13.2183 27 cm

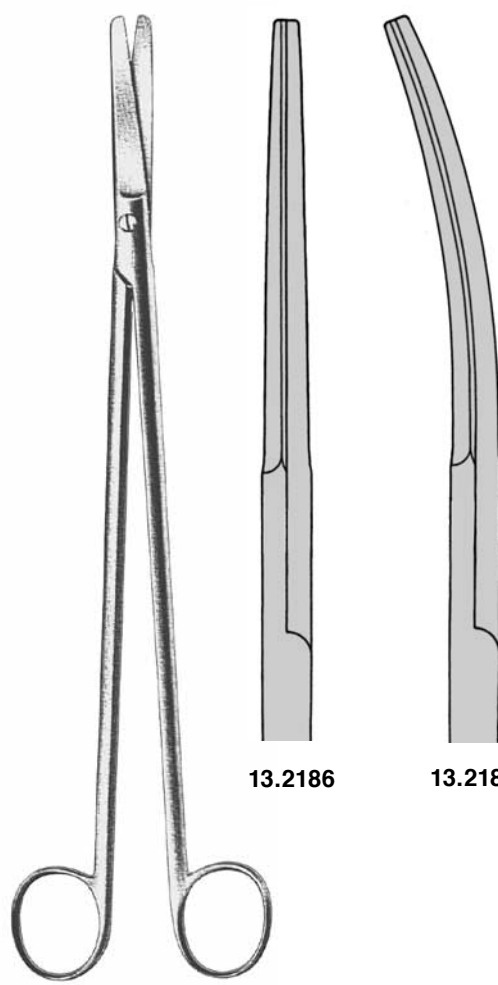

STELZNER
27 cm

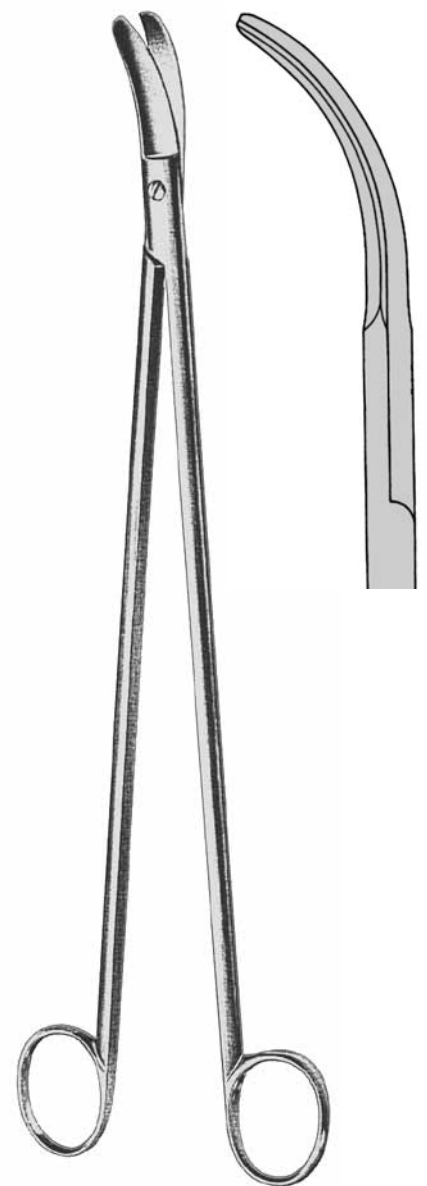

13.2189 32 cm

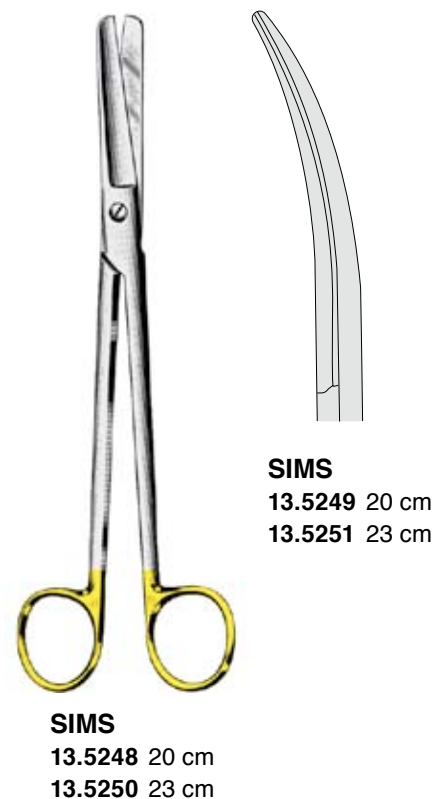
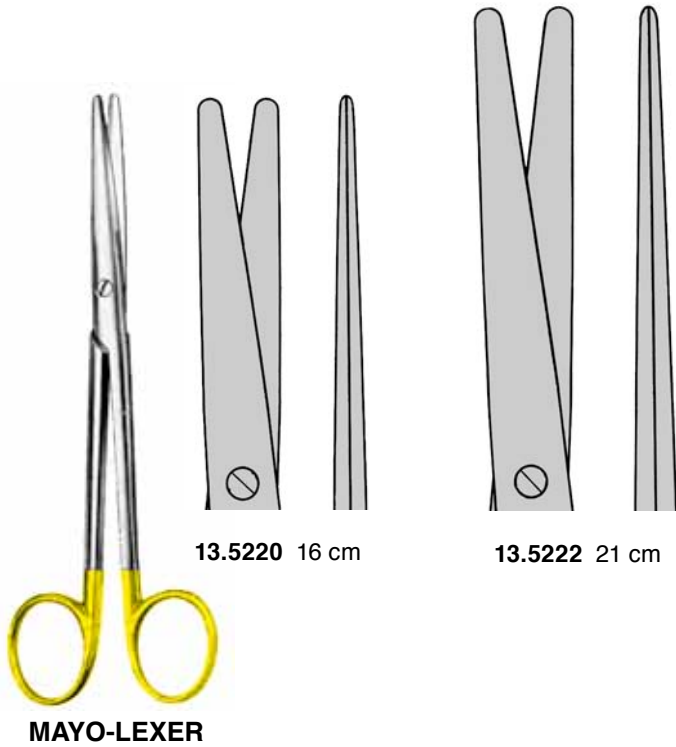



PARAMETRIUM

23 cm **13.5252**
 26 cm
 30 cm

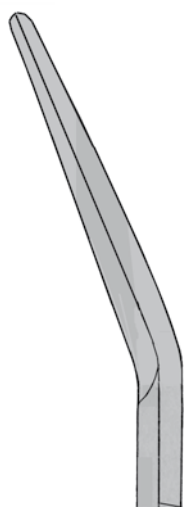

13.5255
13.5265
13.5275



13.5257
13.5267
13.5277

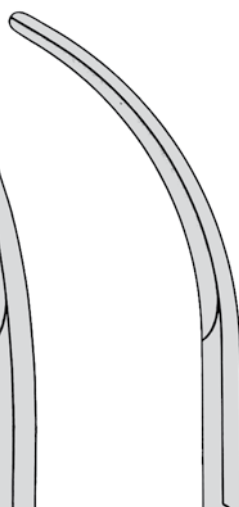

13.5259
13.5269
13.5279



BLESSING

13.5281
 30 cm

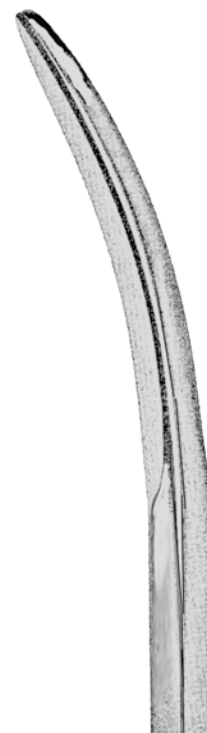

Schere für Rektumchirurgie
 Scissors for rectal surgery
 Ciseaux pour chirurgie rectale
 Tijera para la cirugía del recto
 Forbici per la chirurgia rettale



METZENBAUM

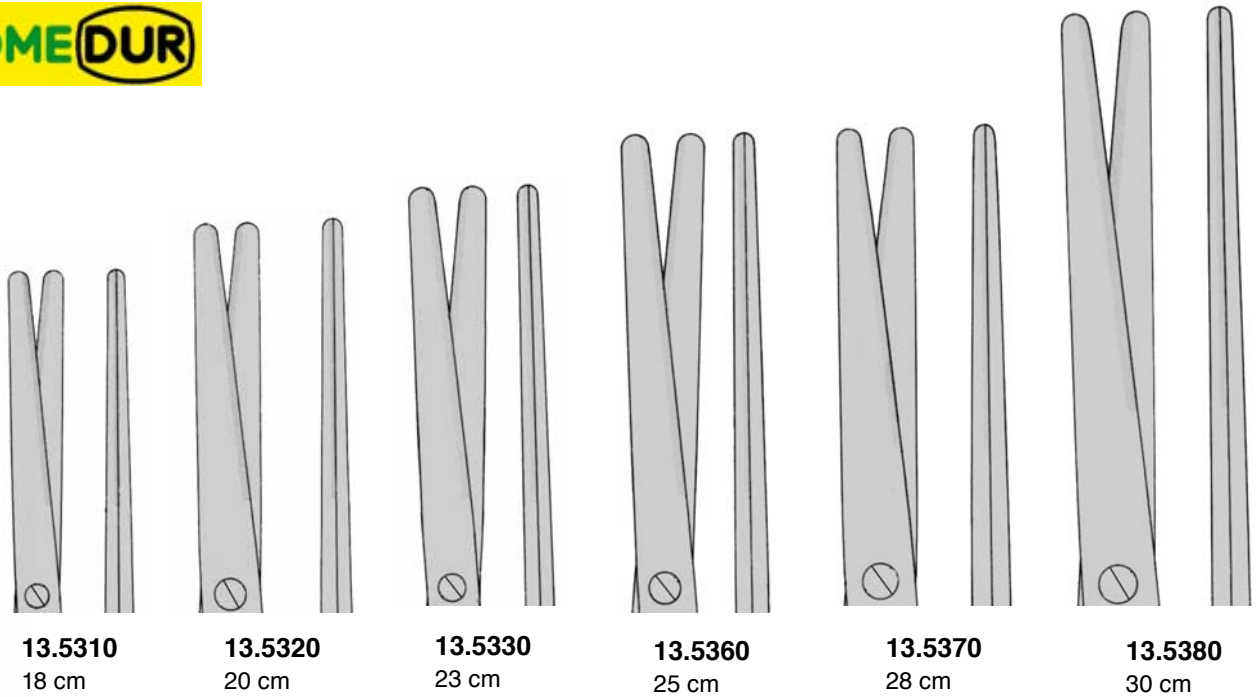

13.5310
18 cm

13.5320
20 cm

13.5330
23 cm

13.5360
25 cm

13.5370
28 cm

13.5380
30 cm



METZENBAUM

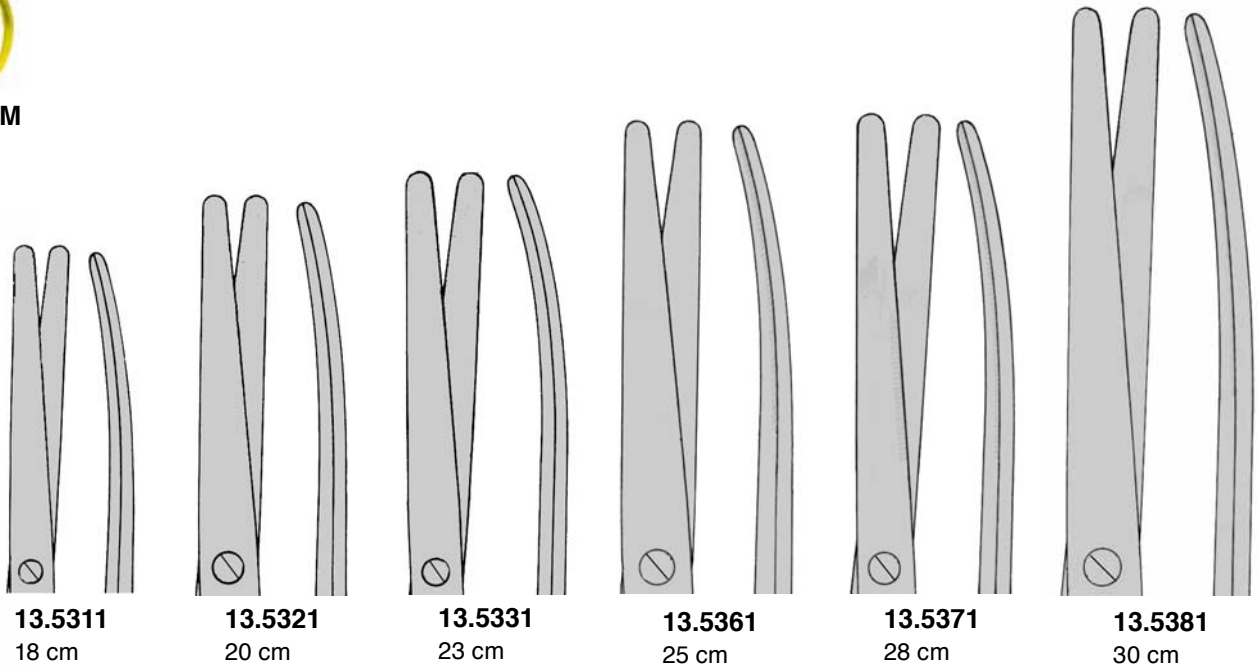

13.5311
18 cm

13.5321
20 cm

13.5331
23 cm

13.5361
25 cm

13.5371
28 cm

13.5381
30 cm

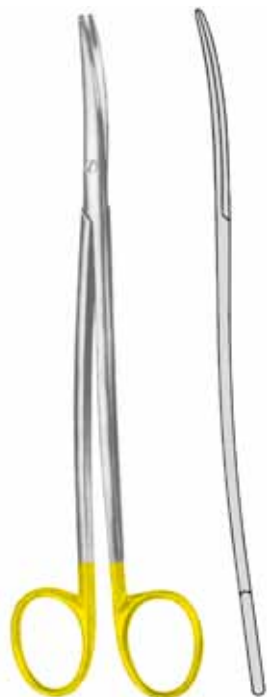

METZENBAUM-FINO

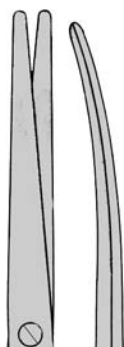

13.5313
18 cm

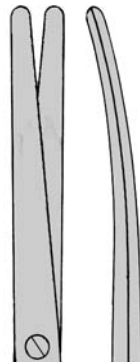

13.5323
20 cm

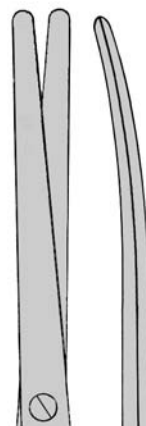

13.5333
23 cm

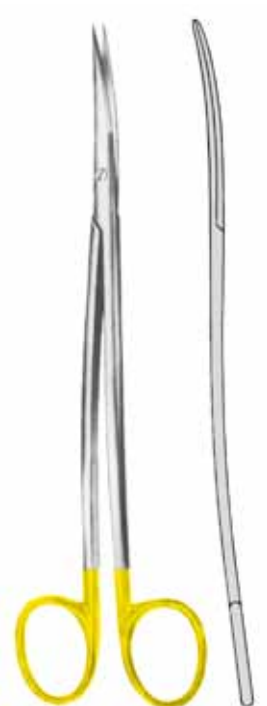

METZENBAUM-FINO

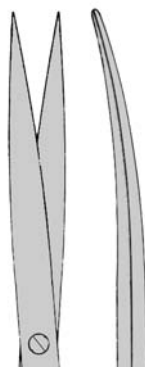

13.5317
18 cm

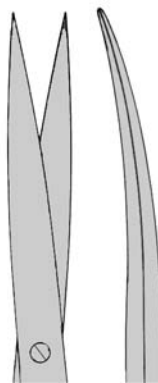

13.5327
20 cm



13.5337
23 cm

„BiTech“ Bipolare Scheren
„BiTech“ Bipolar Scissors
„BiTech“ Ciseaux bipolaires
„BiTech“ Tijeras bipolares
„BiTech“ Forbici bipolari

MICRO



13.8003
13 cm

13.8005
14 cm

13.8007
18 cm

„BiTech“ Bipolare Scheren
„BiTech“ Bipolar Scissors
„BiTech“ Ciseaux bipolaires
„BiTech“ Tijeras bipolares
„BiTech“ Forbici bipolari

STANDARD



13.8023
18 cm

13.8025
21 cm

13.8027
23 cm

13.8029
28 cm

„BiTech“ Bipolare Scheren
„BiTech“ Bipolar Scissors
„BiTech“ Ciseaux bipolaires
„BiTech“ Tijeras bipolares
„BiTech“ Forbici bipolari

DELICATE



13.8043
18 cm

13.8045
21 cm

13.8047
23 cm

13.8049
28 cm

bipolare Scheren-Klemmen
Bipolar Clamp-Scissors
Clamp-Ciseaux bipolaires
Pinzas-Tijeras bipolares
Forbici-Pinze bipolarari



13.8304
14 cm

13.8305
14 cm

13.8310
19 cm

13.8311
19 cm

Kabel für "BiTech" Bipolare Scheren
Cables for "BiTech" Bipolar Scissors
Câbles pour "BiTech" Ciseaux bipolaires
Cables para Tijeras bipolares
Cavi per "BiTech" Forbici bipolari
13.8003 - 13.8049



Kabel für bipolare Scheren-Klemmen
Cables for Bipolar Clamp-Scissors
Câbles pour Clamp-Ciseaux bipolaires
Cables para Pinzas-Tijeras bipolares
Cavi per Forbici-Pinze bipolari
13.8304 - 13.8311



Stecker Generatorseitig
Plug, Generator side:
Connecteur, côté générateur
Clavia, lado del generador
Spina, lato generatore

"2-Banana"



3 m

13.8100

13.8400

ERBE



3 m

13.8110

13.8410

MARTIN,
BERCHTOLD;
AESCULAP GK 55
GK 60



3 m

13.8120

13.8420

VALLEYLAB, EMC,
LAMIDEY



3 m

13.8130

13.8430

PINZETTEN
FORCEPS
PINCES
PINZAS
PINZE

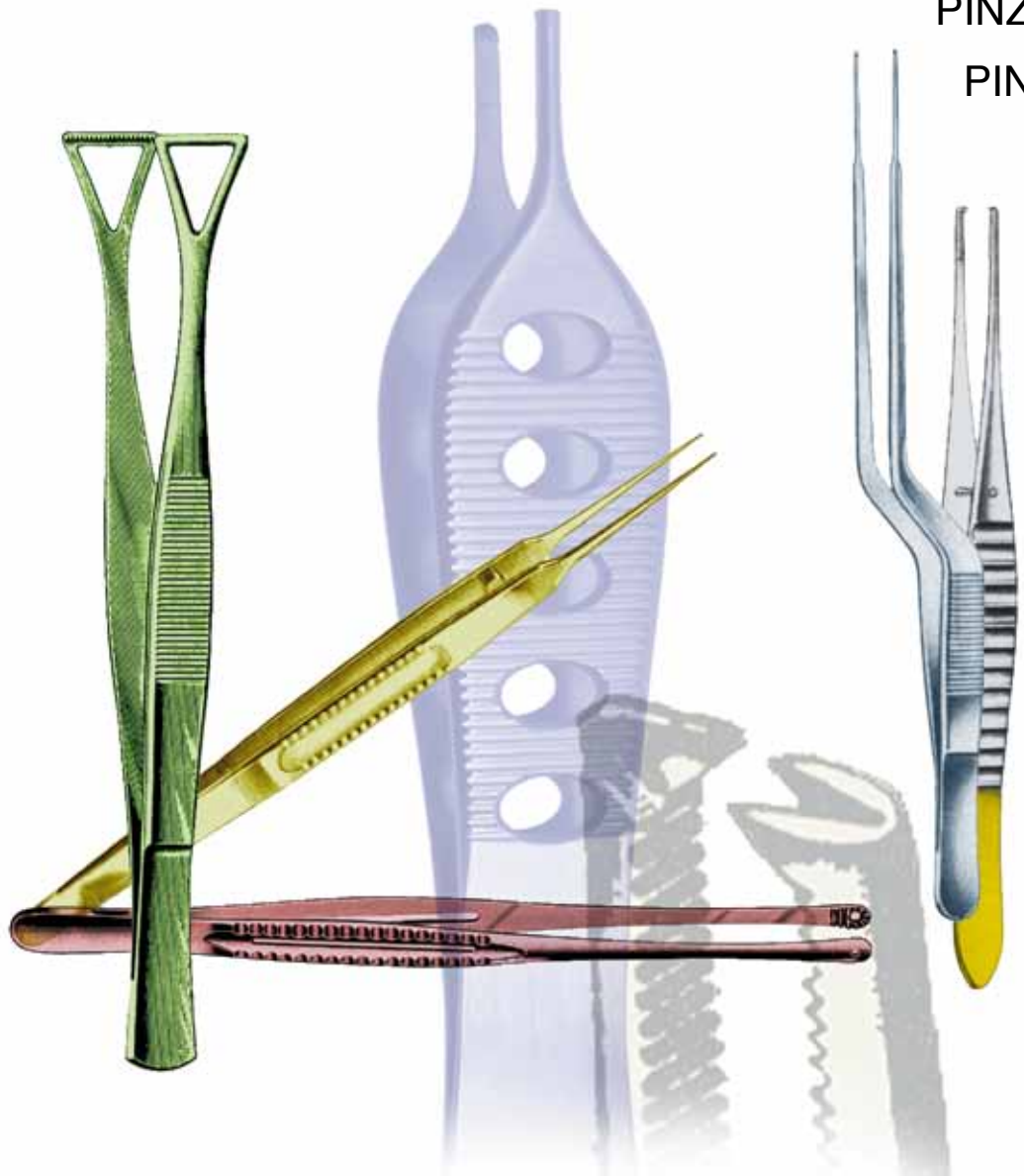



ADSON
 14.0026 12 cm



ADSON-MICRO
 14.0028 12 cm

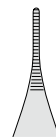

ADSON-MICRO
 14.0030 12 cm
 14.0032 15 cm



ADSON
 14.0040 12 cm
 14.0042 15 cm

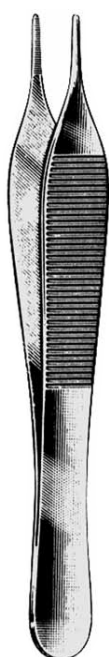

12 cm

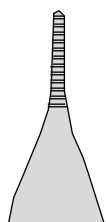

EWALD
 14.0049

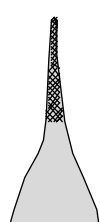

ADSON
 "Criss-Cross"
 14.0050

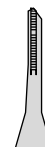

ADSON-DEBAKEY
 14.0546 12,5 cm
 14.0547 15,0 cm



ADSON
 14.0044 18 cm



JEFFERSON
 14.0056 18 cm



SEMKEN



14.0060 12 cm
14.0062 15 cm



14.0061
14.0063



McINDOE



14.0070 15 cm



DRESSING-FINO

14.0100	10,5 cm
14.0101	11,5 cm
14.0102	13,0 cm
14.0103	14,5 cm
14.0104	15,0 cm
14.0105	16,0 cm
14.0107	18,0 cm
14.0108	20,0 cm
14.0109	25,0 cm



DRESSING-FINO

14.0110	10,5 cm
14.0111	11,5 cm
14.0112	13,0 cm
14.0113	14,5 cm
14.0114	15,0 cm
14.0115	16,0 cm
14.0116	18,0 cm
14.0117	20,0 cm
14.0118	25,0 cm
14.0119	30,0 cm



DRESSING

14.0120	10,5 cm
14.0121	11,5 cm
14.0122	13,0 cm
14.0123	14,5 cm
14.0124	15,0 cm
14.0125	16,0 cm
14.0127	18,0 cm
14.0128	20,0 cm
14.0129	25,0 cm
14.0130	30,0 cm



DRESSING

14.0151	11,5 cm
14.0152	13,0 cm
14.0153	14,5 cm
14.0154	15,0 cm
14.0155	16,0 cm
14.0157	18,0 cm
14.0158	20,0 cm



DRESSING-USA

14.0181	11,5 cm
14.0182	13,0 cm
14.0183	14,5 cm
14.0184	15,5 cm
14.0187	18,0 cm
14.0188	20,0 cm
14.0189	25,0 cm



STILLE

14.0202	13 cm
14.0204	15 cm
14.0207	17 cm
14.0220	20 cm



BLANK

14.0142	13,0 cm
14.0143	14,5 cm
14.0144	16,0 cm



BROPHY

14.0300	20 cm
---------	-------



BROPHY

14.0301	20 cm
---------	-------



DUEHRSSSEN
14.0330 20 cm

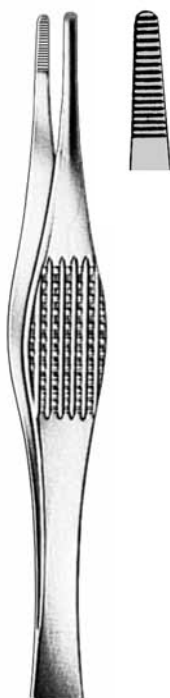

RAMSEY
14.0340 18 cm

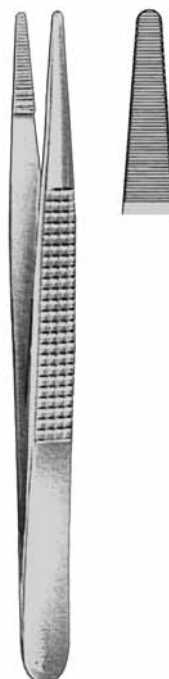

BONNEY
14.0390 18 cm



POTTS-SMITH
14.0350 18 cm
14.0352 21 cm
14.0354 25 cm

Pinzetten / Dressing- and Tissue Forceps / Pincés à dissection / Pinzas de disección / Pinze per dissezione



DRESSING
14.0132
36 cm

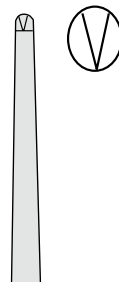
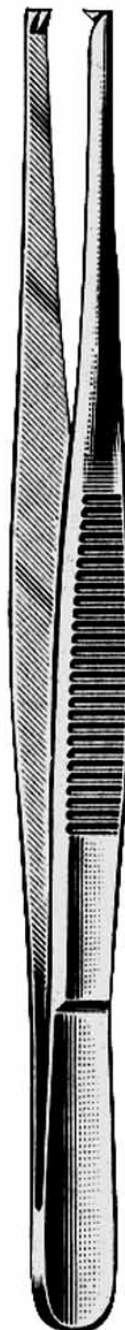

TISSUE
14.0632
36 cm
1x2

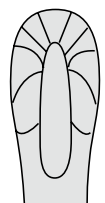

RUSSIAN
14.0938
36 cm

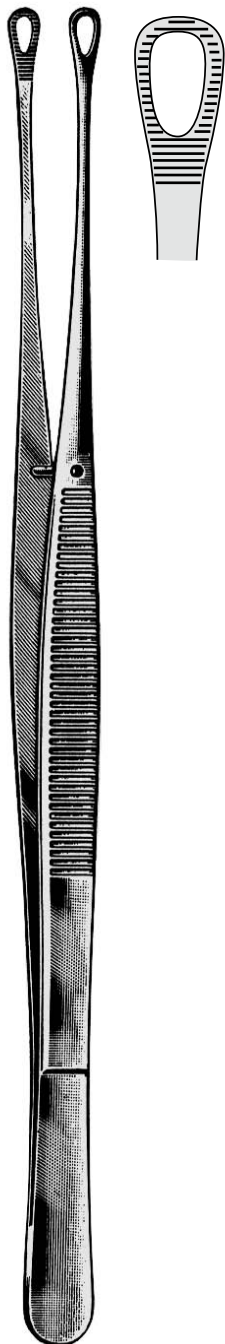

SINGLEY
14.0958
36 cm



DEBAKEY
14.1018
36 cm/2 mm



ADSON
 14.0526
 12 cm 1x2



ADSON-SELECT-MICRO
 14.0527
 12 cm 1x2



ADSON-MICRO
 14.0528
 12 cm 1x2



ADSON-MICRO
 14.0530 12 cm
 14.0532 15 cm

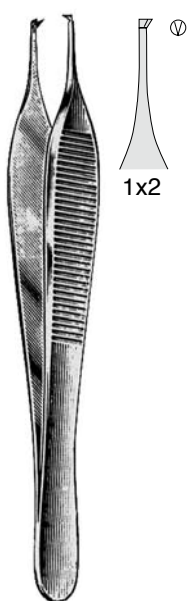

ADSON
 14.0540 12 cm
 14.0542 15 cm

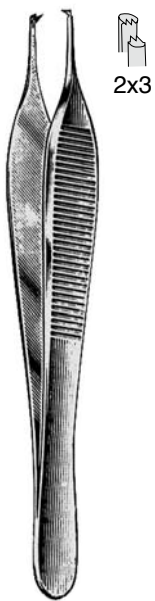

ADSON
 14.0541 12 cm 2x3

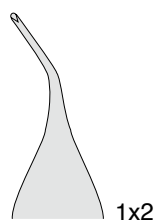

ADSON
 14.0543 12 cm 45° 1x2
 14.0545 15 cm 45° 1x2

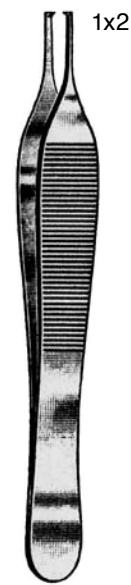

EWALD
 14.0549 12 cm



ADSON-GRAEFE
 14.0548 12 cm

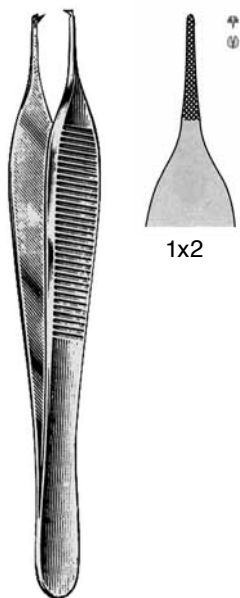

ADSON
 "Criss-Cross"
 14.0550 12 cm



ADSON
 14.0554 18 cm

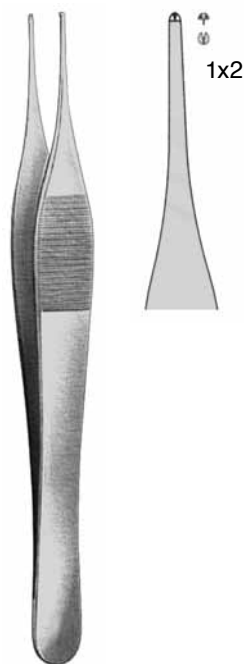

JEFFERSON
 14.0556 18 cm



SEMKEN
 14.0560 12 cm
 14.0562 15 cm

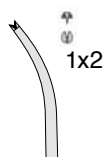

SEMKEN
 14.0561 12 cm
 14.0563 15 cm

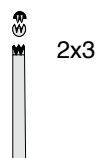

SEMKEN
 14.0566 12 cm



GILLIES
 14.0570 15 cm



TISSUE-FINO

14.0600	10,5 cm	1x2
14.0601	11,5 cm	1x2
14.0602	13,0 cm	1x2
14.0603	14,5 cm	1x2
14.0604	15,0 cm	1x2
14.0605	16,0 cm	1x2
14.0607	18,0 cm	1x2
14.0608	20,0 cm	1x2
14.0609	25,0 cm	1x2

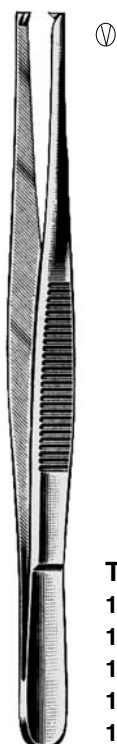

TISSUE

14.0620	10,5 cm	1x2
14.0621	11,5 cm	1x2
14.0622	13,0 cm	1x2
14.0623	14,5 cm	1x2
14.0624	15,0 cm	1x2
14.0625	16,0 cm	1x2
14.0627	18,0 cm	1x2
14.0628	20,0 cm	1x2
14.0629	25,0 cm	1x2
14.0630	30,0 cm	1x2



TISSUE

14.0653	14,0 cm	1x2
14.0657	18,0 cm	1x2



TISSUE-USA

14.0681	12,0 cm	1x2
14.0682	13,0 cm	1x2
14.0683	14,5 cm	1x2
14.0684	15,5 cm	1x2
14.0687	18,0 cm	1x2
14.0688	21,0 cm	1x2
14.0689	25,0 cm	1x2



TISSUE

14.0701	11,5 cm	2x3
14.0702	13,0 cm	2x3
14.0703	14,5 cm	2x3
14.0704	15,0 cm	2x3
14.0705	16,0 cm	2x3
14.0707	18,0 cm	2x3
14.0708	20,0 cm	2x3
14.0709	25,0 cm	2x3

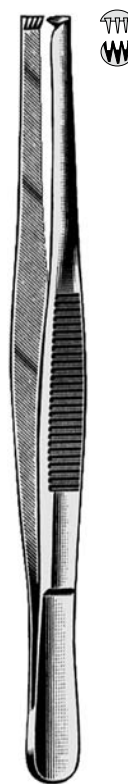

TISSUE

14.0722	13,0 cm	3x4
14.0723	14,5 cm	3x4
14.0724	15,0 cm	3x4
14.0725	16,0 cm	3x4
14.0727	18,0 cm	3x4
14.0728	20,0 cm	3x4

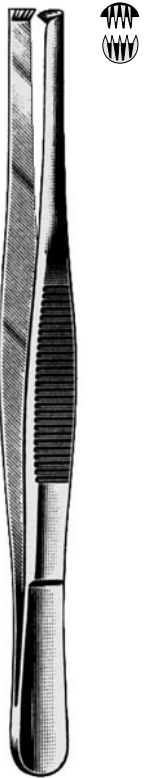

TISSUE
 14.0732 13,0 cm 4x5
 14.0733 14,5 cm 4x5
 14.0734 15,0 cm 4x5
 14.0735 16,0 cm 4x5

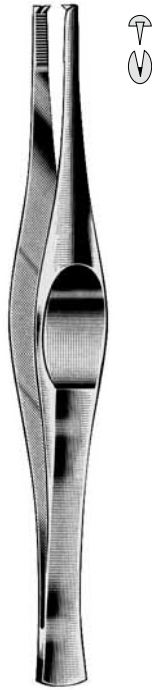

FERRIS-SMITH
 14.0790 18 cm 1x2

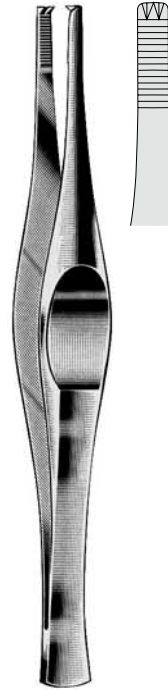

FERRIS-SMITH
 14.0792 18 cm 2x3

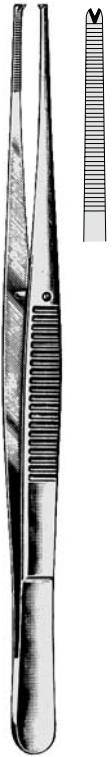

BROPHY
 14.0800 20 cm 1x2



BROPHY
 14.0801 20 cm 1x2



GERALD
 14.0820 18 cm 1x2



GERALD
 14.0821 18 cm 1x2



GERALD
 14.0825 18 cm 1x2



DUEHRSEN
14.0830 20 cm 1x2

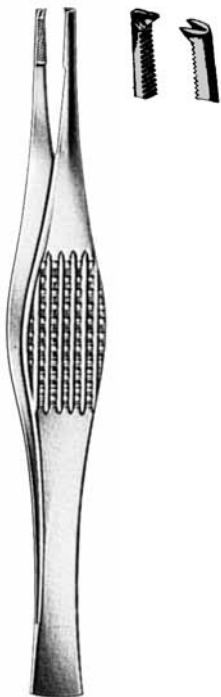

RAMSEY
14.0840 18 cm 1x2

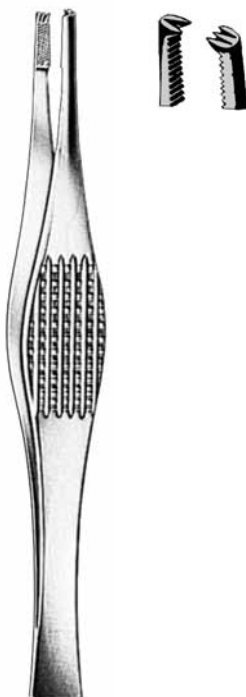

RAMSEY
14.0842 18 cm 2x3



POTTS-SMITH
14.0850 18 cm 1x2
14.0852 21 cm 1x2
14.0854 25 cm 1x2



POTTS-SMITH
14.0851 18 cm 1x2
14.0853 21 cm 1x2
14.0855 25 cm 1x2



TAYLOR
14.0860 18 cm



TAYLOR
14.0861 18 cm

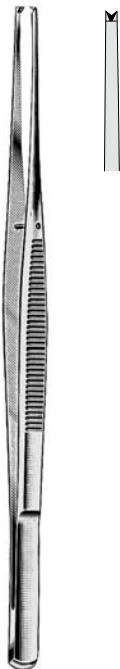

TAYLOR-CUSHING
14.0862 18 cm



TAYLOR-CUSHING
14.0865 18 cm



ALDERKREUZ
 14.0866 15 cm 2x3
 14.0867 20 cm 2x3

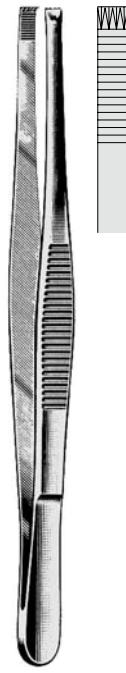

ALDERKREUZ
 14.0868 15 cm 4x5
 14.0869 20 cm 4x5

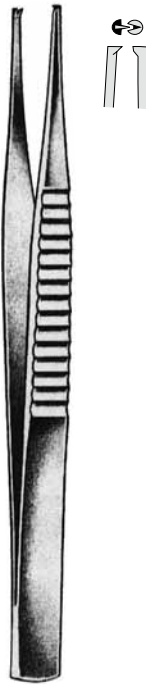

TREVES
 14.0870 13 cm 1x2
 14.0872 15 cm 1x2

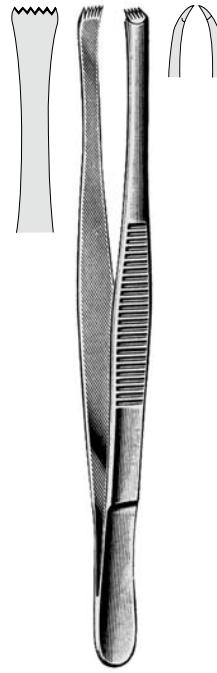

LERCHE
 14.0880 15 cm 5x6



STONE
 14.0885 15 cm 4x5

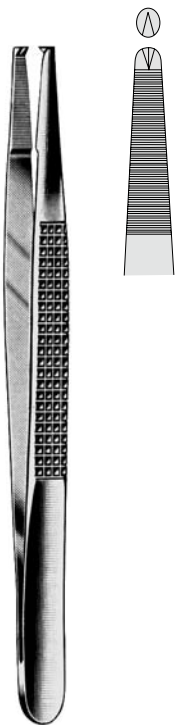

BONNEY
 14.0890
 18 cm 1x2



BONNEY
 14.0892
 18 cm 2x3



NELSON
 14.0895 15 cm
 14.0896 20 cm
 14.0897 23 cm



ADSON-BROWN
 14.0900 12 cm 9x9

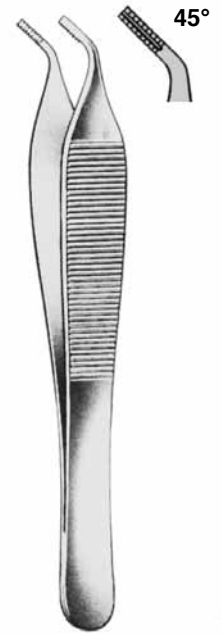

ADSON-BROWN
 14.0904 12 cm 9x9



BROWN
 14.0910 15 cm
 14.0912 20 cm
 14.0914 25 cm



LANE
 14.0920 14,5 cm 1x2
 14.0922 20,0 cm 1x2



LANE
 14.0925 14,5 cm 2x3
 14.0927 20,0 cm 2x3



RUSSIAN
 14.0930 15 cm
 14.0932 20 cm
 14.0934 25 cm

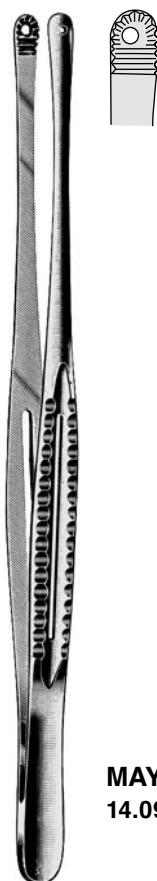

MAYO-RUSSIAN
 14.0940 23 cm



WANGENSTEEN
 14.0948 23 cm



SINGLEY (TUTTLE)
 14.0950 15 cm
 14.0952 18 cm
 14.0954 23 cm

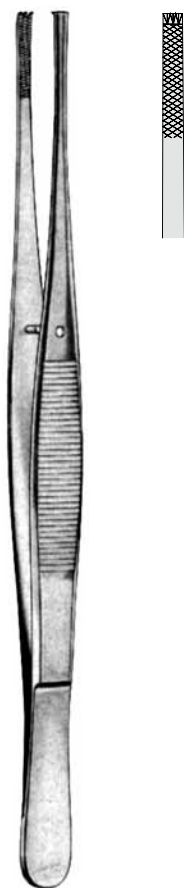

STILLE-BARRAYA

14.0960 18 cm
14.0962 20 cm
14.0964 25 cm



WAUGH

14.0968 15 cm
14.0970 20 cm



DURANTE



14.0980
14,5 cm



14.0982
16 cm



14.0984
20 cm



DENIS-BROWN
14.0988 18 cm

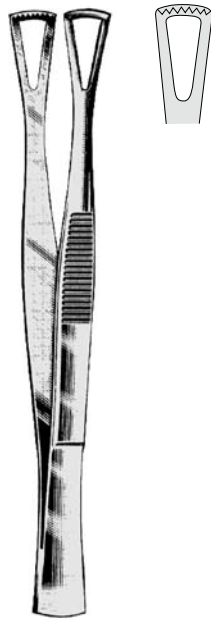

DUVAL
14.0990 14,5 cm

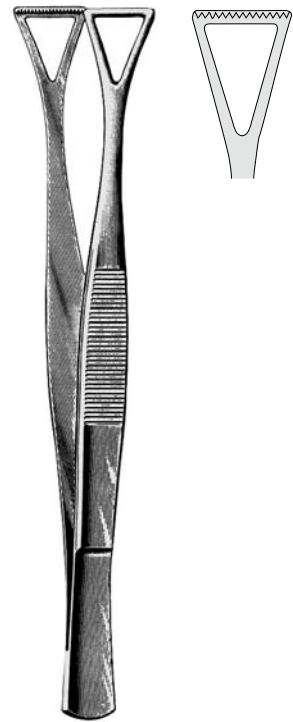

COLLIN-DUVAL
14.0994 20 cm, 14 mm
14.0996 20 cm, 18 mm
14.0998 20 cm, 27 mm

TITANIUM



DEBAKEY

- 14.1000** 15 cm / 1,5 mm
- 14.1002** 20 cm / 1,5 mm
- 14.1004** 24 cm / 1,5 mm
- 14.1006** 30 cm / 1,5 mm



DEBAKEY

- 14.1007T** 16 cm / 1,5 mm
- 14.1008T** 20 cm / 1,5 mm
- 14.1009T** 24 cm / 1,5 mm



DEBAKEY

- 14.1010** 15 cm/2 mm
- 14.1010T** 15 cm/2 mm
- 14.1012** 20 cm/2 mm
- 14.1012T** 20 cm/2 mm
- 14.1014** 24 cm/2 mm
- 14.1014T** 24 cm/2 mm
- 14.1016** 30 cm/2 mm
- 14.1016T** 30 cm/2 mm



DEBAKEY

- 14.1017T** 16 cm/1,8 mm
- 14.1018T** 20 cm/1,8 mm
- 14.1019T** 24 cm/1,8 mm



DEBAKEY

- 14.1021** 16 cm/2 mm
- 14.1021T** 16 cm/2 mm
- 14.1023** 20 cm/2 mm
- 14.1023T** 20 cm/2 mm
- 14.1025** 24 cm/2 mm
- 14.1025T** 24 cm/2 mm
- 14.1027** 30 cm/2 mm
- 14.1027T** 30 cm/2 mm



DEBAKEY

- 14.1030** 16 cm/2,7 mm
- 14.1030T** 16 cm/2,7 mm
- 14.1032** 20 cm/2,7 mm
- 14.1032T** 20 cm/2,7 mm
- 14.1034** 24 cm/2,7 mm
- 14.1034T** 24 cm/2,7 mm
- 14.1036** 30 cm/2,7 mm
- 14.1036T** 30 cm/2,7 mm

TITANIUM



DEBAKEY

- 14.1040 15 cm/3,5 mm
- 14.1040T 15 cm/3,5 mm
- 14.1042 20 cm/3,5 mm
- 14.1042T 20 cm/3,5 mm
- 14.1044 24 cm/3,5 mm
- 14.1044T 24 cm/3,5 mm
- 14.1046 30 cm/3,5 mm
- 14.1046T 30 cm/3,5 mm



COOLEY

- 14.1050 15 cm/2 mm
- 14.1050T 15 cm/2 mm
- 14.1052 20 cm/2 mm
- 14.1052T 20 cm/2 mm
- 14.1054 24 cm/2 mm
- 14.1054T 24 cm/2 mm

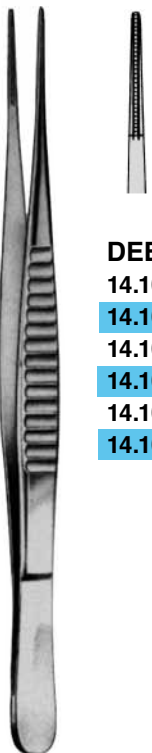

DEBAKEY

- 14.1060 15 cm /1 mm
- 14.1060T 15 cm /1 mm
- 14.1062 20 cm/1 mm
- 14.1062T 20 cm/1 mm
- 14.1064 24 cm/1 mm
- 14.1064T 24 cm/1 mm

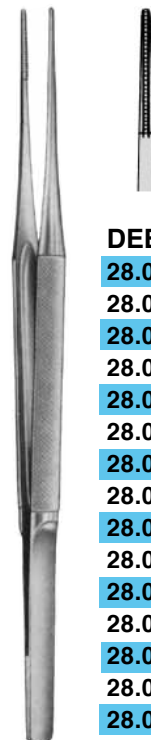

DEBAKEY

- 28.0320T 15 cm /1,2 mm
- 28.0320S 15 cm /1,2 mm
- 28.0322T 18 cm /1,2 mm
- 28.0322S 18 cm /1,2 mm
- 28.0324T 21 cm /1,2 mm
- 28.0324S 21 cm /1,2 mm
- 28.0326T 23 cm /1,2 mm
- 28.0326S 23 cm /1,2 mm
- 28.0330T 15 cm /2,0 mm
- 28.0330S 15 cm /2,0 mm
- 28.0332T 18 cm /2,0 mm
- 28.0332S 18 cm /2,0 mm
- 28.0334T 21 cm /2,0 mm
- 28.0334S 21 cm /2,0 mm
- 28.0336T 23 cm /2,0 mm
- 28.0336S 23 cm /2,0 mm



GLASSMANN



14.1070
15 cm 4 mm



14.1072
24 cm 8 mm



14.2001 12 cm
 glatt / smooth
 lisse / lisa / liscio



ADSON

14.2000 12 cm
 14.2002 15 cm

ADSON

14.2005 12 cm 1x2
 14.2007 15 cm 1x2

SEMKEN

14.2010 15 cm

CUSHING

14.2020 18 cm

CUSHING

14.2021 18 cm

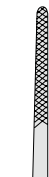

1.8 mm

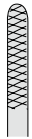

2.7 mm

CUSHING

14.2023 19 cm

POTTS-SMITH

14.2049 15 cm
 14.2050 18 cm
 14.2052 21 cm
 14.2054 25 cm

WANGENSTEEN

14.2070 15 cm
 14.2072 23 cm
 14.2074 25 cm

DRESSING

14.2103 14,5 cm
 14.2105 16,0 cm
 14.2107 18,0 cm
 14.2108 20,0 cm
 14.2109 25,0 cm
 14.2110 30,0 cm

DRESSING

14.2122 13,0 cm
 14.2123 14,5 cm
 14.2125 16,0 cm
 14.2127 18,0 cm
 14.2128 20,0 cm
 14.2129 25,0 cm
 14.2130 30,0 cm



MC INDOE
14.2170 15 cm



DEBAKEY
14.2200
15 cm / 1,5 mm
14.2202
19 cm / 1,5 mm
14.2204
24 cm / 1,5 mm



DEBAKEY
14.2210
15 cm / 2 mm
14.2212
19 cm / 2 mm
14.2214
24 cm / 2 mm

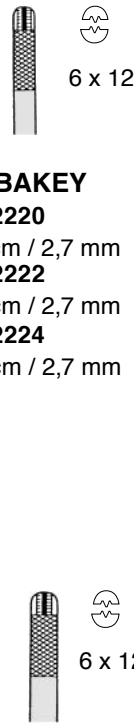

DEBAKEY
14.2230
15 cm / 3,5 mm
14.2232
19 cm / 3,5 mm
14.2234
24 cm / 3,5 mm



DEBAKEY
14.2240
15 cm / 2 mm
14.2242
19 cm / 2 mm
14.2244
24 cm / 2 mm



GERALD
14.2320 18 cm



BONNEY
14.2390 18 cm



GERALD
14.2820 18 cm 1x2



GILLIES
14.2570 15 cm 1x2



OEHLER

- 14.2623 14 cm
- 14.2625 16 cm
- 14.2627 18 cm
- 14.2628 20 cm
- 14.2629 25 cm
- 14.2630 30 cm



BONNEY

- 14.2890 18 cm 1x2



ADSON-BROWN

- 14.2900 12 cm 9x9

Kein Ankleben von koagulierte[m] Gewebe

„Bei der Koagulation des Gewebes kann es zum Verkleben des koagulierten Gewebes mit der Pinzettenspitze kommen. Dieser unerwünschte Effekt kann durch den Einsatz von NONSTICK Bipolar-Pinzetten praktisch vollständig verhindert werden. Zeitraubendes Reinigen dieser Pinzetten während der OP entfällt, was Unterbrechungen beim Arbeiten erheblich reduziert. Pinzettenspitzen aus Material mit besonders guten thermischen Eigenschaften ermöglichen diese Verbesserung. Der “NONSTICK“ Effekt bleibt dauerhaft erhalten und wird auch durch häufiges Sterilisieren nicht gemindert.“

No adhesion of tissue during coagulation

During coagulation tissue may stick to the forceps-tip. This adverse effect can be avoided almost completely by using NONSTICK Bipolar Forceps. Forceps-tips of material with excellent thermal properties prevent tissue from sticking to the instrument. Cleaning of the instrument during operation is no longer required thus reducing the interruptions during the procedure. The NONSTICK-effect is permanent, even if subject to frequent sterilization.

Aucune adhésion du tissu coagulé

Pendant la coagulation du tissu il se peut que le tissu coagulé adhère à la pointe de la pince. L'utilisation des pinces NONSTICK permet de supprimer cet effet indésirable quasi complètement. Le nettoyage difficile et pénible des pinces pendant l'opération n'est plus nécessaire, ce qui réduit considérablement les interruptions de travail. Tout cela est possible, car les pointes des pinces sont faites d'une manière présentant des caractéristiques thermiques excellentes. L'effet NONSTICK (non-adhésif) est assuré en permanence et n'est pas ou plus réduit par une stérilisation fréquente.

Sin adhesión del tejido coagulado

Al coagular un tejido puede que el tejido coagulado quede adherido a la punta de las pinzas. Este efecto no deseado puede evitarse prácticamente por completo usando las pinzas bipolares NONSTICK. La limpieza molesta de las pinzas durante la operación que además exige mucho tiempo queda suprimida lo que reduce considerablemente las interrupciones en el trabajo. Esto se consigue aplicando un material con propiedades térmicas especialmente buenas a las puntas de las pinzas. El efecto NONSTICK (antiadhesivo) es duradero y no se verá mermado por esterilizaciones frecuentes.

Nessuna adesione des tessuto coagulato

Con la coagulazione des tessuto può darsi che il tessuto coagulato si attacchi alla punta della pinza. L'uso delle pinze bipolari NONSTICK permette di impedire questo effetto indesiderato quasi completamente. La pulizia faticosa delle pinze che richiede molto tempo non è più necessaria durante l'operazione, il che riduce notevolmente le interruzioni di lavoro. C'è è possibile utilizzando un materiale con caratteristiche termiche eccellenti per le punte delle pinze. L'effetto NONSTICK (non adesivo) si mantiene permanentemente e non viene neanche ridotto da una sterilizzazione frequente.



Flachstecker / flat plug / fiche plat / enchufe plano / spina piatta



2-Pin-Stecker / 2-pin-plug / fiche 2-pin / clavija 2-pin / spina 2-pin

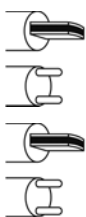

14.3500 11 cm/0,25 mm

14.3503 11 cm,/0,25 mm

14.3500.2 11 cm/0,25 mm

14.3503.2 11 cm/0,25 mm

14.3502 11 cm/0,60 mm

14.3505 11 cm/0,60 mm

14.3502.2 11 cm/0,60 mm

14.3505.2 11 cm/0,60 mm



Flachstecker / flat plug / fiche plat / enchufe plano / spina piatta

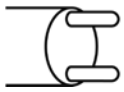

2-Pin-Stecker / 2-pin-plug / fiche 2-pin / clavija 2-pin / spina 2-pin



14.3600 15 cm/0,3 mm

14.3602 18 cm/0,3 mm

14.3604 20 cm/0,3 mm

14.3606 22 cm/0,3 mm



14.3600.2 15 cm/0,3 mm

14.3602.2 18 cm/0,3 mm

14.3604.2 20 cm/0,3 mm

14.3606.2 22 cm/0,3 mm



14.3610 15 cm/1,0 mm

14.3612 18 cm/1,0 mm

14.3614 20 cm/1,0 mm

14.3616 22 cm/1,0 mm



14.3610.2 15 cm/1,0 mm

14.3612.2 18 cm/1,0 mm

14.3614.2 20 cm/1,0 mm

14.3616.2 22 cm/1,0 mm



14.3620 15 cm/2,0 mm

14.3622 18 cm/2,0 mm

14.3624 20 cm/2,0 mm

14.3626 22 cm/2,0 mm



14.3620.2 15 cm/2,0 mm

14.3622.2 18 cm/2,0 mm

14.3624.2 20 cm/2,0 mm

14.3626.2 22 cm/2,0 mm

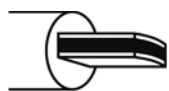

Flachstecker / flat plug / fiche plat / enchufe plano / spina piatta



2-Pin-Stecker / 2-pin-plug / fiche 2-pin / clavija 2-pin / spina 2-pin



14.3641 15 cm/0,3 mm



14.3641.2 15 cm/0,3 mm



14.3651 15 cm/1,0 mm



14.3651.2 15 cm/1,0 mm



14.3661 15 cm/2,0 mm



14.3661.2 15 cm/2,0 mm

14.3643 18 cm/0,3 mm

14.3643.2 18 cm/0,3 mm

14.3653 18 cm/1,0 mm

14.3653.2 18 cm/1,0 mm

14.3663 18 cm/2,0 mm

14.3663.2 18 cm/2,0 mm





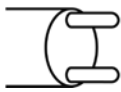

"NONSTICK" BIPOLARE PINZETTEN
 "NONSTICK" BIPOLAR FORCEPS
 "NONSTICK" PINCES BIPOLAIRES
 "NONSTICK" PINZAS BIPOLARES
 "NONSTICK" PINZE BIPOLARI

PRO-MED

 Flachstecker / flat plug / fiche plat / enchufe plano / spina piatta

 2-Pin-Stecker / 2-pin-plug / fiche 2-pin / clavija 2-pin / spina 2-pin



	14.3702 18 cm/0,3 mm	14.3704 20 cm/0,3 mm	14.3706 22 cm/0,3 mm	14.3708 24 cm/0,3 mm
	14.3702.2 18 cm/0,3 mm	14.3704.2 20 cm/0,3 mm	14.3706.2 22 cm/0,3 mm	14.3708.2 24 cm/0,3 mm
	14.3712 18 cm/1,0 mm	14.3714 20 cm/1,0 mm	14.3716 22 cm/1,0 mm	14.3718 24 cm/1,0 mm
	14.3712.2 18 cm/1,0 mm	14.3714.2 20 cm/1,0 mm	14.3716.2 22 cm/1,0 mm	14.3718.2 24 cm/1,0 mm
	14.3722 18 cm/2,0 mm	14.3724 20 cm/2,0 mm	14.3726 22 cm/2,0 mm	14.3728 24 cm/2,0 mm
	14.3722.2 18 cm/2,0 mm	14.3724.2 20 cm/2,0 mm	14.3726.2 22 cm/2,0 mm	14.3728.2 24 cm/2,0 mm

Unsere bipolaren Pinzetten sind mit Flackstecker oder 2-Pin-Stecker lieferbar und dadurch kompatibel mit allen gängigen HF-Generatoren.

Our bipolar Forceps are available with flat plug or 2-pin plug and thus compatible with all common high-frequency generators.

compatibles avec tous les générateurs H.F. courants. Tous nos pinces bipolaires sont disponibles avec connecteur plat ou connecteur à 2 pins, et, donc

Toadas las pinzas bipolares son disponibles con enchufes planos o enchufes a 2 pins por lo que son compatibles con todos los generadores AF corrientes.

Tutte le pinze bipolari sono disponibili con spina piatta o spina a 2 pin e, quindi, compatibili con tutti i generatori correnti ad alta frequenza.

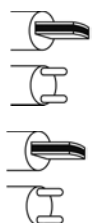
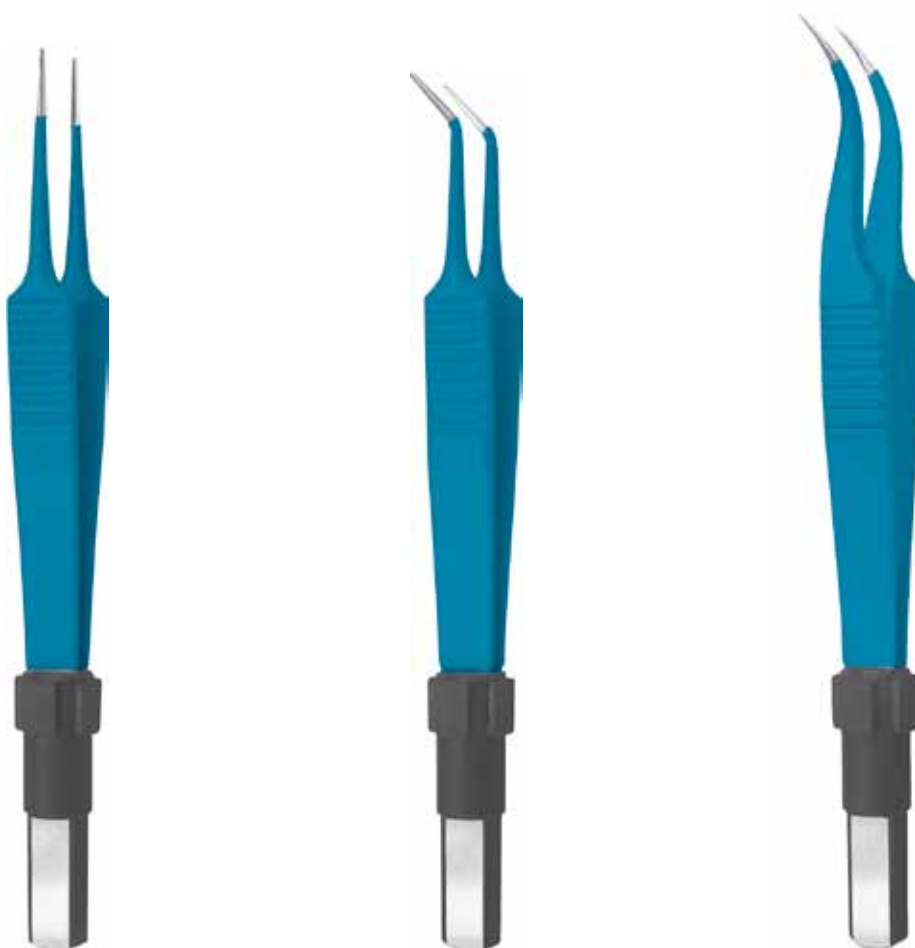

14.3000 11 cm/0,25 mm

14.3000.2 11 cm/0,25 mm

14.3002 11 cm/0,60 mm

14.3002.2 11 cm/0,60 mm

14.3003 11 cm/0,25 mm

14.3003.2 11 cm/0,25 mm

14.3005 11 cm/0,60 mm

14.3005.2 11 cm/0,60 mm

14.3007 11 cm/0,25 mm

14.3007.2 11 cm/0,25 mm

14.3009 11 cm/0,60 mm

14.3009.2 11 cm/0,60 mm

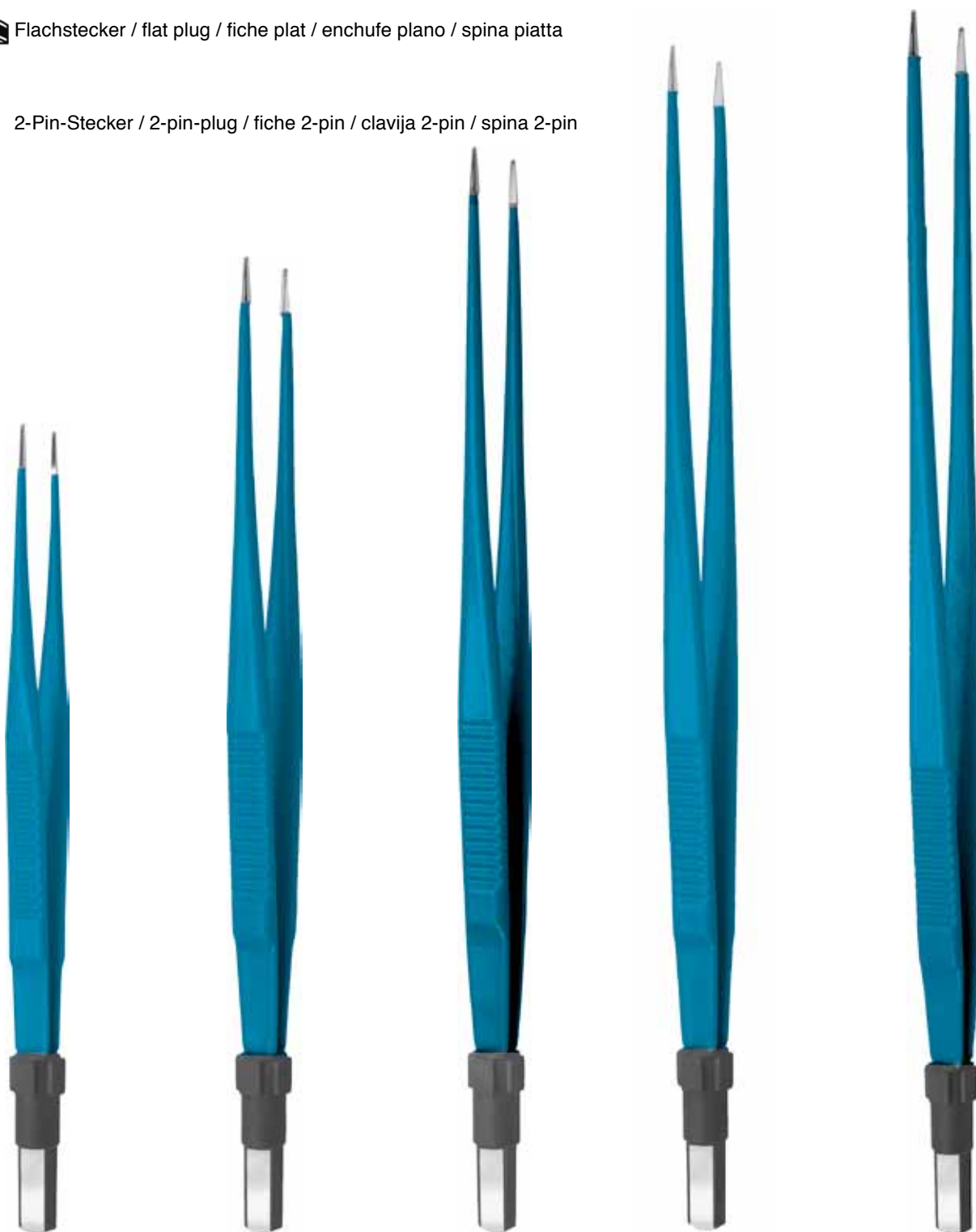
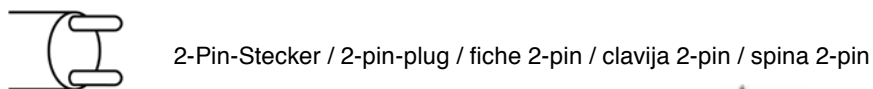
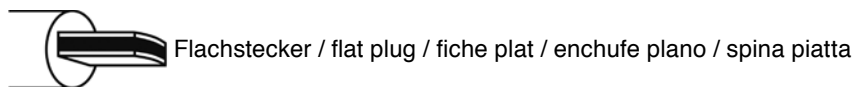

	14.3100 1 5 cm/0,3 mm	14.3102 18 cm/0,3 mm	14.3104 20 cm/0,3 mm	14.3106 22 cm/0,3 mm	14.3108 24 cm/0,3 mm
	14.3100.2 15 cm/0,3 mm	14.3102.2 18 cm/0,3 mm	14.3104.2 20 cm/0,3 mm	14.3106.2 22 cm/0,3 mm	14.3108.2 24 cm/0,3 mm
	14.3110 15 cm/1,0 mm	14.3112 18 cm/1,0 mm	14.3114 20 cm/1,0 mm	14.3116 22 cm/1,0 mm	14.3118 24 cm/1,0 mm
	14.3110.2 15 cm/1,0 mm	14.3112.2 18 cm/1,0 mm	14.3114.2 20 cm/1,0 mm	14.3116.2 22 cm/1,0 mm	14.3118.2 24 cm/1,0 mm
	14.3120 15 cm/2,0 mm	14.3122 18 cm/2,0 mm	14.3124 18 cm/2,0 mm	14.3126 22 cm/2,0 mm	14.3128 24 cm/2,0 mm
	14.3120.2 15 cm/2,0 mm	14.3122.2 18 cm/2,0 mm	14.3124.2 18 cm/2,0 mm	14.3126.2 22 cm/2,0 mm	14.3128.2 24 cm/2,0 mm



Flachstecker / flat plug / fiche plat / enchufe plano / spina piatta

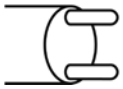

2-Pin-Stecker / 2-pin-plug / fiche 2-pin / clavija 2-pin / spina 2-pin



14.3141 15 cm/0,3 mm **14.3143** 18 cm/0,3 mm **14.3145** 20 cm/0,3 mm **14.3147** 22 cm/0,3 mm **14.3149** 24 cm/0,3 mm



14.3141.2 15 cm/0,3 mm **14.3143.2** 18 cm/0,3 mm **14.3145.2** 20 cm/0,3 mm **14.3147.2** 22 cm/0,3 mm **14.3149.2** 24 cm/0,3 mm



14.3151 15 cm/1,0 mm **14.3153** 18 cm/1,0 mm **14.3155** 20 cm/1,0 mm **14.3157** 22 cm/1,0 mm **14.3159** 24 cm/1,0 mm



14.3151.2 15 cm/1,0 mm **14.3153.2** 18 cm/1,0 mm **14.3155.2** 20 cm/1,0 mm **14.3157.2** 22 cm/1,0 mm **14.3159.2** 24 cm/1,0 mm



14.3161 15 cm/2,0 mm **14.3163** 18 cm/2,0 mm **14.3165** 20 cm/2,0 mm **14.3167** 22 cm/2,0 mm **14.3169** 24 cm/2,0 mm



14.3161.2 15 cm/2,0 mm **14.3163.2** 18 cm/2,0 mm **14.3165.2** 20 cm/2,0 mm **14.3167.2** 22 cm/2,0 mm **14.3169.2** 24 cm/2,0 mm

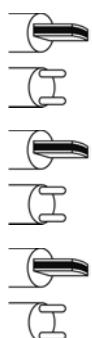
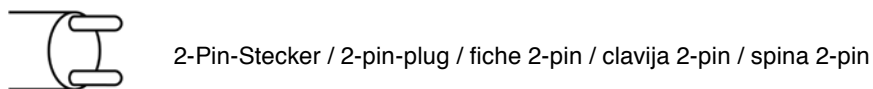
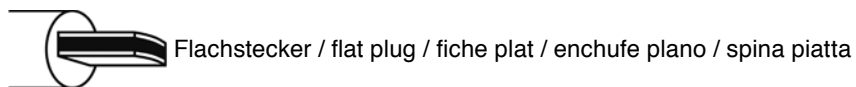

14.3061 17 cm/0,3 mm
14.3061.2 17 cm/0,3 mm
14.3071 17 cm/1,0 mm
14.3071.2 17 cm/1,0 mm
14.3081 17 cm/2,0 mm
14.3081.2 17 cm/2,0 mm

14.3202 18 cm/0,3 mm
14.3202.2 18 cm/0,3 mm
14.3212 18 cm/1,0 mm
14.3212.2 18 cm/1,0 mm
14.3222 18 cm/2,0 mm
14.3222.2 18 cm/2,0 mm

14.3204 20 cm/0,3 mm
14.3204.2 20 cm/0,3 mm
14.3214 20 cm/1,0 mm
14.3214.2 20 cm/1,0 mm
14.3224 20 cm/2,0 mm
14.3224.2 20 cm/2,0 mm



Flachstecker / flat plug / fiche plat / enchufe plano / spina piatta



2-Pin-Stecker / 2-pin-plug / fiche 2-pin / clavija 2-pin / spina 2-pin

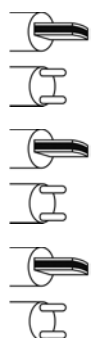

14.3206 22 cm/0,3 mm

14.3206.2 22 cm/0,3 mm

14.3216 22 cm/1,0 mm

14.3216.2 22 cm/1,0 mm

14.3226 22 cm/2,0 mm

14.3226.2 22 cm/2,0 mm

14.3208 24 cm/0,3 mm

14.3208.2 24 cm/0,3 mm

14.3218 24 cm/1,0 mm

14.3218.2 24 cm/1,0 mm

14.3228 24 cm/2,0 mm

14.3228.2 24 cm/2,0 mm

BIPOLAR-Kabel 3 m, f. Bipolpinzetten mit Flachstecker

Cables 3 mtr. for Forceps with flat plug

Cordons 3 mtr. pour pinces avec fiches plats

Cables 3 mtr. para pinzas con clavijas plano

Cavi 3 mtr. per pinze con spine piatto



14.3900

2-Bananenstecker

2-banana-plug

fiche 2-bananas

clavija 2-bananas

spina "2 banani"



BIPOLAR-Kabel 3 m, f. Bipolpinzetten mit "2-Pin"-Stecker

Cables 3 mtr. for Forceps with "2-pin"-plug

Cordons 3 mtr. pour pinces avec fiches <<2-pin>>

Cables 3 mtr. para pinzas con 2-pin clavija

Cavi 3 mtr. per pinze con spina a due pin



14.3905

2-Bananenstecker

2-banana-plug

fiche 2-bananas

clavija 2-bananas

spina "2 banani"

14.3910

Model Erbe

Model Erbe

Modèle Erbe

Modelo Erbe

Modello Erbe



14.3915

Model Erbe

Model Erbe

Modèle Erbe

Modelo Erbe

Modello Erbe

14.3920

Model Martin

Model Martin

Modèle Martin

Modelo Martin

Modello Martin



14.3925

Model Martin

Model Martin

Modèle Martin

Modelo Martin

Modello Martin

14.3930

Model Valleylab

Model Valleylab

Modèle Valleylab

Modelo Valleylab

Modello Valleylab



14.3935

Model Valleylab

Model Valleylab

Modèle Valleylab

Modelo Valleylab

Modello Valleylab

14.3940

Model Aesculap GK50

Model Aesculap GK50

Modèle Aesculap GK50

Modelo Aesculap GK50

Modello Aesculap GK50



14.3945

Model Aesculap GK50

Model Aesculap GK50

Modèle Aesculap GK50

Modelo Aesculap GK50

Modello Aesculap GK50

14.3950

Model Codman CMC II

Model Codman CMC II

Modèle Codman CMC II

Modelo Codman CMC II

Modello Codman CMC II



14.3955

Model Codman CMC II

Model Codman CMC II

Modèle Codman CMC II

Modelo Codman CMC II

Modello Codman CMC II

ARTERIENKLEMMEN, PRÄPARIERKLEMMEN
HEMOSTATIC- AND DISSECTING FORCEPS
PINCES HEMOSTATIQUES ET A PREPARATION
PINZAS HEMOSTATICAS Y PARA PREPARACIONES
PINZE EMOSTATICHE E PER PREPARAZIONE

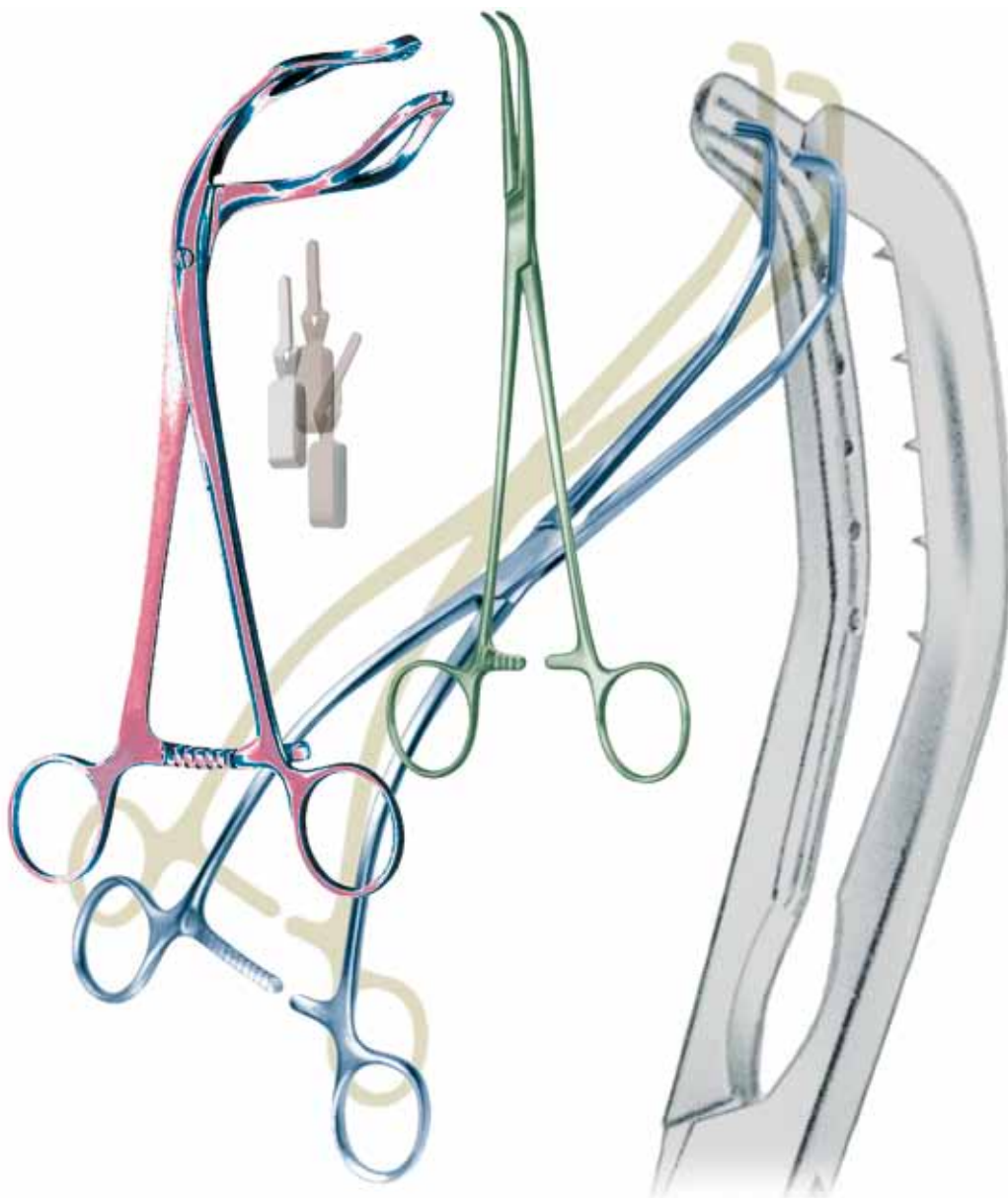



GLOVER

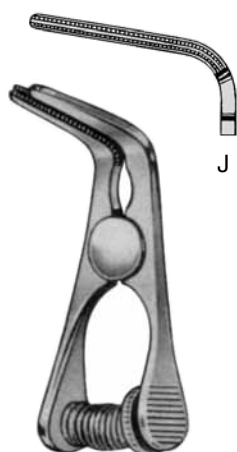
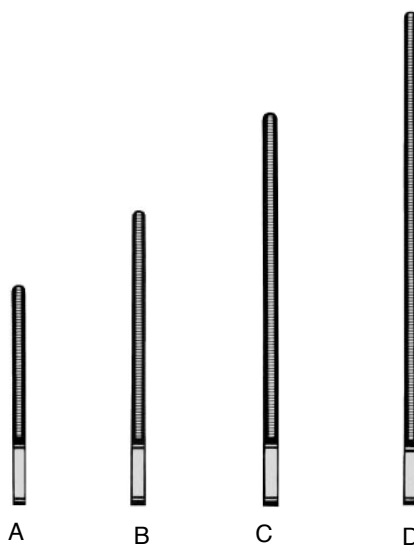

GLOVER

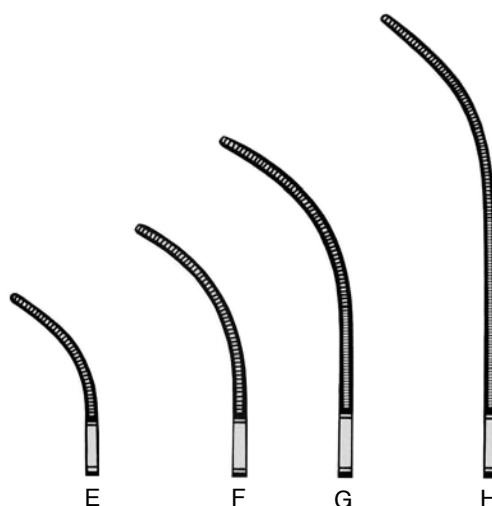

Artikel Item	Fig.	Gesamtlänge Overall length Longeur complet largo total Lunghezza total	Maullänge Jaw length longeur de mors largo de boca Lunghezza del morso	Gewicht Weight Poids Peso Peso
41.0000	A	60 mm	20 mm	5 g
41.0001	E	55 mm	20 mm	5 g
41.0005	B	70 mm	30 mm	9 g
41.0006	F	65 mm	30 mm	9 g
41.0010	C	90 mm	43 mm	12 g
41.0011	G	85 mm	43 mm	12 g
41.0015	D	105 mm	56 mm	14 g
41.0016	H	100 mm	56 mm	14 g
41.0019	J	55 mm	25 mm	7 g



GREGORY

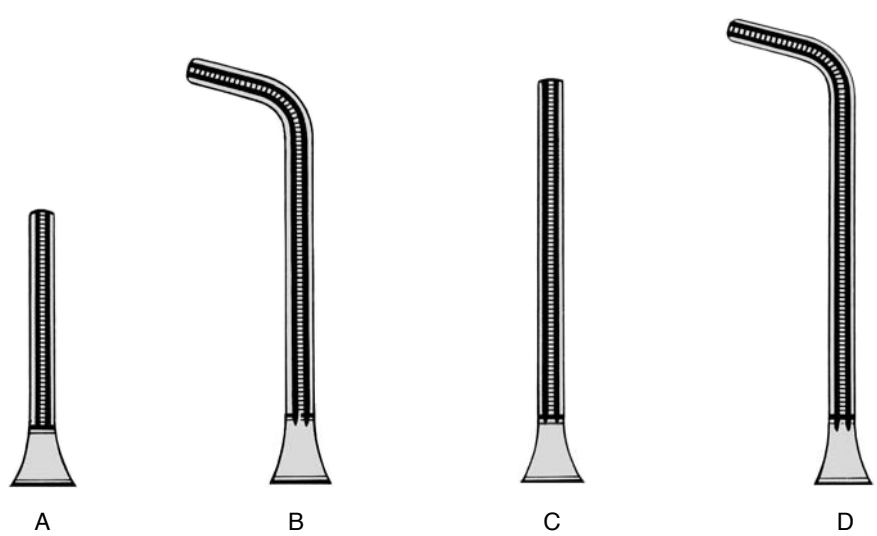

Artikel Item	Fig.	Gesamtlänge Overall length Longeur complet largo total Lunghezza total	Maullänge Jaw length longeur de mors largo de boca Lunghezza del morso	Gewicht Weight Poids Peso Peso
41.0020	A	90 mm	27 mm	11 g
41.0021	B	100 mm	44 mm	12 g
41.0022	C	110 mm	55 mm	12 g
41.0023	D	110 mm	60 mm	12 g



GREGORY

nach links gebogen
 curved to left
 courbe à gauche
 curva a la izquierda
 curvo a sinistra

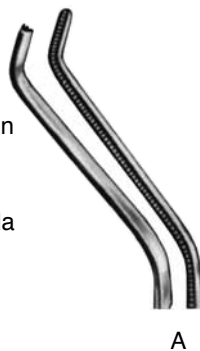

nach rechts gebogen
 curved to right
 courbe à droit
 curva a la derecha
 curvo a destra



Artikel Item	Fig.	Gesamtlänge Overall length Longeur complet largo total Lunghezza total	Maullänge Jaw length longeur de mors largo de boca Lunghezza del morso	Gewicht Weight Poids Peso Peso
41.0024	A	110 mm	60 mm	12 g
41.0025	B	110 mm	60 mm	12 g

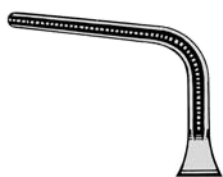

30 mm Maullänge
 Jaw length
 longueur de mors
 largo de boca
 Lunghezza del morso

SANTULLI
41.0028
 70 mm



DIETRICH



A

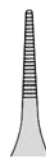

B

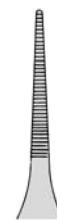

C



D

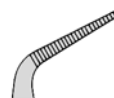

E

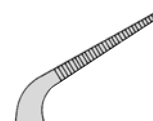

F

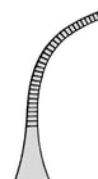

G

Artikel Item	Fig.	Gesamtlänge Overall length Longeur complet largo total Lunghezza total	Maullänge Jaw length longueur de mors largo de boca Lunghezza del morso	Gewicht Weight Poids Peso Peso	Schliessdruck Closing pressure Pression d'Occlusion Presión de cierre Pressione di chiusura
41.0030	A	50 mm	8 mm	3 g	80
41.0031	D	43 mm	8 mm	3 g	80
41.0032	B	53 mm	12 mm	3 g	80
41.0033	E	45 mm	12 mm	3 g	80
41.0034	C	60 mm	20 mm	3 g	80
41.0035	F	50 mm	20 mm	3 g	80
41.0037	G	54 mm	20 mm	3 g	80



DEBAKEY-MICRO

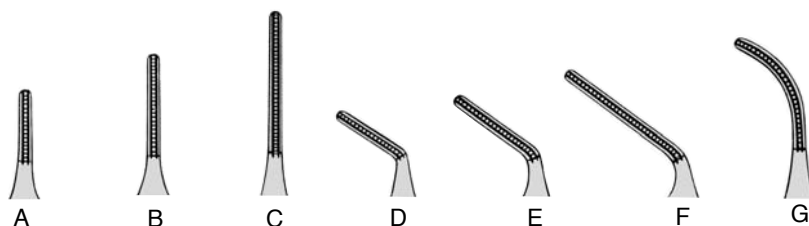

Artikel Item	Fig.	Gesamtlänge Overall length Longeur complet largo total Lunghezza total	Maullänge Jaw length longeur de mors largo de boca Lunghezza del morso	Gewicht Weight Poids Peso	Schliessdruck Closing pressure Pression d'Occlusion Presión de cierre Pressione di chiusura
41.0090	A	47 mm	10 mm	3 g	180
41.0091	D	44 mm	10 mm	3 g	180
41.0092	B	51 mm	14 mm	3 g	180
41.0093	E	46 mm	14 mm	3 g	180
41.0094	C	57 mm	20 mm	3 g	180
41.0095	F	49 mm	20 mm	3 g	180
41.0099	G	54 mm	20 mm	3 g	180



DEBAKEY

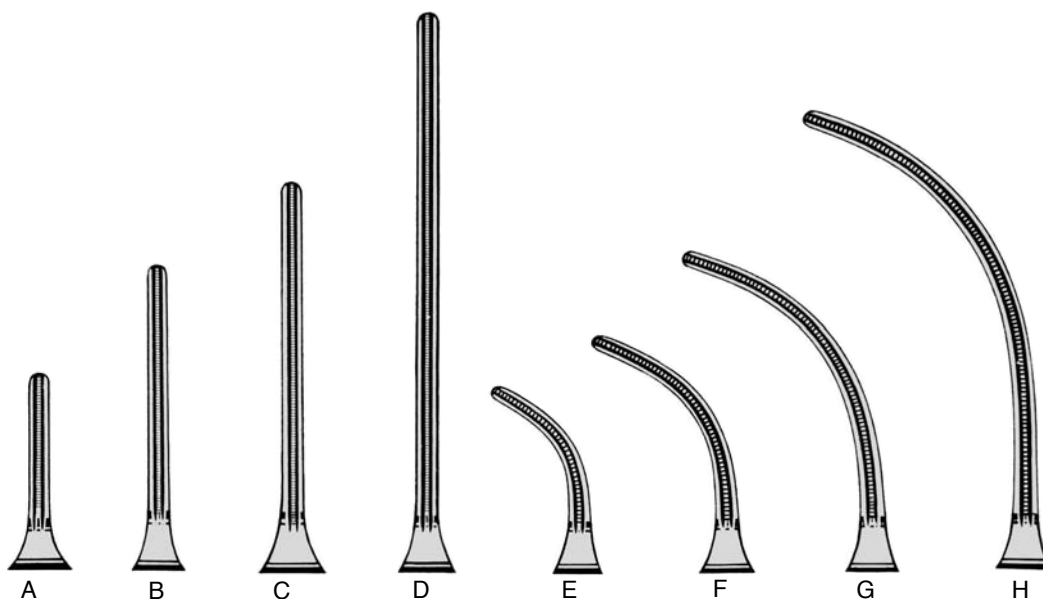

Artikel Item	Fig.	Gesamtlänge Overall length Longeur complet largo total Lunghezza total	Maullänge Jaw length longeur de mors largo de boca Lunghezza del morso	Gewicht Weight Poids Peso
41.0100	A	80 mm	20 mm	10 g
41.0101	E	75 mm	20 mm	10 g
41.0110	B	90 mm	30 mm	11 g
41.0111	F	85 mm	30 mm	11 g
41.0115	C	105 mm	45 mm	12 g
41.0116	G	95 mm	45 mm	12 g
41.0120	D	125 mm	68 mm	12 g
41.0121	H	115 mm	68 mm	12 g



CARREL
15.0098 8,5 cm



15.0100

HARTMANN
10 cm



15.0108
glattes Maul
smooth jaws
lisses
lisas
liscio



HARTMANN
15.0101 10 cm

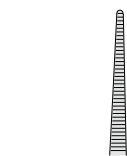

HARTMANN-MICRO
15.0102 10 cm



HARTMANN-MICRO
15.0103 10 cm



HARTMANN
15.0104 10 cm 1x2



HARTMANN
15.0105 10 cm 1x2



15.0117

JACOBSON-MICRO
 15.0116 12,5 cm

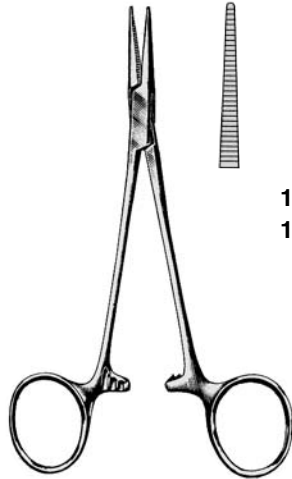

15.0121 12,5 cm
 15.0125 14 cm

MOSQUITO
 15.0120 12,5 cm
 15.0120L 12,5 cm
 linkshändig / left-handed
 pour gaucher / para zurdo / per mano sinistra
 15.0124 14 cm



15.0121L
 linkshändig
 left-handed
 pour gaucher
 para zurdo
 per mano sinistra



15.0123

MICRO-MOSQUITO
 15.0122 12,5 cm



15.0129 1x2

MICRO-MOSQUITO
 15.0128 12 cm 1x2



15.0127 12,5 cm 1x2
 15.0137 14 cm 1x2

MOSQUITO
 15.0126 12,5 cm 1x2
 15.0136 14 cm 1x2



MICRO-MOSQUITO
 15.0139 12,5 cm
 kreuzgerieft / cross-serrated
 rainures croisées
 estriada en forma de cruz
 striatura cruciforme

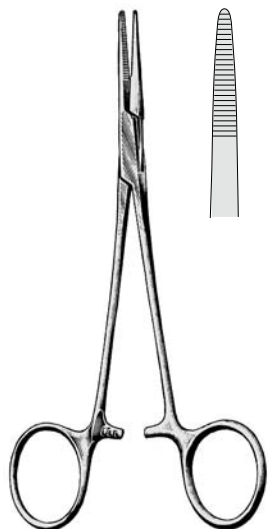

15.0131

PROVIDENCE-HOSPITAL
15.0130 14,5 cm

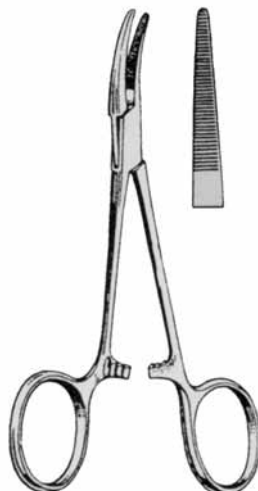

15.0181

DUNHILL
15.0180 12,5 cm

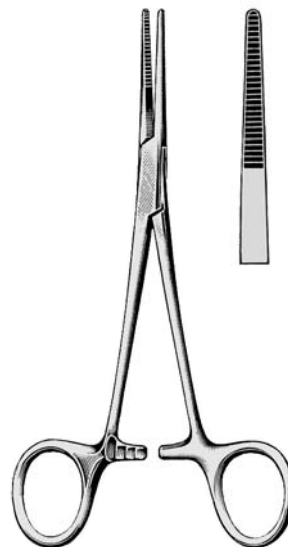

15.0201

KELLY
15.0200 14 cm



CRILE
15.0210 14 cm



15.0211

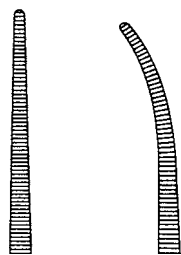

15.0212

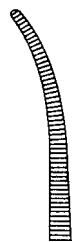

15.0213



15.0214 1x2



15.0215 1x2

CRILE-BABY



15.0240

15.0241

RANKIN-KELLY
16 cm



15.0251

RANKIN-CRILE
15.0250 16 cm



15.0253
1x2

RANKIN-CRILE
15.0252 16 cm 1x2



15.0260
14 cm

15.0262
16 cm

15.0261
14 cm

15.0263
16 cm

COLLER-CRILE

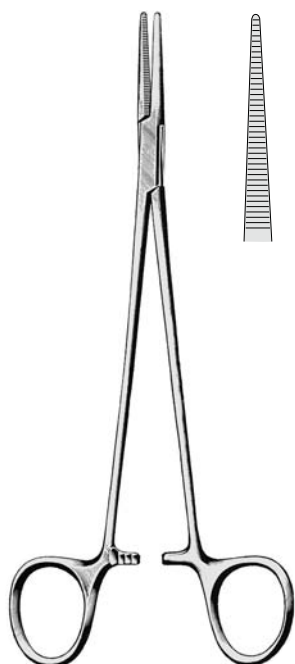

HALSTED
15.0300 18 cm
15.0302 21 cm

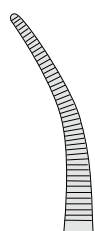

15.0301 18 cm
15.0303 21 cm



15.0306 18 cm 1x2
15.0308 21 cm 1x2

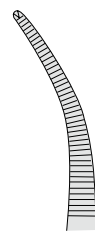

15.0307 18 cm 1x2
15.0309 21 cm 1x2



ADSON-BABY
15.0313 14 cm

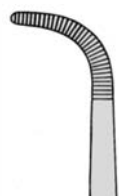

15.0315
18 cm



ADSON
15.0310 18,5 cm

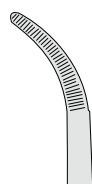

15.0311

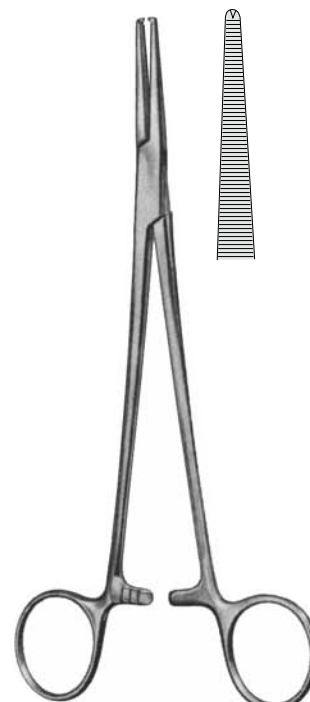

ADSON
15.0316 18,5 cm 1x2

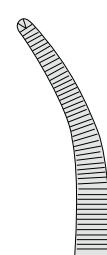

15.0317 1x2



HEISS
 15.0320 20 cm

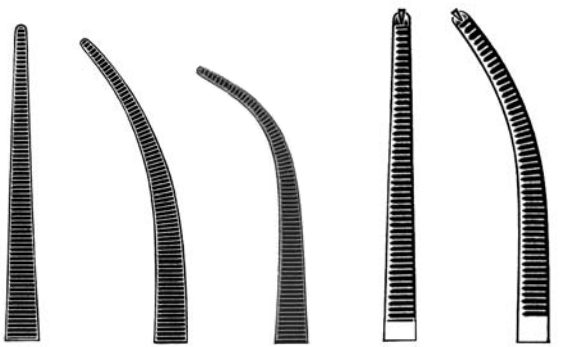

15.0321 15.0323 15.0324 15.0325
 1x2 1x2



FUCHSIG
 15.0331 18,5 cm

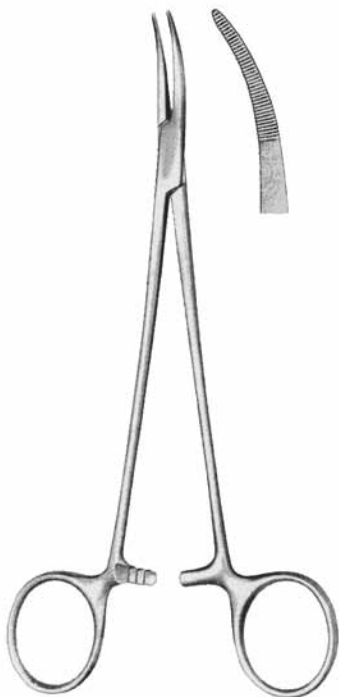

NISSEN
 15.0335 19 cm

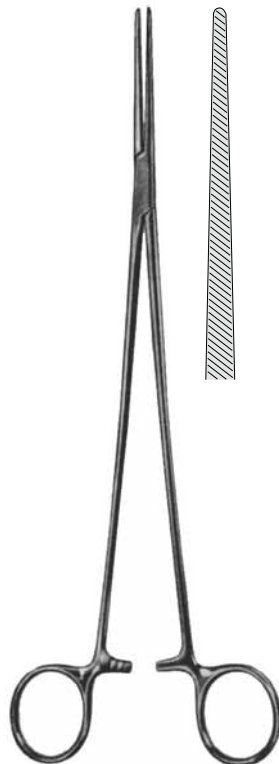

BENGOLEA
 15.0360 20 cm
 15.0362 26 cm

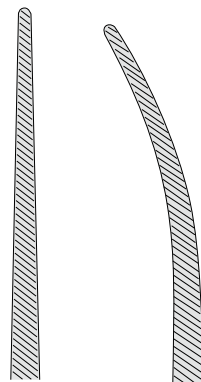

15.0361 20 cm
 15.0363 26 cm

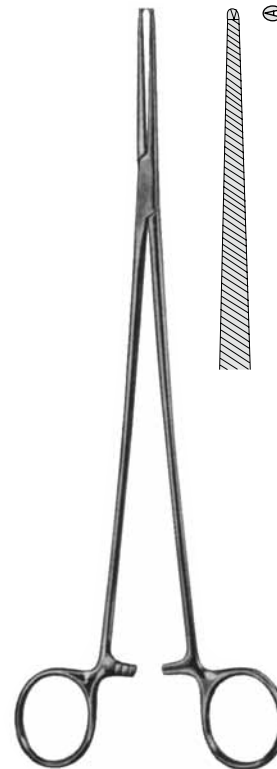

BENGOLEA
 15.0364 20 cm 1x2
 15.0366 26 cm 1x2

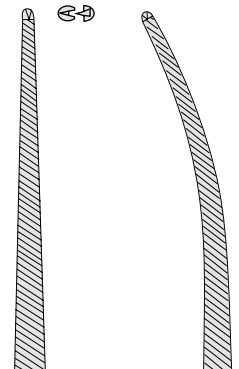

15.0365 20 cm 1x2
 15.0367 26 cm 1x2



BRIDGE
15.0392 28 cm

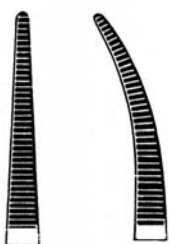

15.0393
28 cm

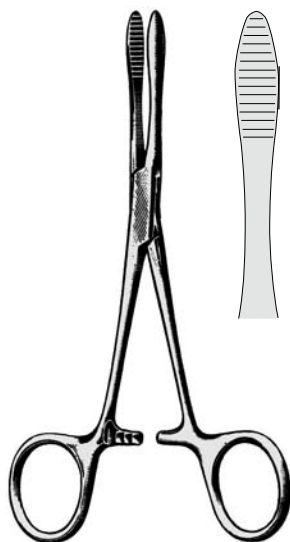

PEAN
15.0404 12,5 cm
15.0406 14,5 cm
15.0408 16 cm

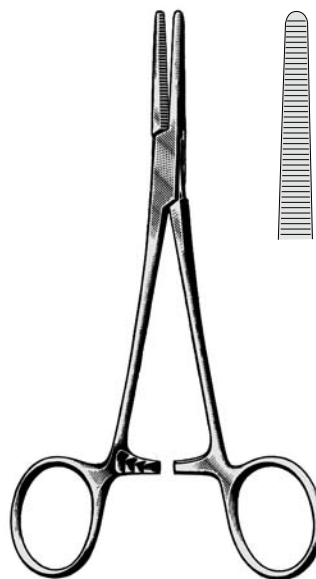

SPENCER-WELLS
15.0410 13 cm
15.0412 14 cm
15.0414 15 cm
15.0416 18 cm
15.0418 20 cm

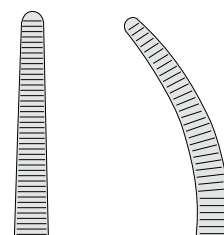

SPENCER-WELLS
15.0411 13 cm
15.0413 14 cm
15.0415 15 cm
15.0417 18 cm
15.0419 20 cm



ROCH-CARMALT
15.0430 16 cm
15.0432 20 cm

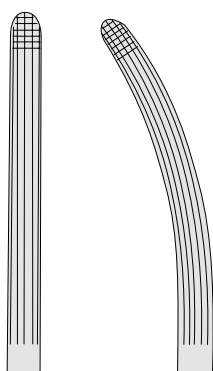

15.0431 16 cm
15.0433 20 cm

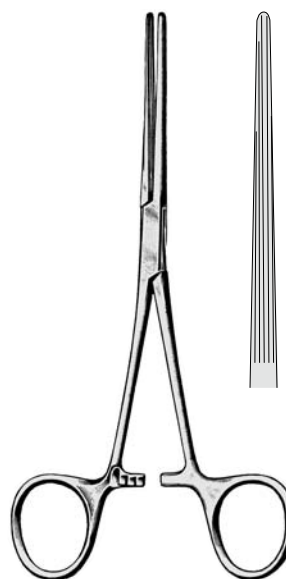

BAINBRIDGE
15.1320 15,5 cm
15.1322 18,0 cm

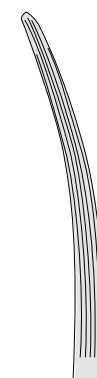

15.1321 15,5 cm
15.1323 18,0 cm

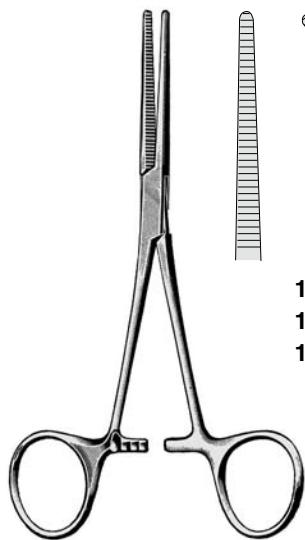

- 15.0451 13 cm
- 15.0453 14 cm
- 15.0455 16 cm

PEAN-FINO

- 15.0450 13 cm
- 15.0452 14 cm
- 15.0454 16 cm

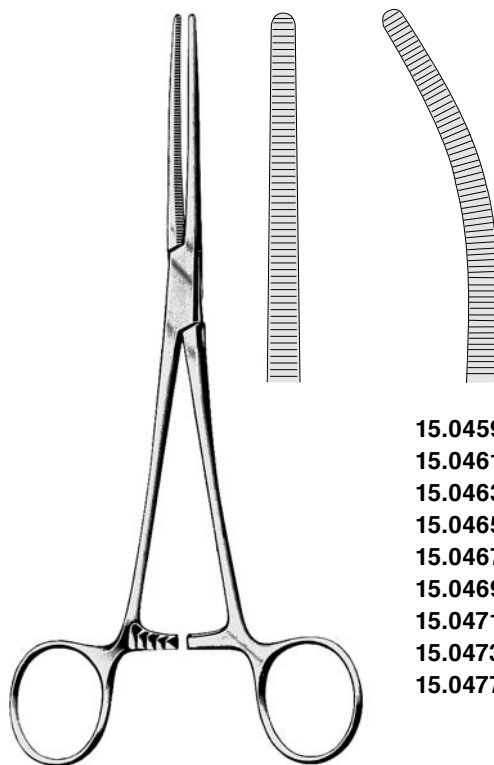

- 15.0459 13 cm
- 15.0461 14 cm
- 15.0463 16 cm
- 15.0465 18 cm
- 15.0467 20 cm
- 15.0469 22 cm
- 15.0471 24 cm
- 15.0473 26 cm
- 15.0477 30 cm

ROCHESTER-PEAN

- 15.0458 13 cm
- 15.0460 14 cm
- 15.0462 16 cm
- 15.0464 18 cm
- 15.0466 20 cm
- 15.0468 22 cm
- 15.0470 24 cm
- 15.0472 26 cm
- 15.0476 30 cm



15.0481

ROBERTS

- 15.0480 22 cm

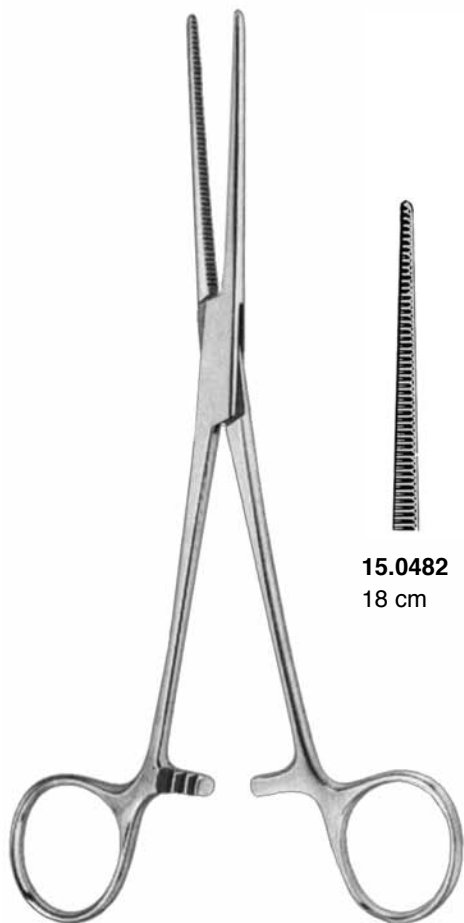

OLIVECRONA

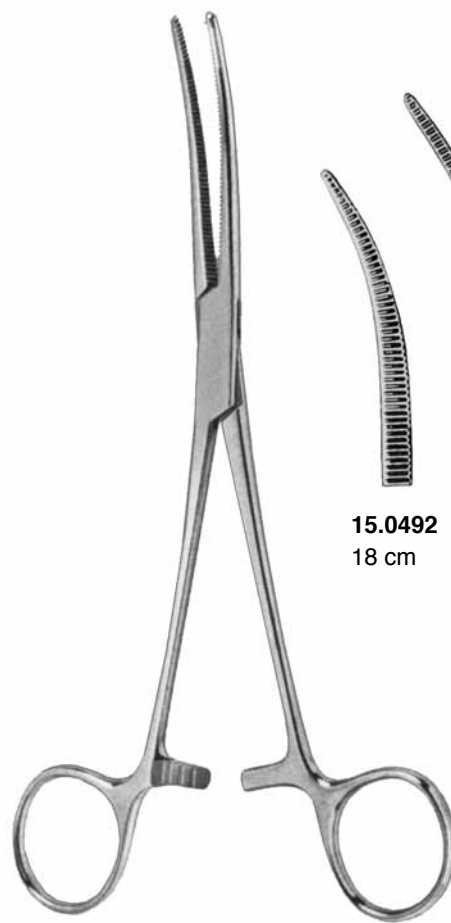
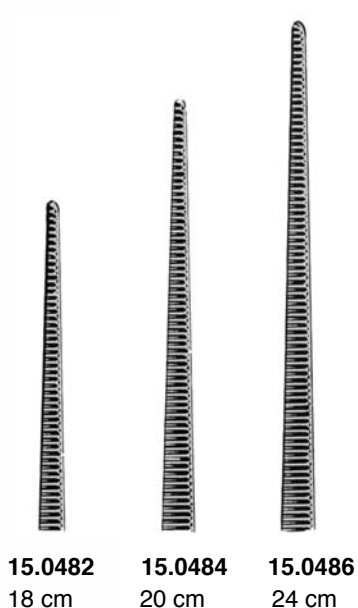

CRAFOORD

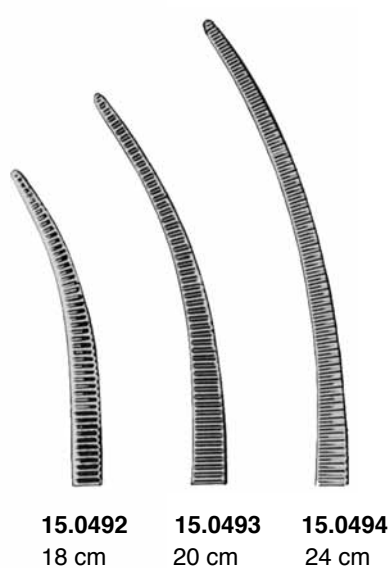

CRAFOORD-SELLORS
24 cm

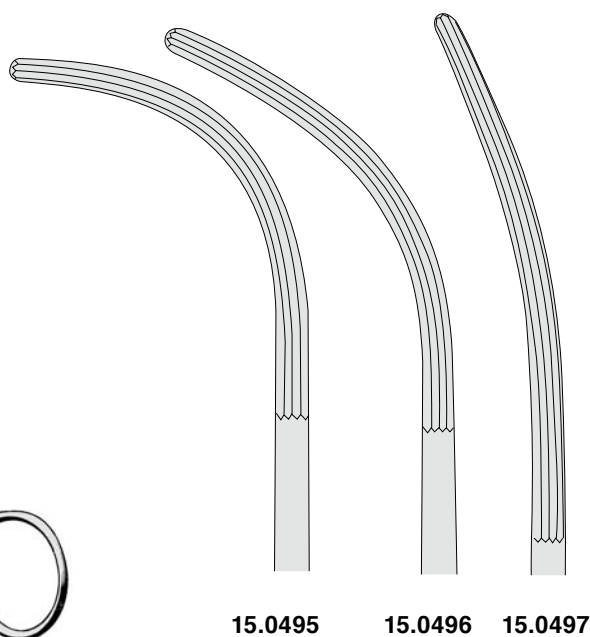



ROCHESTER-OCHSNER

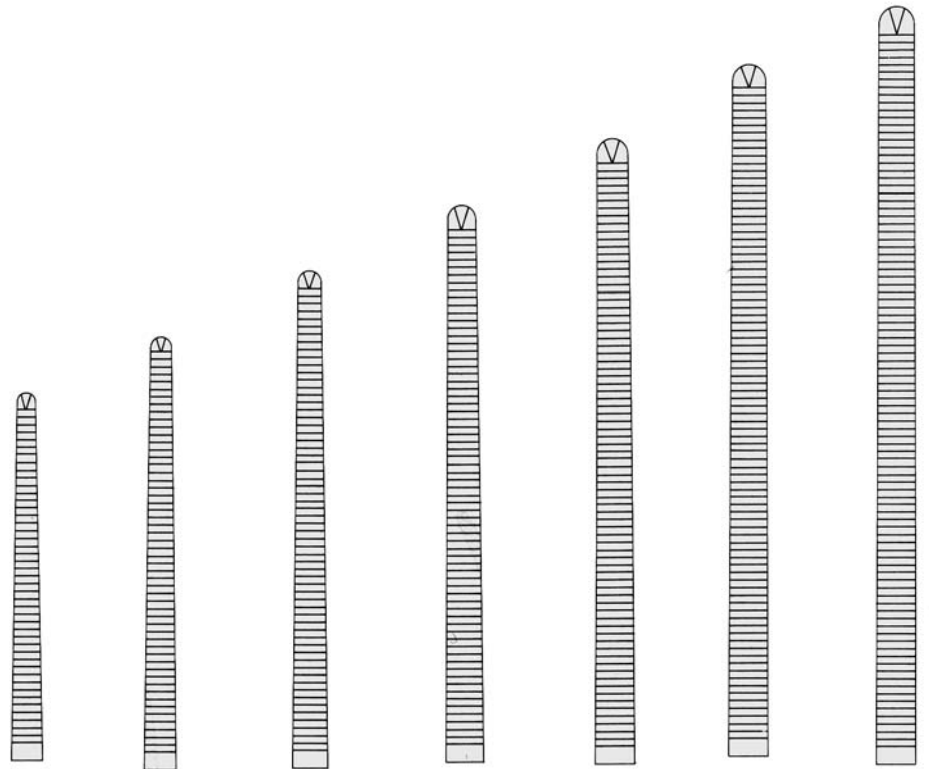

15.0620	15.0622	15.0624	15.0626	15.0628	15.0630	15.0632
16 cm	18 cm	20 cm	22 cm	24 cm	26 cm	30 cm
1x2	1x2	1x2	1x2	1x2	1x2	1x2

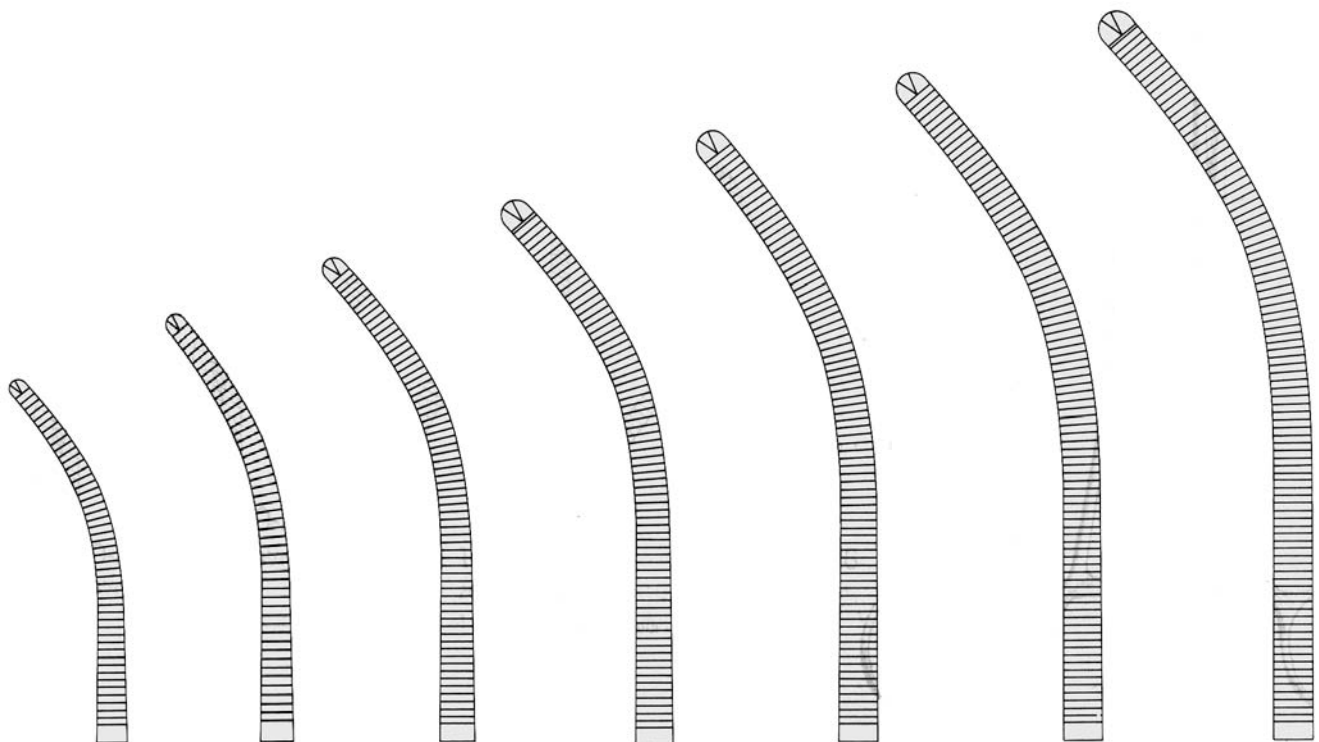

15.0621	15.0623	15.0625	15.0627	15.0629	15.0631	15.0633
16 cm	18 cm	20 cm	22 cm	24 cm	26 cm	30 cm
1x2	1x2	1x2	1x2	1x2	1x2	1x2



MIXTER-O'SHAUGHNESSY

15.0701 15 cm

15.0703 19 cm

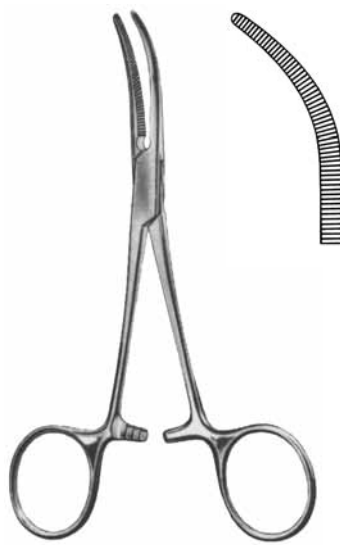

OVERHOLT-BABY

15.0720 14 cm

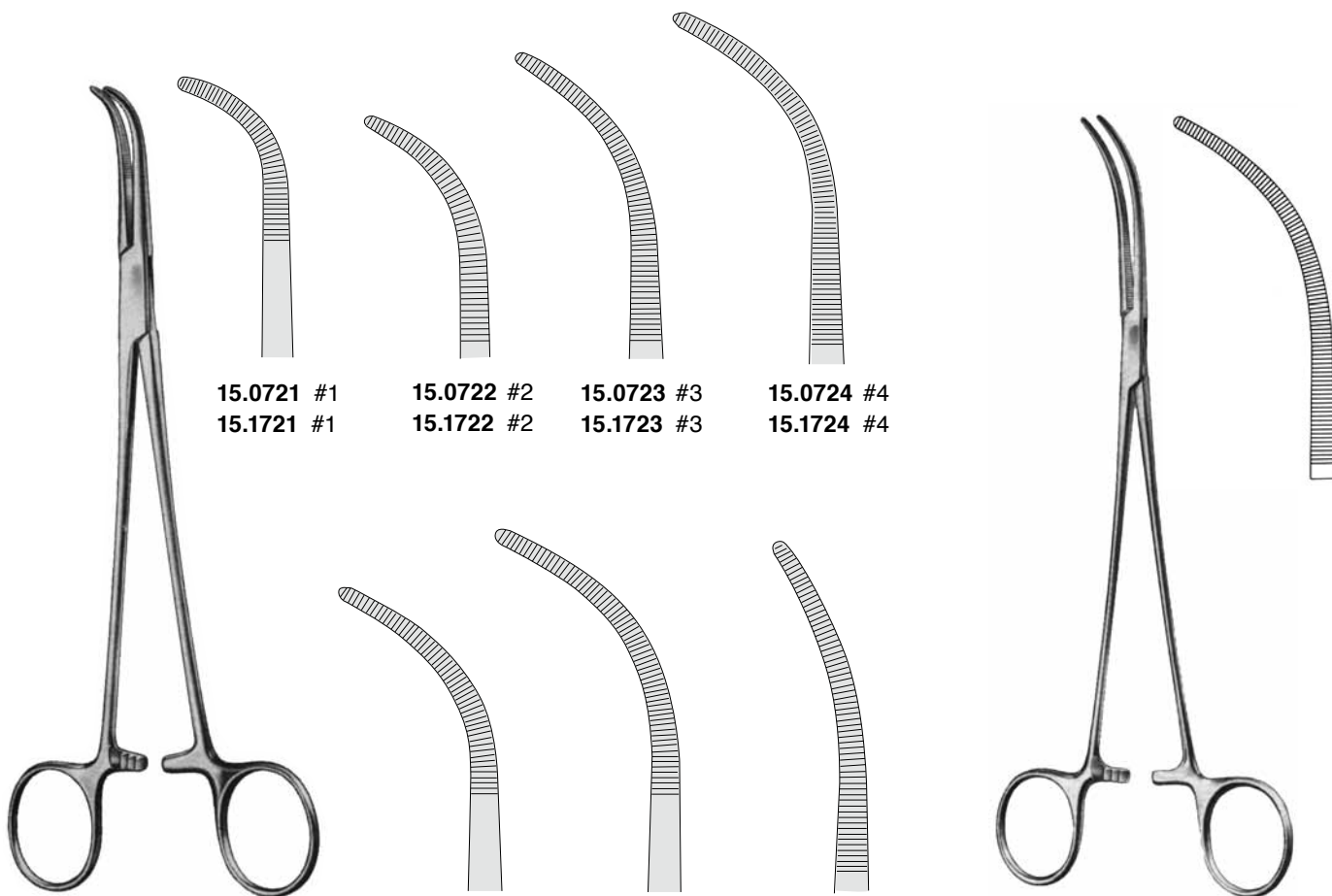

15.0721 #1

15.1721 #1

15.0722 #2

15.1722 #2

15.0723 #3

15.1723 #3

15.0724 #4

15.1724 #4

15.0725 #5

15.1725 #5

15.0726 #6

15.1726 #6

15.0727 #7

15.1727 #7

OVERHOLT-GEISSENDOERFER

15.0721-15.0727 21 cm

15.1721-15.1727 27 cm

OVERHOLT-MIXTER

15.0729 21 cm

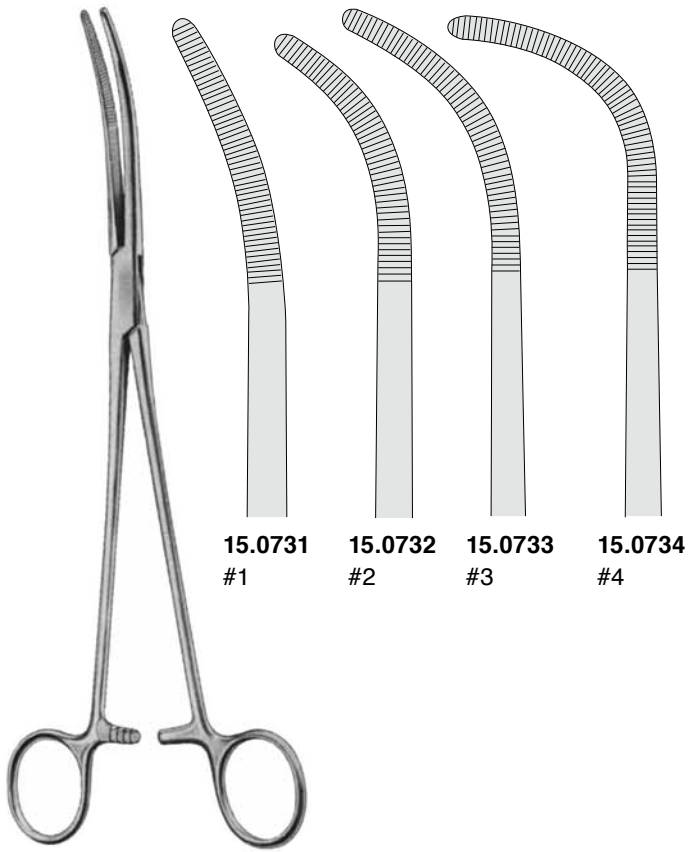

RUMEL
23 cm

15.0731 #1
 15.0732 #2
 15.0733 #3
 15.0734 #4



KANTROWITZ

15.0741 20 cm
 15.0743 24 cm
 15.0745 28 cm

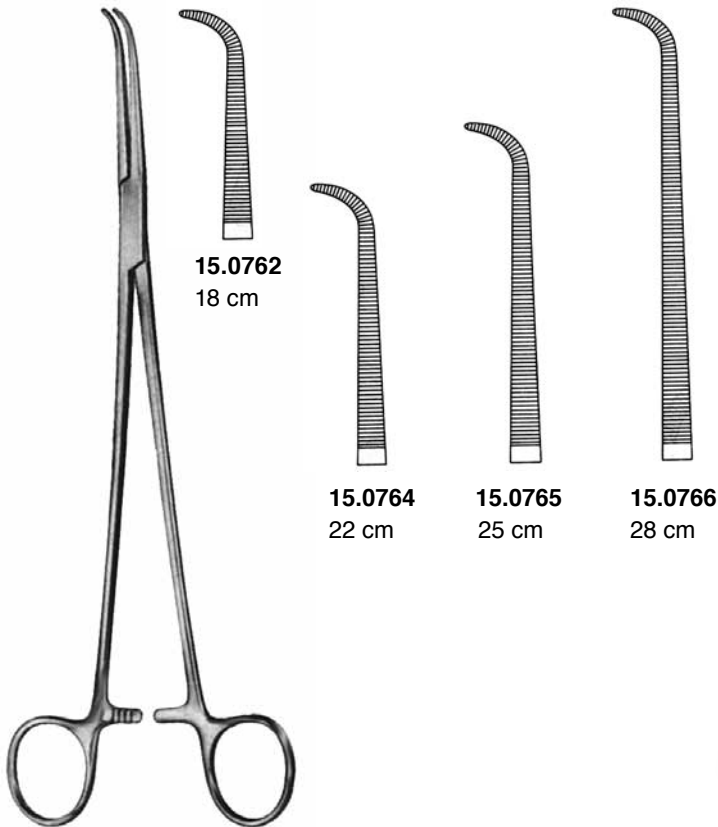

GEMINI-MINI

15.0762 18 cm
 15.0764 22 cm
 15.0765 25 cm
 15.0766 28 cm

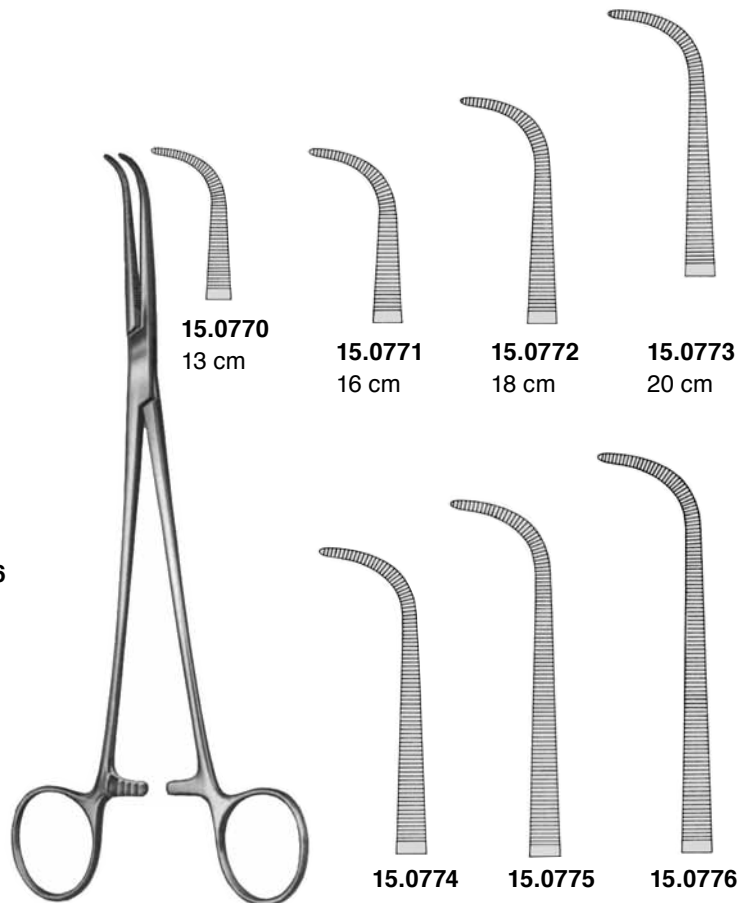

GEMINI

15.0770 13 cm
 15.0771 16 cm
 15.0772 18 cm
 15.0773 20 cm
 15.0774 23 cm
 15.0775 25 cm
 15.0776 28 cm

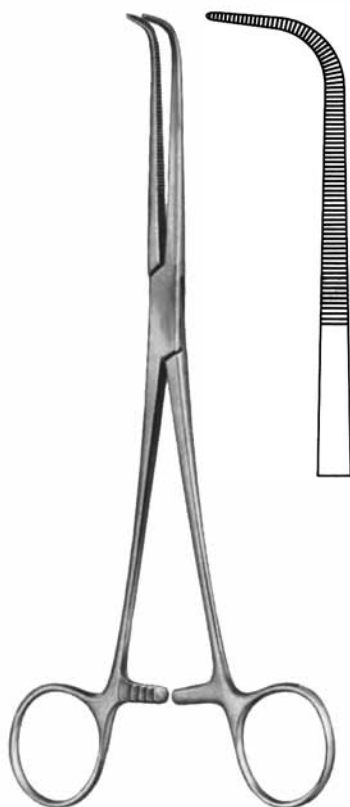

WIKSTROEM
 15.0780 21 cm
 15.0782 24 cm



LAWRENCE
 15.0784 28 cm



MEEKER
 15.0786 28 cm

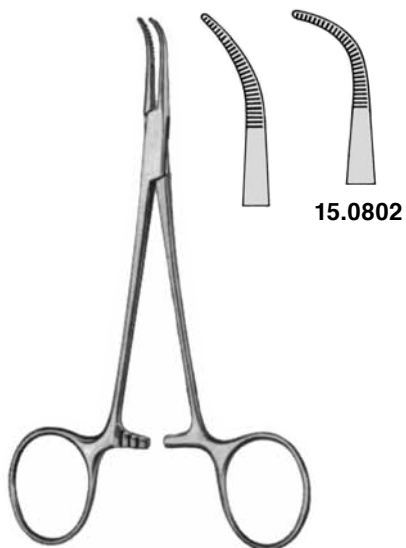

MIXTER-BABY
 15.0801 14,5 cm



MIXTER-BABY
 15.0803 18 cm

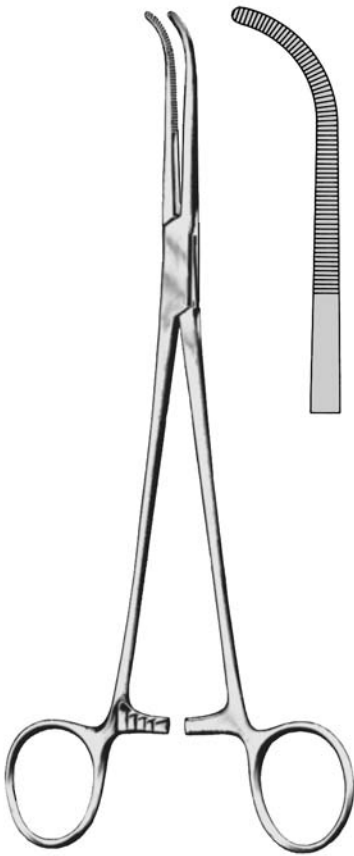

MIXTER
 15.0807 22 cm



MIXTER
 15.0809 23 cm

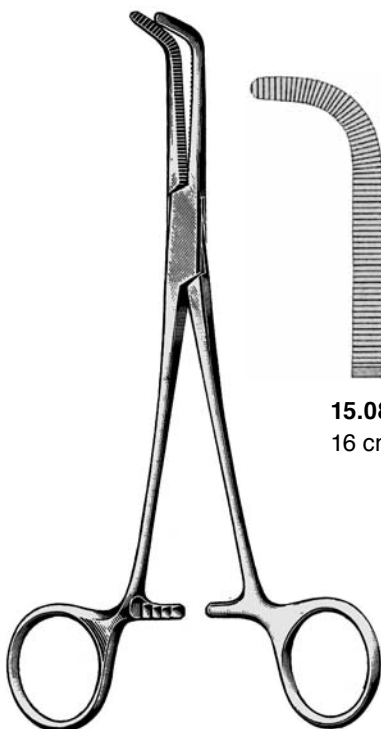

MIXTER

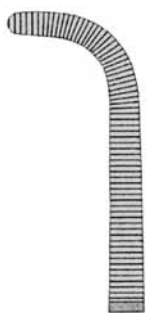

15.0811
 16 cm

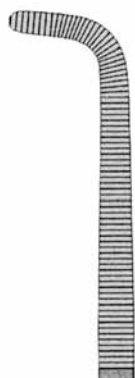

15.0813
 19 cm

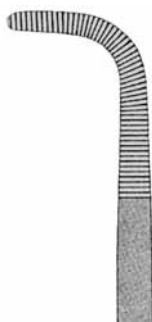

15.0817
 23 cm



MIXTER

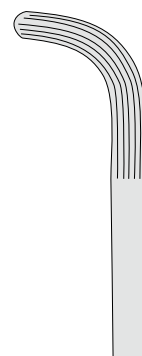

15.0831
 22 cm

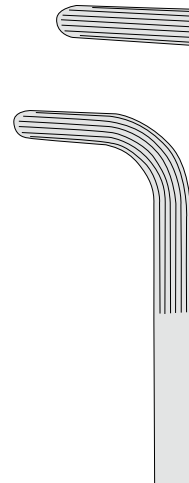

15.0833
 25 cm

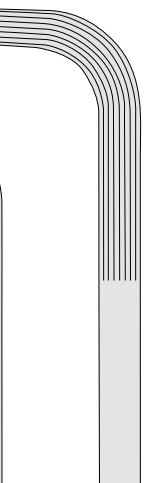

15.0835
 28 cm

Arterien- und Präparierklemmen
Hemostatic- and Dissecting Forceps
Pincès hémostatiques et à disséquer
Pinzas hemostáticas y para preparación
Pinze emostatiche e per preparazione



DEBAKEY-COLLIER
15.0269
36 cm

Arterien- und Präparierklemmen / Hemostatic- and Dissecting Forceps /
Pincas hémostatiques et à disséquer / Pinzas hemostáticas y para preparación /
Pinze emostatiche e per preparazione



ROCHESTER-PEAN
15.0478
36 cm



ROCHESTER-PEAN
15.0479
36 cm

Arterien- und Präparierklemmen / Hemostatic- and Dissecting Forceps /
Pincas hémostatiques et à disséquer / Pinzas hemostáticas y para preparación /
Pinze emostatiche e per preparazione



CRAFOORD-SELLORS
15.0499
36 cm



SAROT
15.0503
36 cm

Arterien- und Präparierklemmen / Hemostatic- and Dissecting Forceps /
Pincés hémostatiques et à disséquer / Pinzas hemostáticas y para preparación /
Pinze emostatiche e per preparazione



ROCH.-OCHSNER
15.0634
36 cm



ROCH.-OCHSNER
15.0635
36 cm

Arterien- und Präparierklemmen / Hemostatic- and Dissecting Forceps /
Pincas hémostatiques et à disséquer / Pinzas hemostáticas y para preparación /
Pinze emostatiche e per preparazione



GEMINI
15.0778
36 cm



GUYON
15.1936
36 cm



HARRINGTON
40.0705
36 cm



ALLIS
48.0019
36 cm
5 x 6

Arterien- und Präparierklemmen / Hemostatic- and Dissecting Forceps /
Pinces hémostatiques et à disséquer / Pinzas hemostáticas y para preparación /
Pinze emostatiche e per preparazione

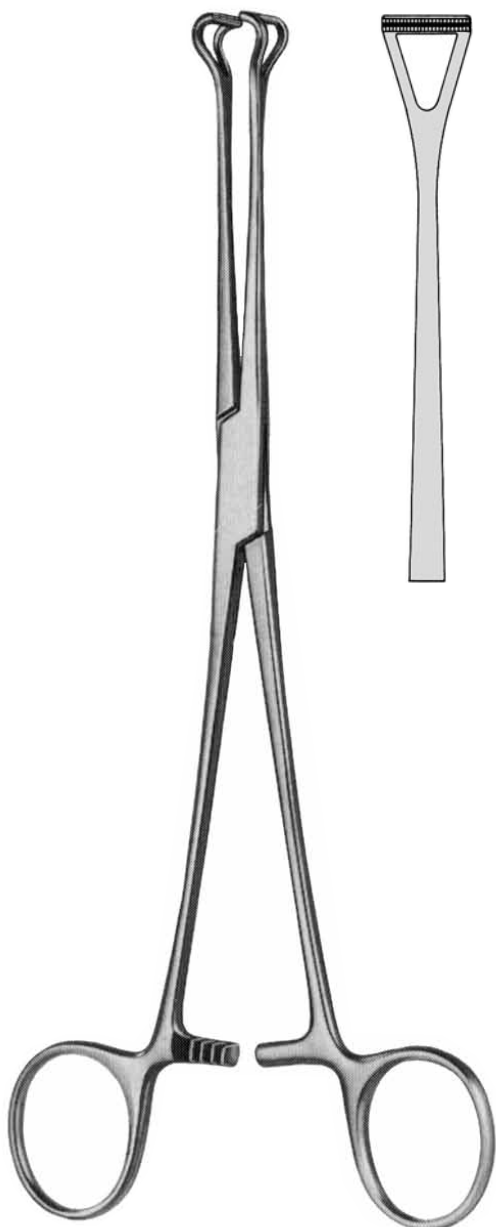

BABCOCK
48.0069
36 cm

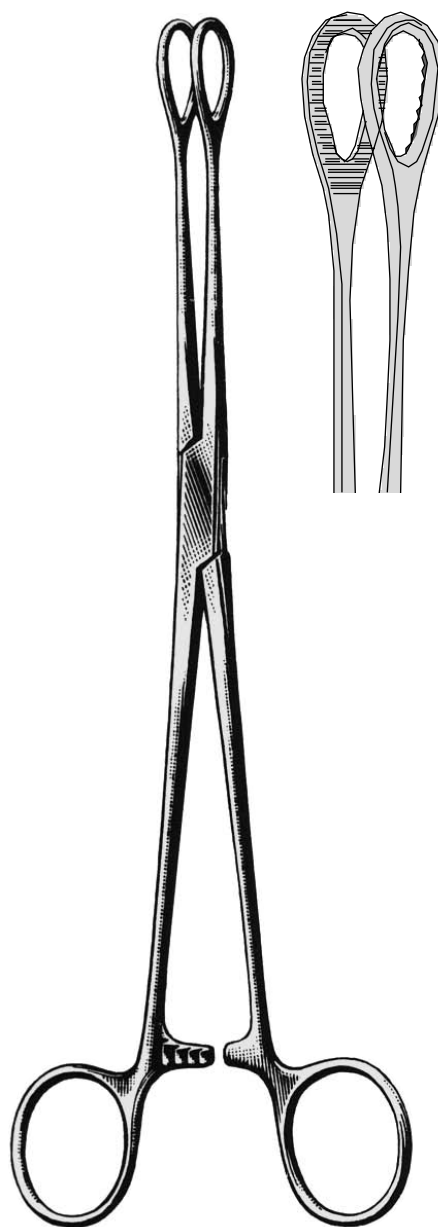

FOERSTER
16.0436
36 cm
gerieft
serrated
strié
estriada
con striatura

TUCH- UND SCHLAUCHKLEMMEN,
TUPFERZANGEN

TOWEL- AND TUBING CLAMPS,
DRESSING- AND SPONGE FORCEPS

PINCES A CHAMPS ET A TAMPONS,
PINCES PRESSE-TUBES

PINZAS DE CAMPO, PARA TUBOS
Y PARA TAMPONES

PINZE FISSATELI, PINZE SERRATUBI
PINZE PER TAMPONI





JONES
16.0010 5 cm
16.0012 9 cm



SCHAEDEL
16.0031 9 cm



OMBREDANNE (Jackson)
16.0150 13,5 cm

für Papiertücher
for paper drapes
pour champs en papier
para paños de papel
per fazzoletti di carta

mit Schlauchhalter
with tubeholder
avec clamp porte-tube
con porta-tubo
con porta-tubo



BACKHAUS
16.0100 9 cm
16.0102 11cm
16.0105 13 cm
16.0106 15 cm



BACKHAUS
16.0107 11 cm
16.0108 13 cm

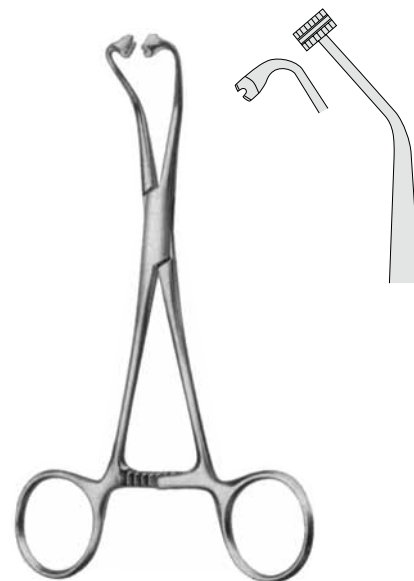

PEERS
16.0112 14,5 cm

für Papierabdeckung / for paper drapes / pour couverture en papier / para paños de papel / per copertura di carta



ROEDER

16.0115 13 cm
16.0116 15 cm

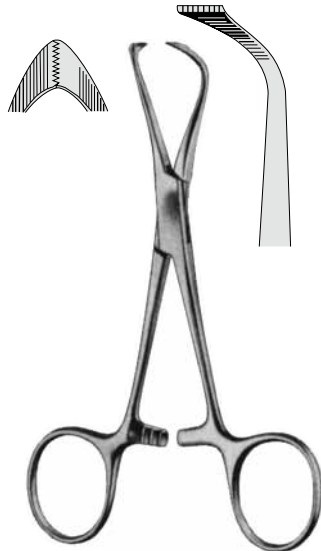

LORNA

16.0120 10 cm
16.0125 13 cm



BALL&SOCKET

16.0132 11 cm
16.0135 13 cm



TOHOKU

16.0140 10 cm
16.0145 13 cm

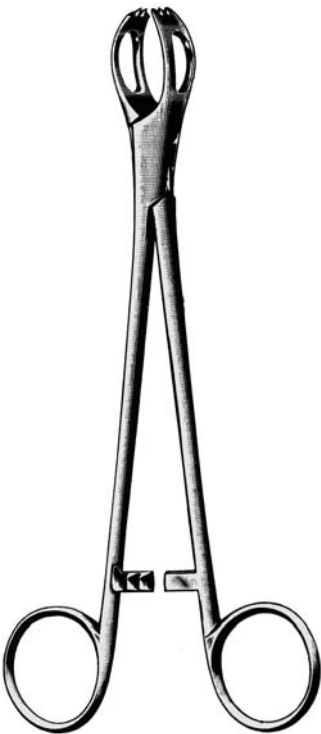

LANE

16.0160 15 cm
16.0164 20 cm



BERNHARD

16.0170 16,5 cm

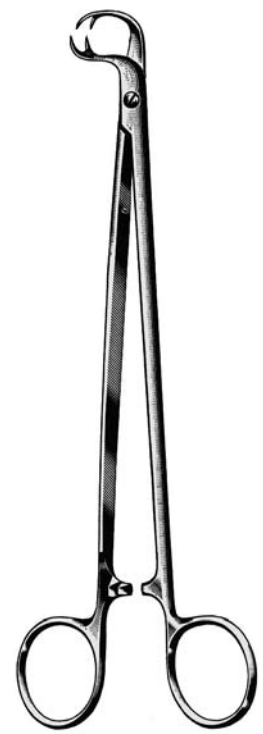

MOYNIHAN

16.0180 19 cm

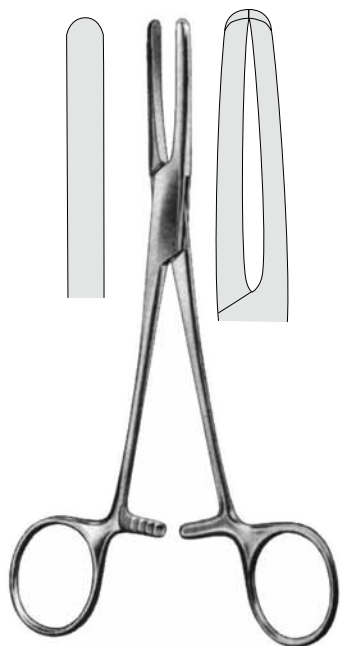

PRESBYTERIAN
16.0200 16 cm
16.0202 18 cm



KLINIK-BERLIN
16.0210 14,5 cm

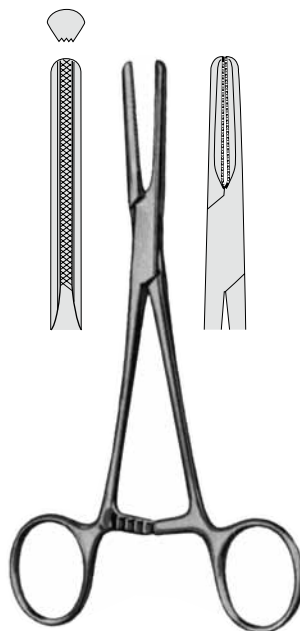

USA-MODEL
16.0220 16 cm
16.0222 18 cm
16.0224 20 cm

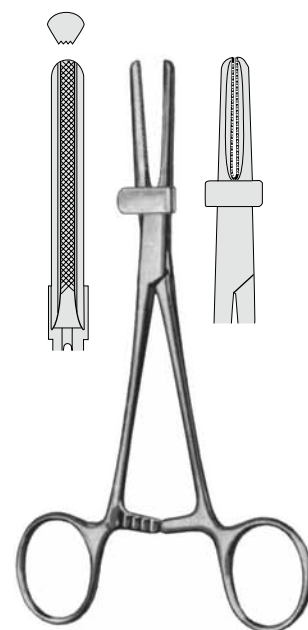

TUBING
16.0230 16 cm
16.0232 18 cm
16.0234 20 cm

Schlauchroller
Tube milking clamps
Pinces à traire les drains
Rodillos para tubos
Pinze pressa tubi con rulli



BROMPTON
16.0280 15,5 cm

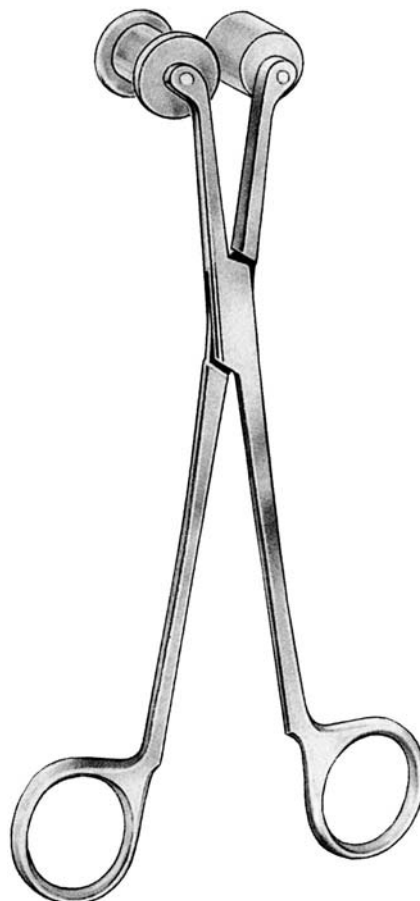

GUNNAR-HEY
16.0290 19 cm

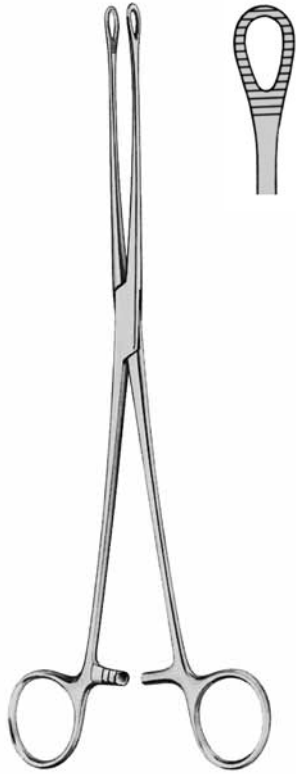

BERGMANN-FOERSTER
 16.0390 24 cm



BERGMANN-FOERSTER
 16.0391 24 cm

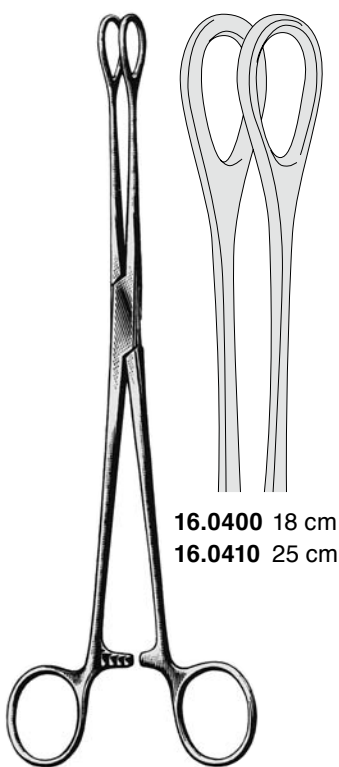

16.0400 18 cm
16.0410 25 cm

FOERSTER

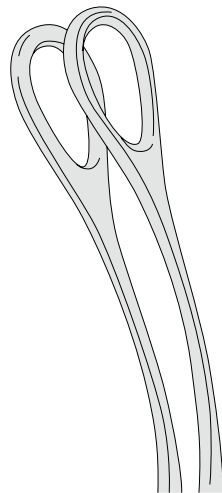

16.0401 18 cm
16.0411 25 cm

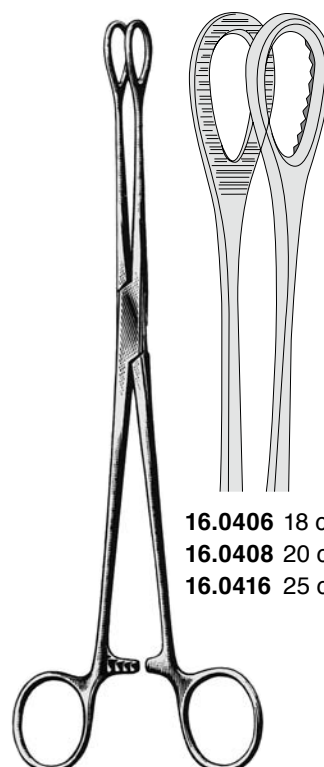

16.0406 18 cm
16.0408 20 cm
16.0416 25 cm

BALLENGER

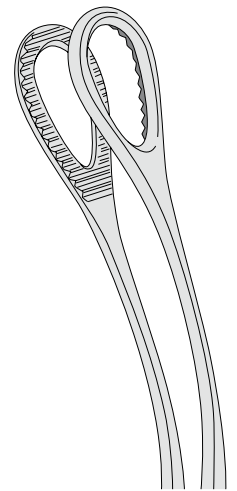

16.0407 18 cm
16.0409 20 cm
16.0417 25 cm



FOERSTER-DELIKAT
 25 cm

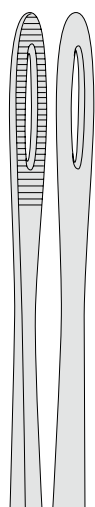

16.0418

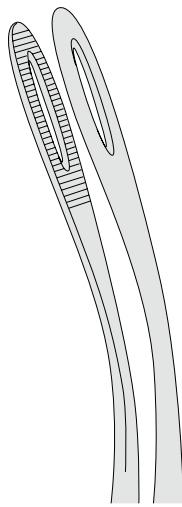

16.0419



RAMPLEY
 16.0420 25 cm

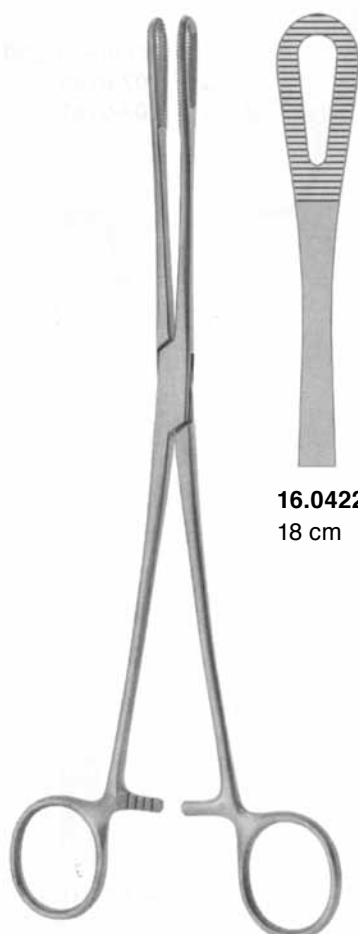

16.0422
 18 cm

RAMPLEY



16.0423
 25 cm



FLETCHER (Javerts)
 16.0424 24 cm



FLETCHER (Javerts)
 16.0425 24 cm

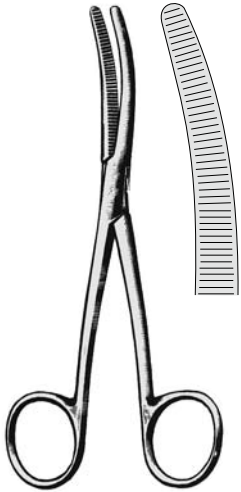

BRYANT
16.0300 13 cm



LISTER-SINUS
16.0360 13 cm
16.0362 16 cm
16.0364 18 cm

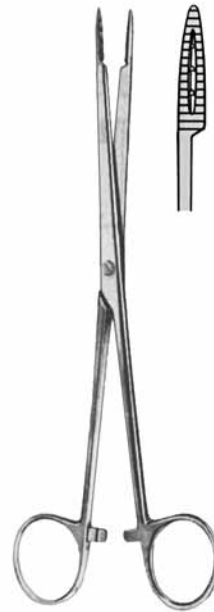

WALTON
16.0370 17 cm



WALTON
16.0371 17 cm

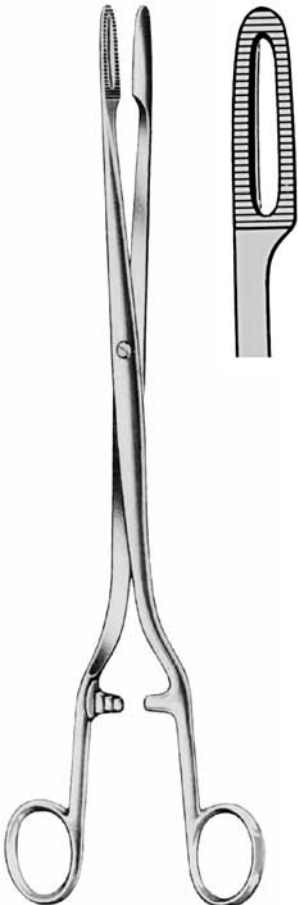

SIMS-MAIER
16.0426 28 cm

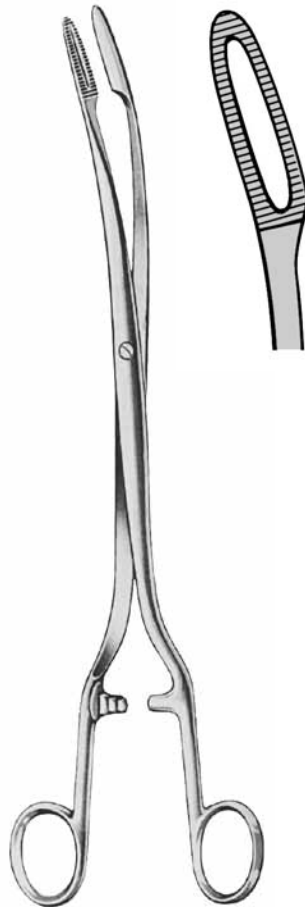

SIMS-MAIER
16.0427 28 cm



PELKMANN
16.0430 25 cm



PELKMANN
16.0431 25 cm



DUPLAY
 16.0440 20 cm

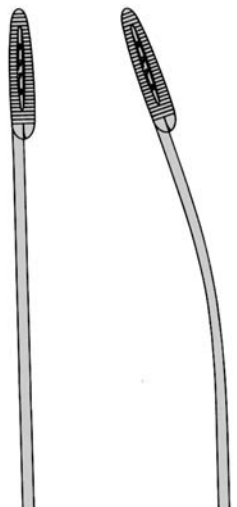

16.0441



GROSS
 16.0450 20 cm
 16.0452 22 cm
 16.0454 26 cm

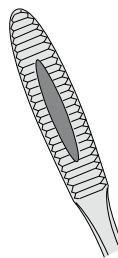

16.0451 20 cm
 16.0453 22 cm
 16.0455 26 cm

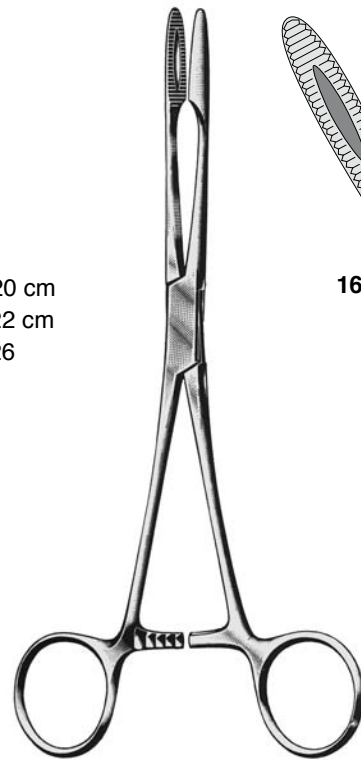

MAIER
 16.0460 25 cm

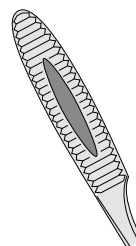

16.0461

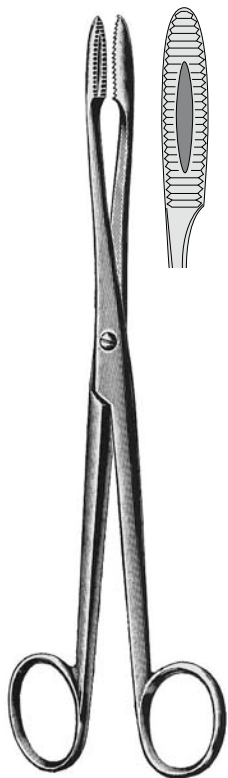

MAIER
 16.0462 25 cm

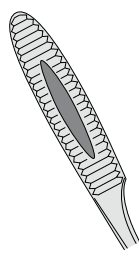

16.0463



EMMET
 16.0466 21 cm

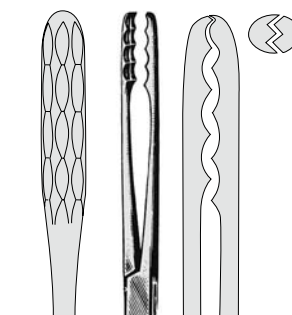

ULRICH
 16.0470 22 cm
 16.0472 25 cm

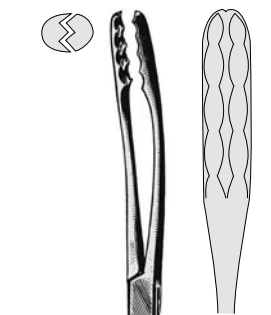

ULRICH
 16.0471 22 cm
 16.0473 25 cm

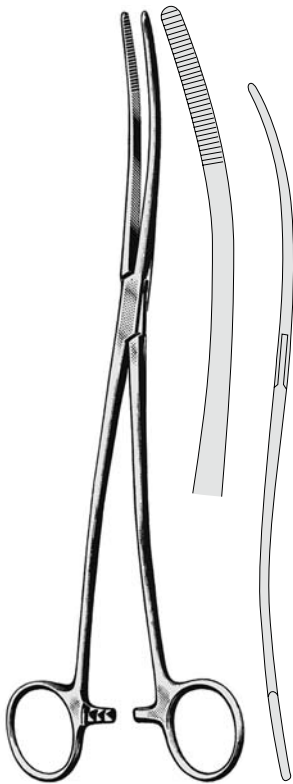

BOZEMANN

16.0500 26 cm

gerade /straight /droit /recto /retto

16.0501 26 cm

gebogen /curved / courbe /curvo /
curvo

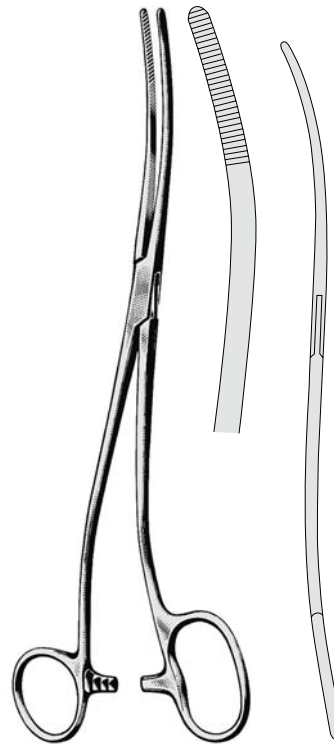

BOZEMAN-DOUGLAS

16.0505 25 cm



CHERON

16.0510 25 cm

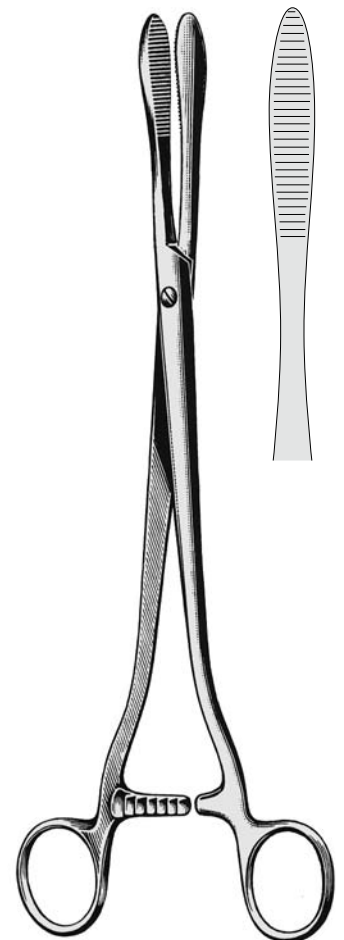

COLLIN

16.0520 25 cm

WUNDHAKEN
RETRACTORS
ECARTEURS
SEPARADORES
DIVARICATORI



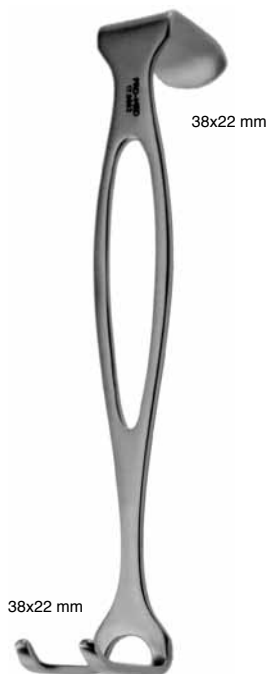

CZERNY
 17.0662 18 cm



MORRIS
 24cm
 17.0665 32x51/38x51 mm
 17.0666 44x51/51x51 mm
 17.0667 64x51/38x51 mm



GOELET
 17.0670 19 cm

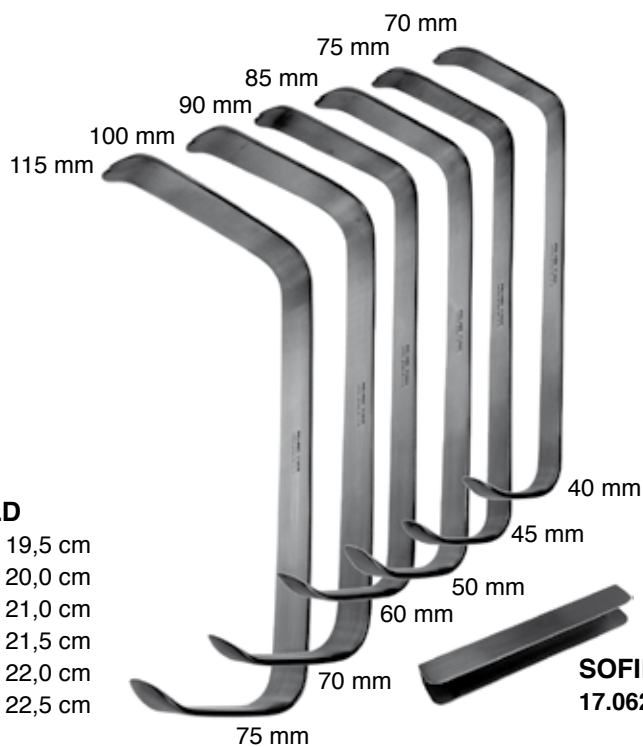

SOFIELD
 17.0621 19,5 cm
 17.0622 20,0 cm
 17.0623 21,0 cm
 17.0624 21,5 cm
 17.0625 22,0 cm
 17.0626 22,5 cm

SOFIELD
 17.0629



SOFIELD
 17.0620



WASSMUND
 17.0900 20 cm
 33 x 20 mm



OLLIER
 17.0912 22,5 cm
 36 x 60 mm

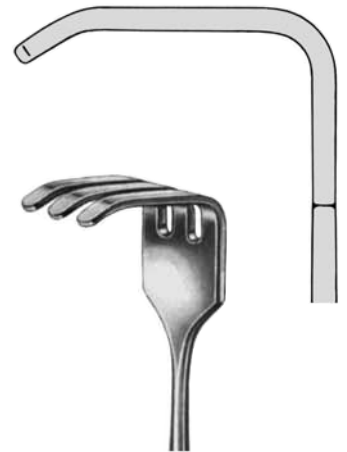

17.0910
 36 x 30 mm



KOERTE
 17.0922 24 cm
 stumpf
 blunt
 mousse
 romo
 smusso

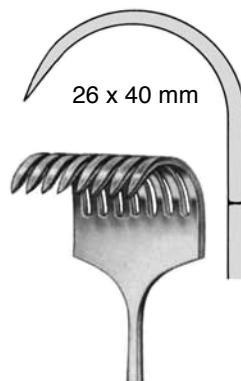

17.0920
 scharf
 sharp
 pointu
 agudo
 acuto



KOERTE
 17.0925
 23 cm
 stumpf
 blunt
 mousse
 romo
 smusso



ISRAEL
25 cm



17.0930
40 x 40 mm



17.0931
45 x 50 mm



17.0932
50 x 60 mm



17.0934
70 x 70 mm

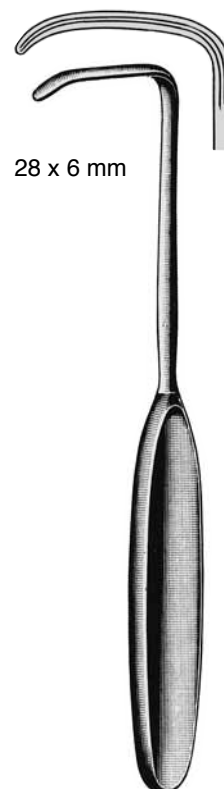

28 x 6 mm

LAHEY
17.1000 19 cm



12 x 14 mm

LITTLE
17.1010 20 cm



MIDDELDORPF

23 cm

17.1086 20 x 22 mm

17.1087 26 x 30 mm



GREEN

22 cm

17.1088 12 x 25 mm

Schilddrüsenhaken

Thyroid gland retractor

Ecarteur pour la thyroïde

Separador par la glándula tiroidea

Divaricatore per la tiroide



RICHARDSON

24 cm

17.1090 28 x 20 mm

17.1091 36 x 28 mm

17.1092 44 x 38 mm



49 x 38 mm

28 x 20 mm

36 x 28 mm

71 x 43 mm

RICHARDSON-EASTMANN

17.1097 Satz/Set/Jeu/Juego/Serie

17.1098 Klein/small/petit/chico/piccolo

17.1099 Groß/large/grand/grande/grande



KELLY

26 cm

17.1095 65 x 50 mm

17.1096 70 x 63 mm



KELLY

23,5 cm

17.1101 38 x 51 mm

17.1102 51 x 64 mm

25,5 cm

17.1103 64 x 76 mm

17.1104 76 x 89 mm



KELLY

26 cm

17.1118 160 x 38 mm

17.1119 160 x 57 mm

17.1093 190 x 38 mm

17.1094 190 x 57 mm

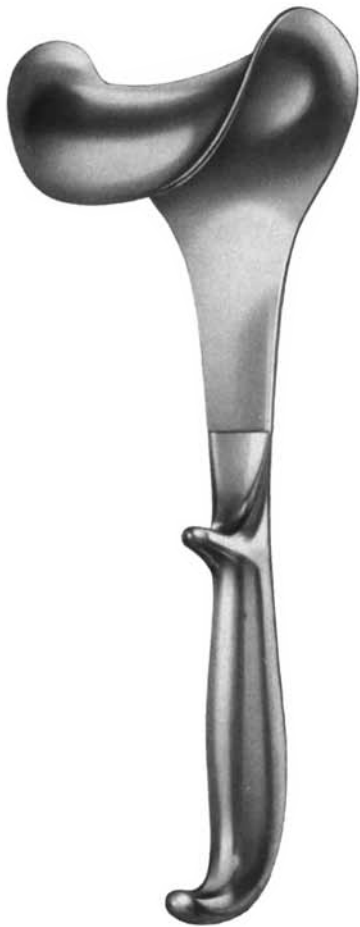

DOYEN
25 cm
17.1100 85 x 50 mm

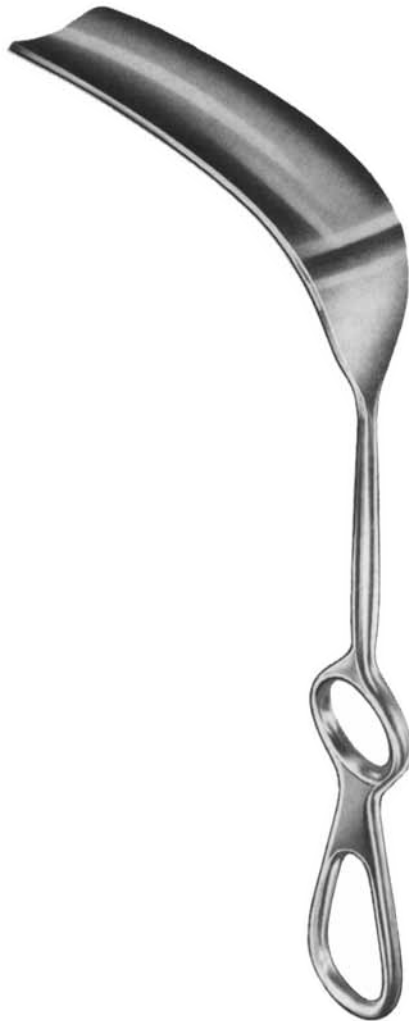

DOYEN-STILLE
20 cm
17.1105 90 x 28 mm
17.1106 105 x 30 mm
17.1107 120 x 52 mm



MORRIS
21 cm
17.1108 38 x 51 mm
17.1109 51 x 51 mm
17.1110 64 x 51 mm



FRITSCH

24 cm

- 17.1120 35 x 40 mm
- 17.1121 45 x 40 mm
- 17.1122 45 x 50 mm
- 17.1123 45 x 60 mm
- 17.1124 55 x 75 mm
- 17.1125 65 x 80 mm



KOCHER-WAGNER

28 cm

- 17.1130 22 x 15 mm
- 17.1131 38 x 20 mm
- 17.1132 67 x 25 mm
- 17.1133 100 x 35 mm



TUEBINGEN

- 17.1154 28 cm
95 x 20 mm



DEAVER
17.1273C-17.1279C

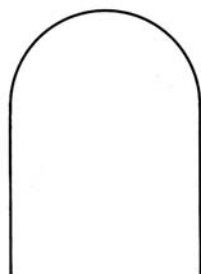

17.1273C
300 x 25 mm

17.1274C
330 x 25 mm

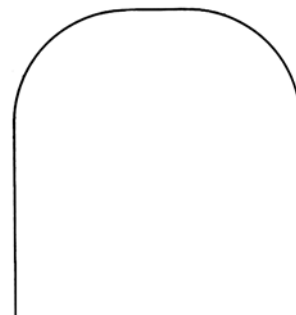

17.1276C
330 x 38 mm

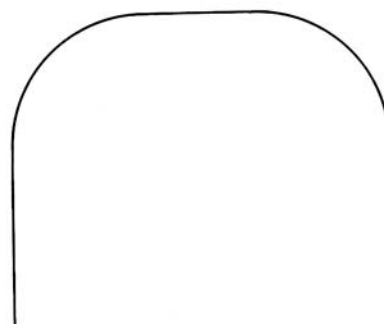

17.1277C
330 x 50 mm

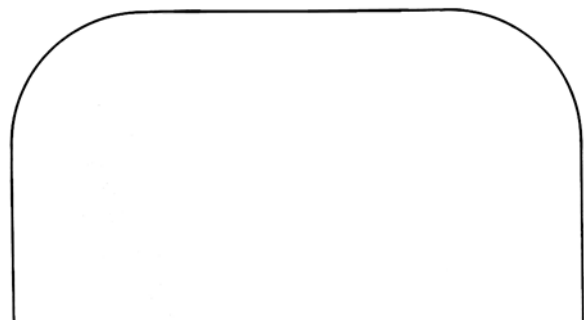

17.1278C
330 x 75 mm

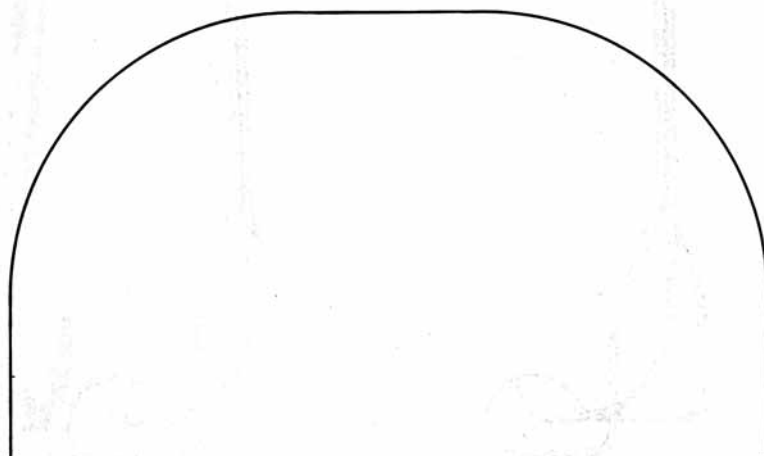

17.1279C
330 x 100 mm



DEAVER
17.1270
180 x 19 cm

DEAVER
17.1271
215 x 22 mm

DEAVER
17.1272
230 x 25 mm

DEAVER
17.1273
300 x 25 mm

DEAVER
17.1274
330 x 25 mm

DEAVER
17.1275
360 x 25 mm



DEAVER
17.1276 300 x 38 mm



DEAVER
17.1277 300 x 50 mm



DEAVER
17.1278 300 x 75 mm
17.1279 330 x 100 mm



CUSHING
17.0576
36 cm
11x12 mm



DEAVER
17.1275
36cm / 25 mm



DEAVER
17.1275.36
36 cm / 65 mm

WUNDSPEIZER
RETRACTORS, SELF-RETAINING
ECARTEURS AUTOSTATIQUES
SEPARADORES AUTOSTATICOS
DIVARICATORI AUTOSTATICI

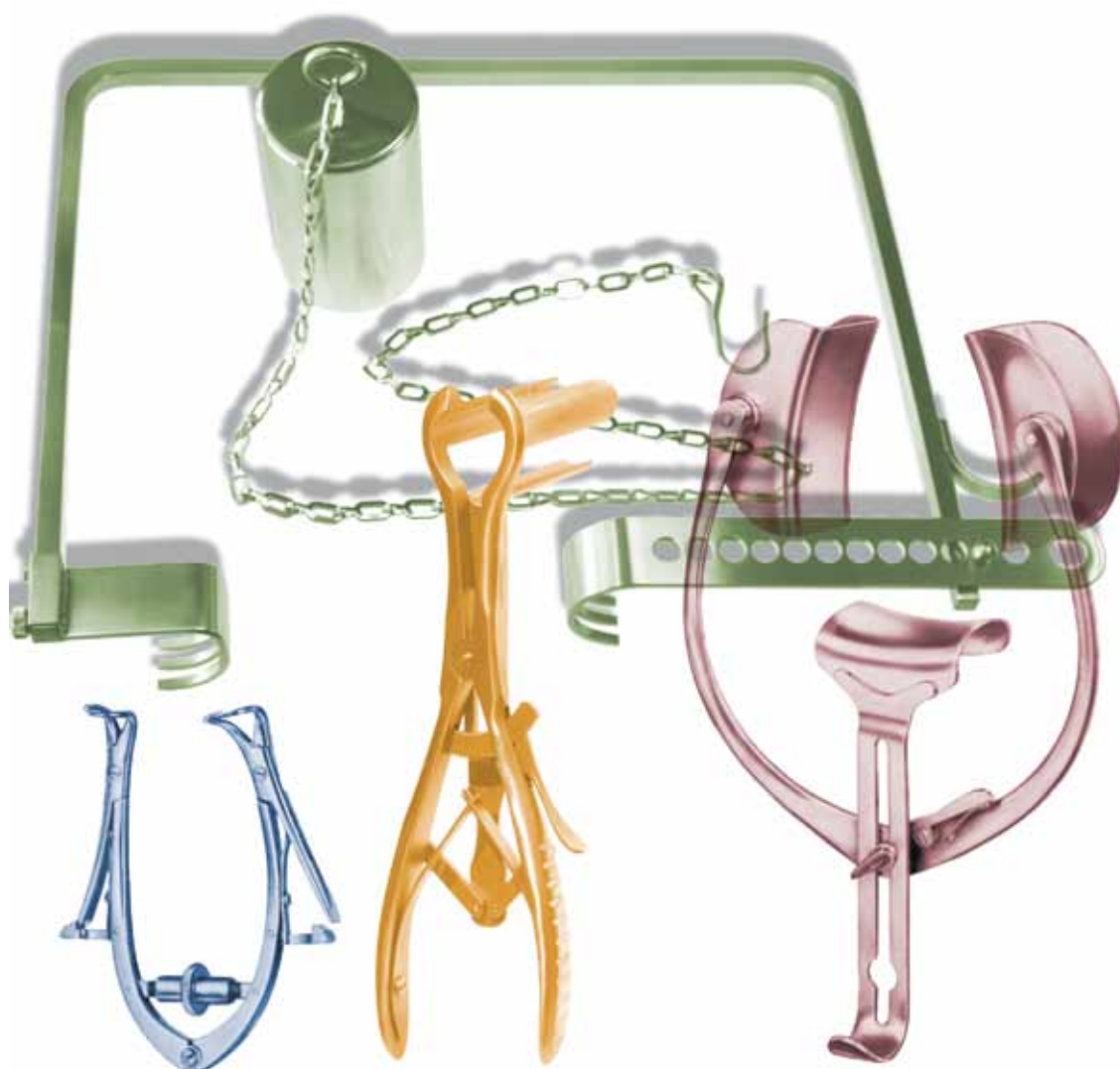

76x40 64x25 mm



DARLING
17.5670 18 cm

64x25 76x40 mm



DARLING
17.5672 18 cm



DEBAKEY-FEMUR
17.5890
10 cm

Kinder
children
enfants
niños
bambini



DEBAKEY-FEMUR
17.5892
14,5 cm



JOLL (FRIEDMANN)
55.0500
10 cm

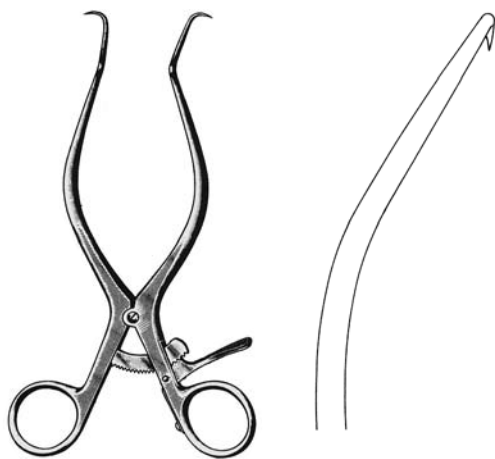

GELPI-MINI
17.5899 10 cm



GELPI-BABY
17.5900 14 cm



GELPI
18 cm
17.5901 spitz / sharp / pointu / agudo / acuto
17.5902 stumpf / blunt / mousse / romo / smusso

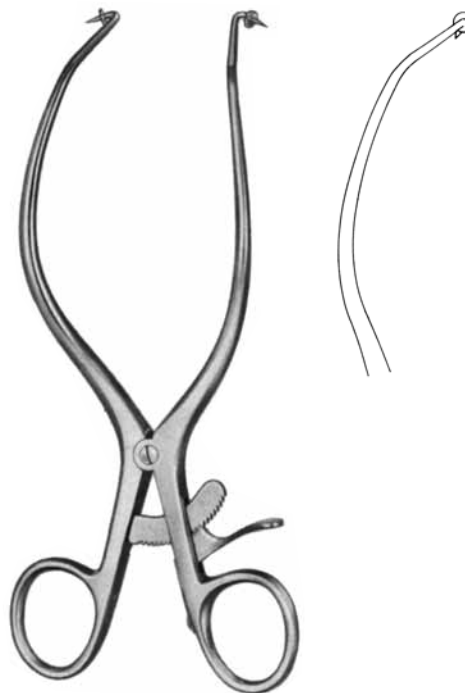

GELPI
17.5905 18 cm



GELPI-SELETZ
17.5907 15 cm

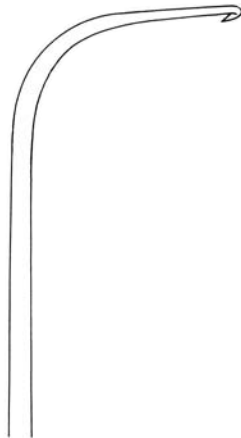

JACKSON-BURROWS
17.5908 18,5 cm

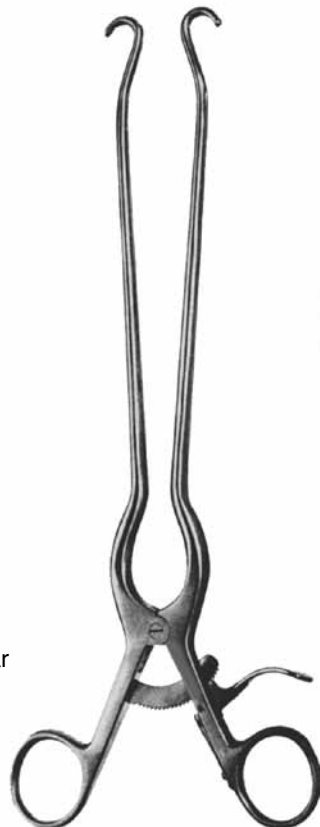

MORRIS-MITRAL
40.3400
16 cm



GELPI-ORTHO
17.5906
30 cm

Gefäßwundspreizer
Vascular Retractor
Ecarteur vasculaire
Separador vascular
Divaricatore vascolar

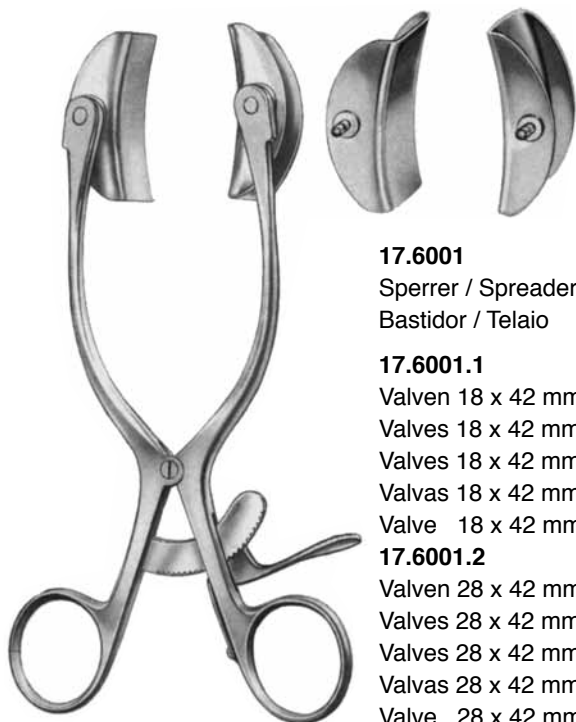

17.6001
 Sperrer / Spreader / Cadre /
 Bastidor / Telaio

17.6001.1
 Valven 18 x 42 mm (Paar)
 Valves 18 x 42 mm (Pair)
 Valves 18 x 42 mm (Paire)
 Valvas 18 x 42 mm (Par)
 Valve 18 x 42 mm (Paio)

17.6001.2
 Valven 28 x 42 mm (Paar)
 Valves 28 x 42 mm (Pair)
 Valves 28 x 42 mm (Paire)
 Valvas 28 x 42 mm (Par)
 Valve 28 x 42 mm (Paio)

COLLIN-BABY

17.6000 18 cm

bestehend aus:

- 17.6001 Rahmen
- 17.6001.1 1 Paar Valven 18x42 mm
- 17.6001.2 1 Paar Valven 28x42 mm

consisting of:

- 17.6001 Frame
- 17.6001.1 Blades 18x42 mm (Pair)
- 17.6001.2 Blades 28x42 mm (Pair)

comprenant:

- 17.6001 cadre seul
- 17.6001.1 valves 18x42 mm (paire)
- 17.6001.2 valves 28x42 mm (paire)

compuetso de:

- 17.6001 bastidor suelto
- 17.6001.1 valvas 18x42 mm (par)
- 17.6001.1 valvas 28x42 mm)

composto da:

- 17.6001 Telaio solo
- 17.6001.1 valve 18x42mm (par)
- 17.6001.2 valve 28x42 mm (par)



COLLIN
17.6002 22 cm
 38 x 60 mm

Valven / Lateral blades / valves latérales
 / valvas laterales / valve laterali 38 x
 60 mm



COLLIN
 22 cm
17.6003
 Seitenvlaven / Lateral blades / valves
 latérales / valvas laterales / valve
 laterali 38 x 60 mm

Mittelvalve / center blade / valve
 central / valva centrale / valva
 centrale 38 x 55 mm

17.6004
 Seitenvlaven / Lateral blades / valves
 latérales / valvas laterales / valve
 laterali 38 x 80 mm

Mittelvalve / center blade / valve
 central / valva centrale / valva
 centrale 50 x 75 mm



COLLIN-LOCKTITE

17.6007 26 cm

60 x 80 mm

Seitenvalven / Lateral blades /
 valves latérales / valvas laterales /
 valve laterali 60 x 80 mm

Mittelvalve / center blade /
 valve central / valva centrale /
 valva centrale 60 x 75 mm

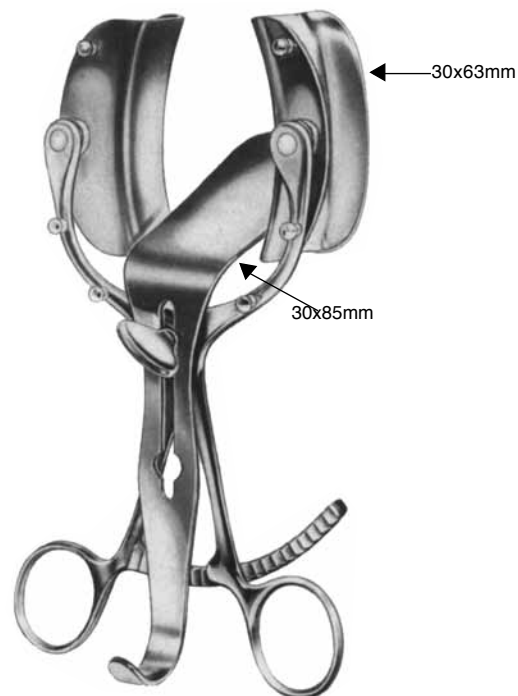

LEGUEU

17.6010 18 cm



MAYO-ADAMS

17.6015 17 cm



HOLZBACH
17.6020



RICARD

17.6030 28 cm

Mittelvalve 55x70mm, Seitenvlaven 50x58mm
Centervalue 55x70, lateral blades 50x58 mm
valve centrale 55x70, valves latérales 50x58mm
valva central 55x70, valvas laterales 50x58mm
valva centrale 55x70, valve laterali 50x58mm

17.6035 30 cm

Mittelvalve 80x90mm, Seitenvlaven 60x80mm
Centervalue 80x90, lat. blades 60x80 mm
valve centrale 80x90, valves latérales 60x80mm
valva central 80x90, valvas laterales 60x80mm
valva centrale 80x90, valve laterali 60x80mm



ROBIN-MASSE

17.6040 21cm

Mittelvalve 40x64mm, Seitenvlaven 38x62mm
 Centervlaven 40x64, lat. blades 38x62 mm
 valve centrale 40x64, valves latérales 38x62mm
 valva central 40x64, valvas laterales 38x62mm
 valva centrale 40x64, valve laterali 38x62mm

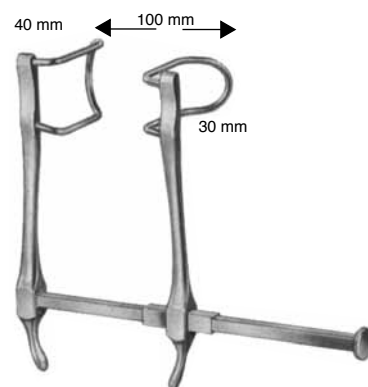

GOSSET

17.6100 100 mm

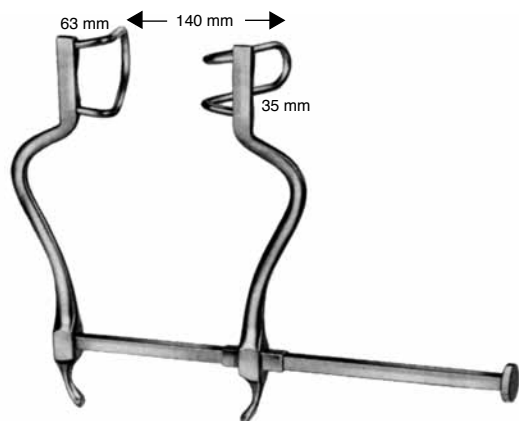

GOSSET

17.6101 140mm

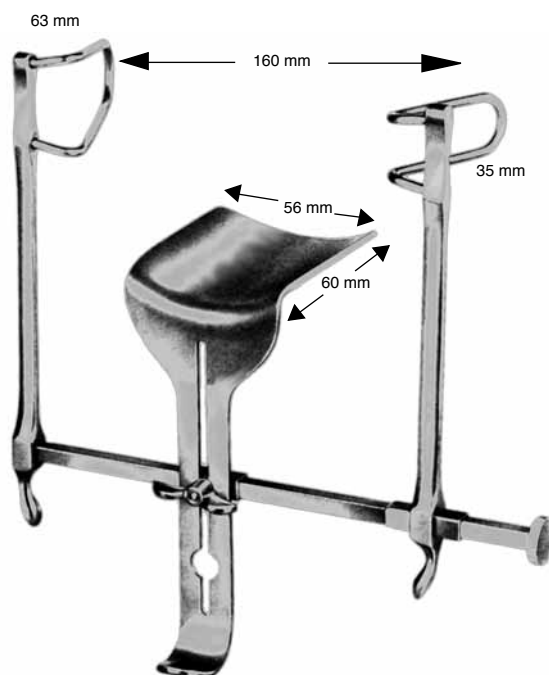

GOSSET

17.6102 160mm

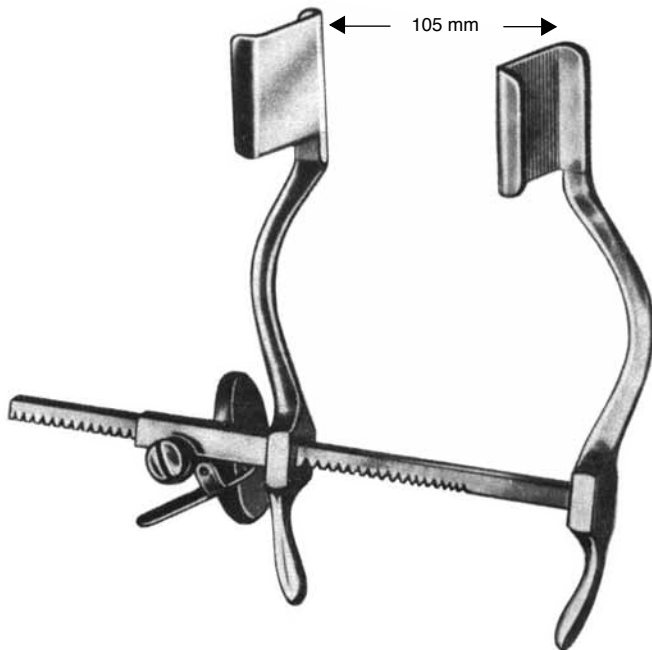

HERTZLER
 17.6110

Spreizweite / spread / écartement / abertura / apertura 105 mm
 Tiefe, Breite / Depth, Width / profondeur, largeur /
 profundidad, ancho / profondità, larghezza : 25 x 25 mm



BALFOUR-BABY
 17.6150 90 mm

Spreizweite / spread / écartement / abertura / apertura 90 mm

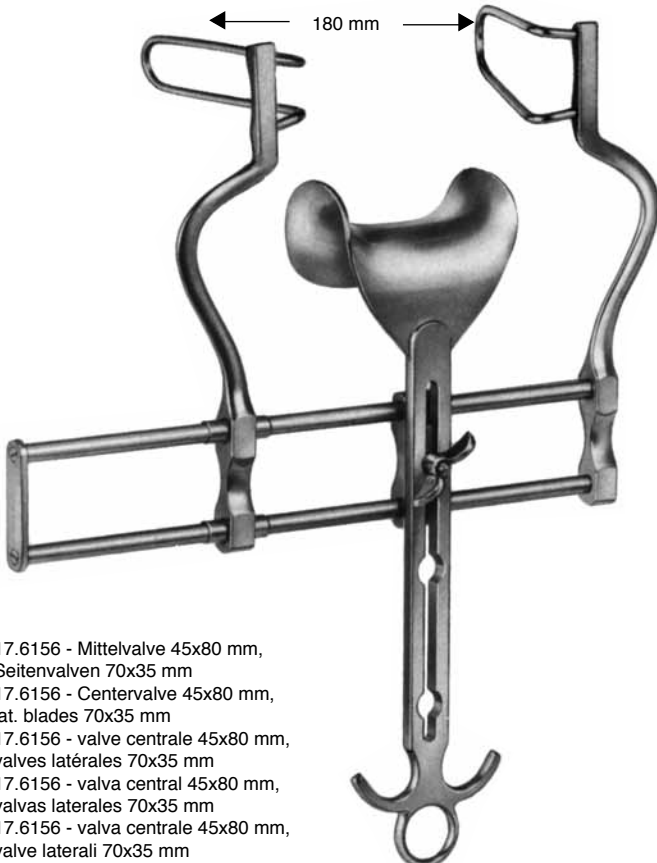

17.6156 - Mittelvalve 45x80 mm,
 Seitenvlaven 70x35 mm
 17.6156 - Centervlaven 45x80 mm,
 lat. blades 70x35 mm
 17.6156 - valve centrale 45x80 mm,
 valves latérales 70x35 mm
 17.6156 - valva central 45x80 mm,
 valvas laterales 70x35 mm
 17.6156 - valva centrale 45x80 mm,
 valve laterali 70x35 mm

BALFOUR
 17.6152 180 mm

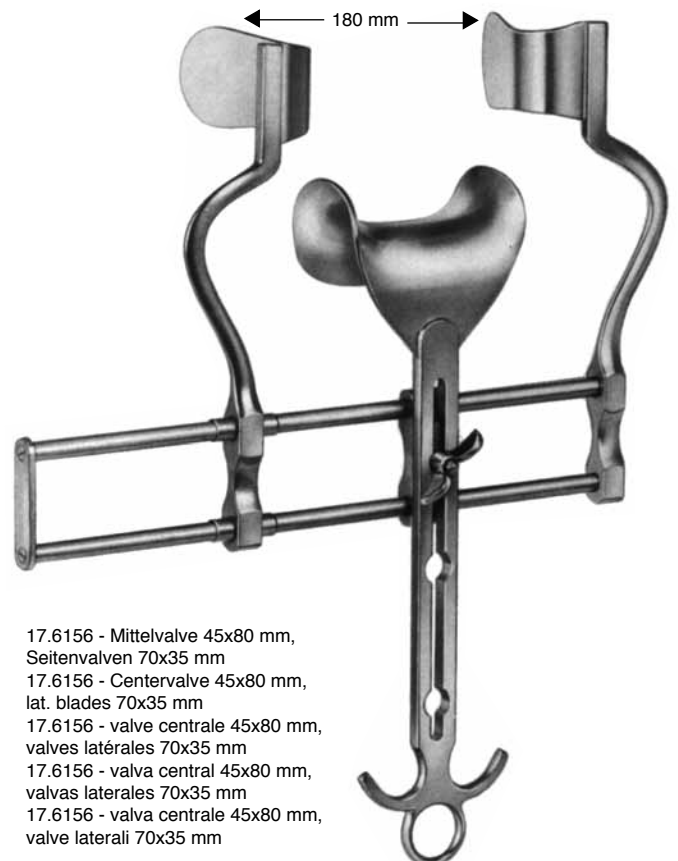

17.6156 - Mittelvalve 45x80 mm,
 Seitenvlaven 70x35 mm
 17.6156 - Centervlaven 45x80 mm,
 lat. blades 70x35 mm
 17.6156 - valve centrale 45x80 mm,
 valves latérales 70x35 mm
 17.6156 - valva central 45x80 mm,
 valvas laterales 70x35 mm
 17.6156 - valva centrale 45x80 mm,
 valve laterali 70x35 mm

BALFOUR
 17.6153 180 mm

- 17.6158 - Mittelvalve 70x85, Seitenvalven 100x35 mm
- 17.6158 - Centervalue 70x85, lateral blades 100x35 mm
- 17.6158 - valve centrale 70x85, valves latérales 100x35 mm
- 17.6158 - valva central 70x85, valvas laterales 100x35 mm
- 17.6158 - valva centrale 70x85, valve laterali 100x35 mm

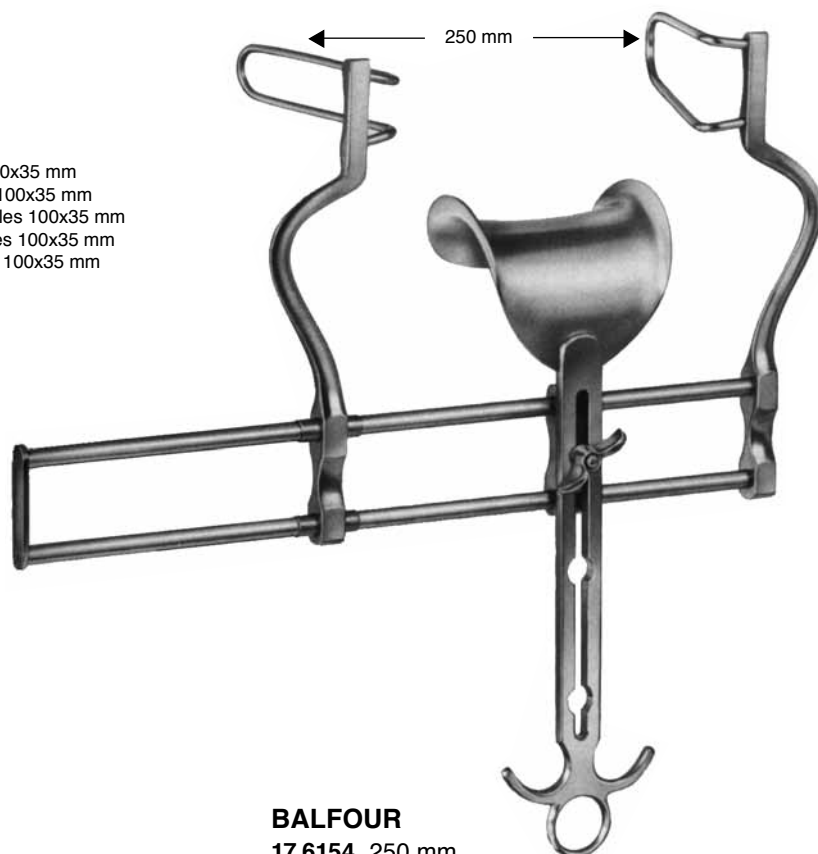

BALFOUR
 17.6154 250 mm

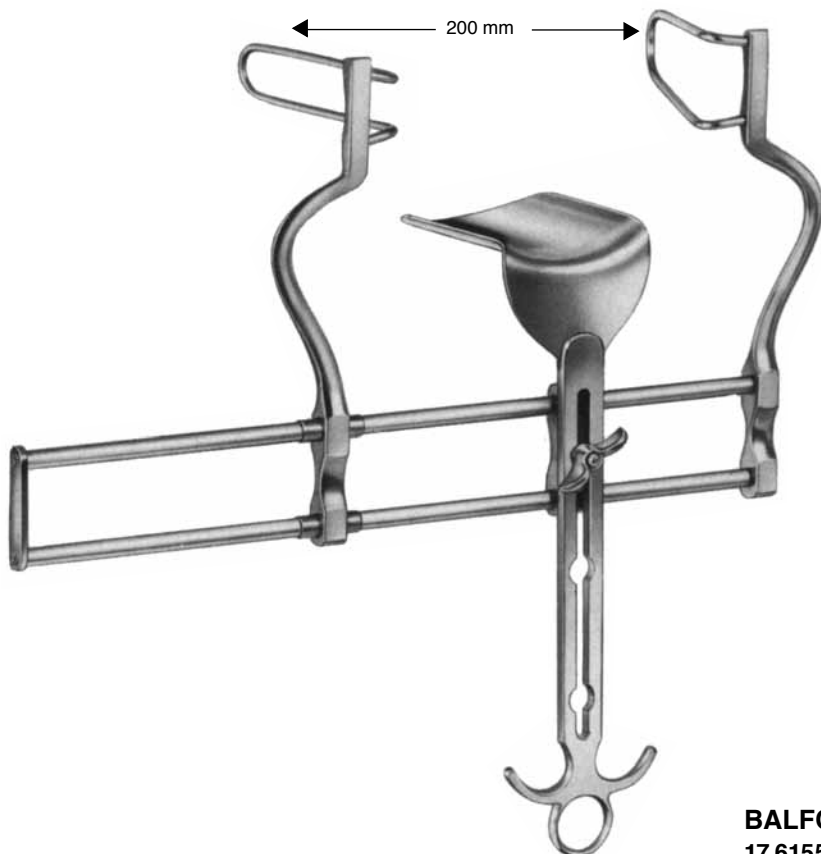

- 17.6157 - Mittelvalve 100x70mm,Seitenvalven 100x35 mm
- 17.6157 - Centervalue 100x70, lateral blades 100x35 mm
- 17.6157 - valve centrale 100x70, valves latérales 100x35 mm
- 17.6157 - valva central 100x70, valvas laterales 100x35 mm
- 17.6157 - valva centrale 100x70, valve laterali 100x35 mm

BALFOUR
 17.6155 200 mm



17.6174
 Paar/Pair
 Pair/Par
 Paio 89x45mm

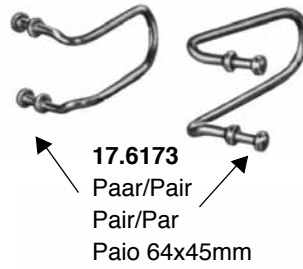

17.6173
 Paar/Pair
 Pair/Par
 Paio 64x45mm

17.6178L
 Seitenarm links
 4th blade attachment left
 Bras latéral à gauche
 Brazo lateral izquierdo
 Braccio lateral sinistra

17.6178R
 Seitenarm rechts
 4th blade attachment right
 Bras latéral à droite
 Brazo lateral derecho
 Braccio lateral destra

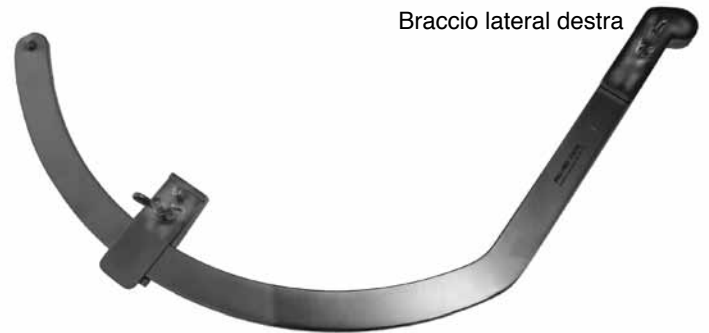

BALFOUR
17.6178L
17.6178R

BALFOUR-Modif.
17.6170 200 mm
17.6172 265 mm
 komplett/complete/
 complet/completo/completo

Mittelvalven für Bauchdeckenhalter
 Center blades
 Valves centrales
 Valvas centrales
 Valve centrali



BALFOUR
17.6156 45 x 80 mm
17.6158 70 x 85 mm
17.6159 80 x 90 mm

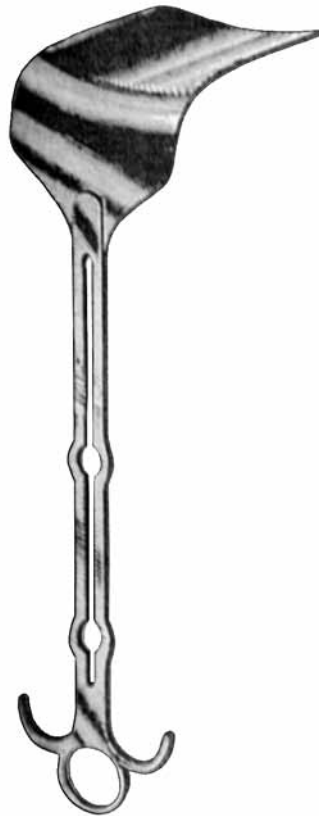

BALFOUR
17.6157 100 x 70 mm



HORGAN
17.6176 51 x 198 mm

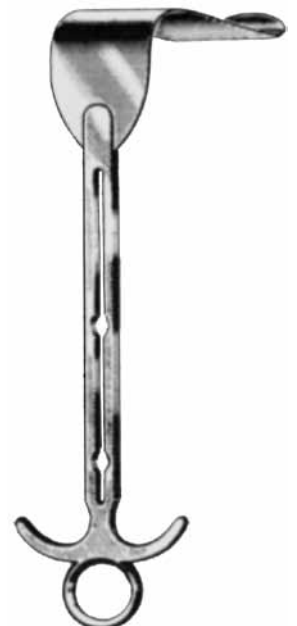

HORGAN
17.6177 51 x 127 mm

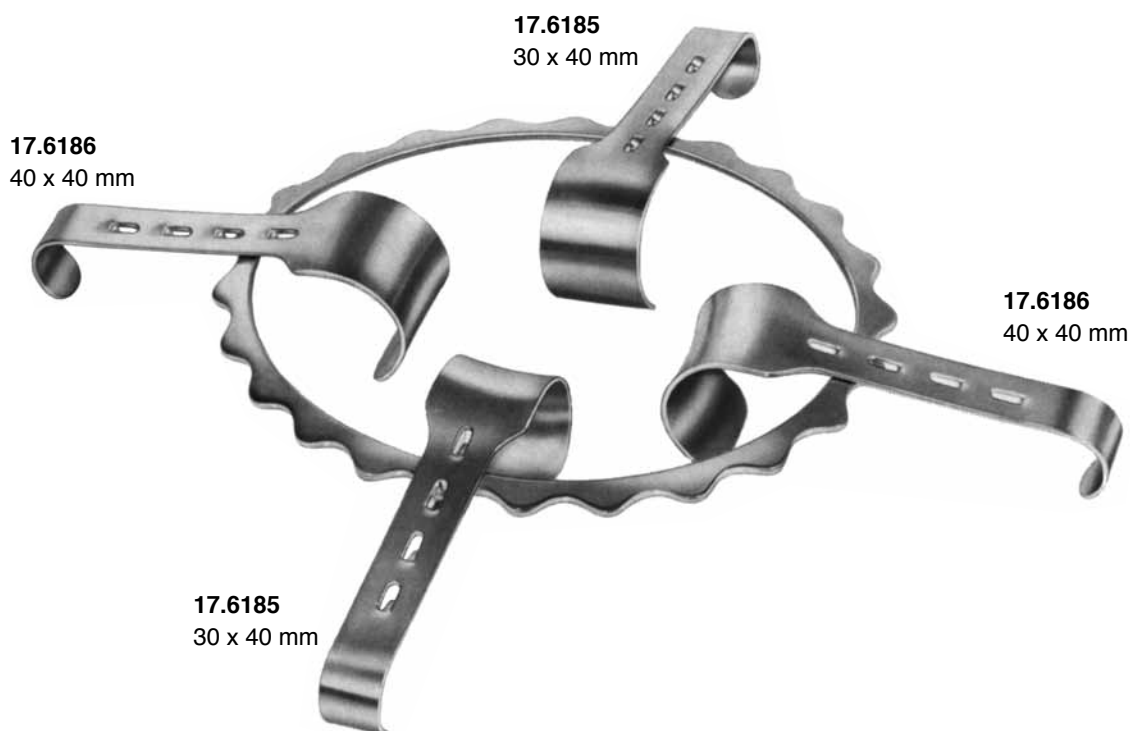

DENIS-BROWN

17.6180 für Kinder, bestehend aus:
 17.6181 Rahmen 180x150 mm
 17.6185 2 Valven 30x40 mm
 17.6186 2 Valven 40x40 mm

for children, consisting of:
 17.6181 Frame 180x150 mm
 17.6185 2 valves 30x40 mm
 17.6186 2 valves 40x40 mm

pour enfants, comprenant:
 17.6181 cadre 180x150 mm
 17.6185 2 valves 30x40 mm
 17.6186 2 valves 40x40 mm

para niños, compuesto de:
 17.6181 cuadro 180x150 mm
 17.6185 2 valvas 30x40 mm
 17.6186 2 valvas 40x40 mm

per bambini, composto da:
 17.6181 telaio 180x150 mm
 17.6185 2 valve 30x40 mm
 17.6186 2 valve 40x40 mm

DENIS-BROWN

17.6182 für Erwachsene, bestehend aus:
 17.6183 Rahmen 255x180 mm
 17.6185 2 Valven 30x40 mm
 17.6186 2 Valven 40x40 mm

for adults, consisting of:
 17.6183 Frame 255x180 mm
 17.6185 2 valves 30x40 mm
 17.6186 2 valves 40x40 mm

pour adultes, comprenant:
 17.6183 cadre 255x180 mm
 17.6185 2 valves 30x40 mm
 17.6186 2 valves 40x40 mm

para adultos, compuesto de:
 17.6183 cuadro 255x180 mm
 17.6185 2 valvas 30x40 mm
 17.6186 2 valvas 40x40 mm

per adulti, composto da:
 17.6183 telaio 255x180 mm
 17.6185 2 valve 30x40 mm
 17.6186 2 valve 40x40 mm

DENIS-BROWN

17.6181 Rahmen / frame / cadre / cuadro / telaio 180 x150 mm

17.6183 Rahmen / frame / cadre / cuadro / telaio 255 x180 mm

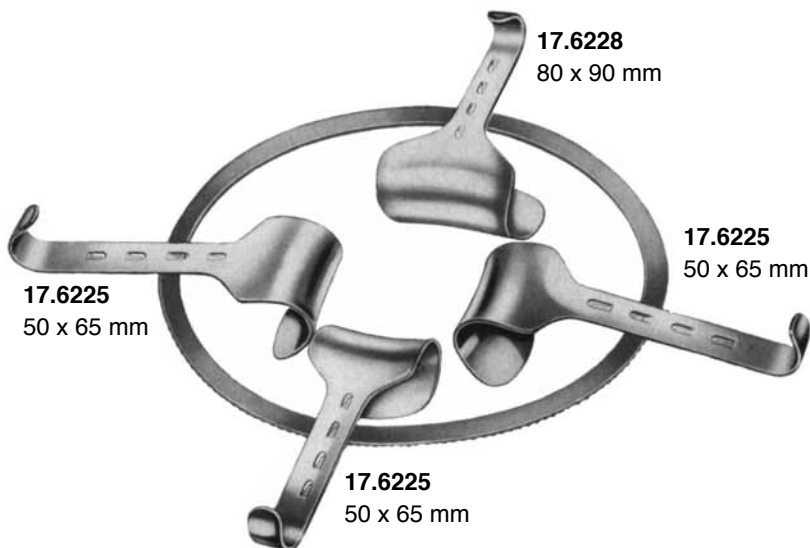

KIRSCHNER

- 17.6210** bestehend aus
 17.6211 ovaler Rahmen 300x240 mm
 17.6225 3 Valven 50x65 mm
 17.6228 1 Valve 80x90 mm
 17.6229 1 Valve 98x50 mm
 17.6230 1 Valve 105x35 mm
 consisting of:
 17.6211 oval Frame 300x240 mm
 17.6225 3 valves 50x65 mm
 17.6228 1 valve 80x90 mm
 17.6229 1 valve 98x50 mm
 17.6230 1 valve 105x35 mm
 comprenant:
 17.6211 cadre oval 300x240 mm
 17.6225 3 Valves 50x65 mm
 17.6228 1 Valve 80x90 mm
 17.6229 1 Valve 98x50 mm
 17.6230 1 Valve 105x35 mm
 compuesto de:
 17.6211 cuadro oval 300x240 mm
 17.6225 3 valvas 50x65 mm
 17.6228 1 valva 80x90 mm
 17.6229 1 valva 98x50 mm
 17.6230 1 valva 105x35 mm
 composto da:
 17.6211 telaio oval 300x240 mm
 17.6225 3 valve 50x65 mm
 17.6228 1 valva 80x90 mm
 17.6229 1 valva 98x50 mm
 17.6230 1 valva 105x35 mm

KIRSCHNER

- 17.6211** 300x240 mm
 Rahmen allein / Frame only / Cadre, seul / Cuadro, solo / Telaio, solo

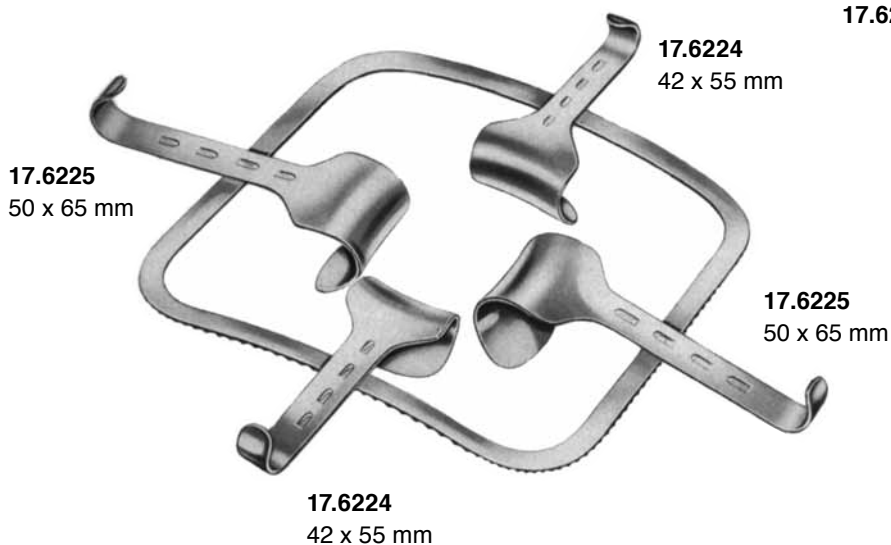

KIRSCHNER

- 17.6220** bestehend aus:
 17.6222 starrer Rahmen 250x250 mm
 17.6224 2 Valven 42 x 55 mm
 17.6225 2 Valven 50 x 65 mm
 consisting of:
 17.6222 rigid frame 250x250 mm
 17.6224 2 valves 42 x 55 mm
 17.6225 2 valves 50 x 65 mm
 comprenant:
 17.6222 cadre fixe 250 x 250 mm
 17.6224 2 valves 42 x 55 mm
 17.6225 2 valves 50 x 65 mm
 compuesto de:
 17.6222 cuadro fijo 250 x 250 mm
 17.6224 2 valvas 42 x 55 mm
 17.6225 2 valvas 50 x 65 mm
 composto da:
 17.6222 telaio fisso 250 x 250 mm
 17.6224 2 valve 42 x 55 mm
 17.6225 2 valce 50 x 65 mm

KIRSCHNER

- 17.6222** Rahmen allein / Frame only / Cadre, seul / Cuadro, solo / Telaio, solo

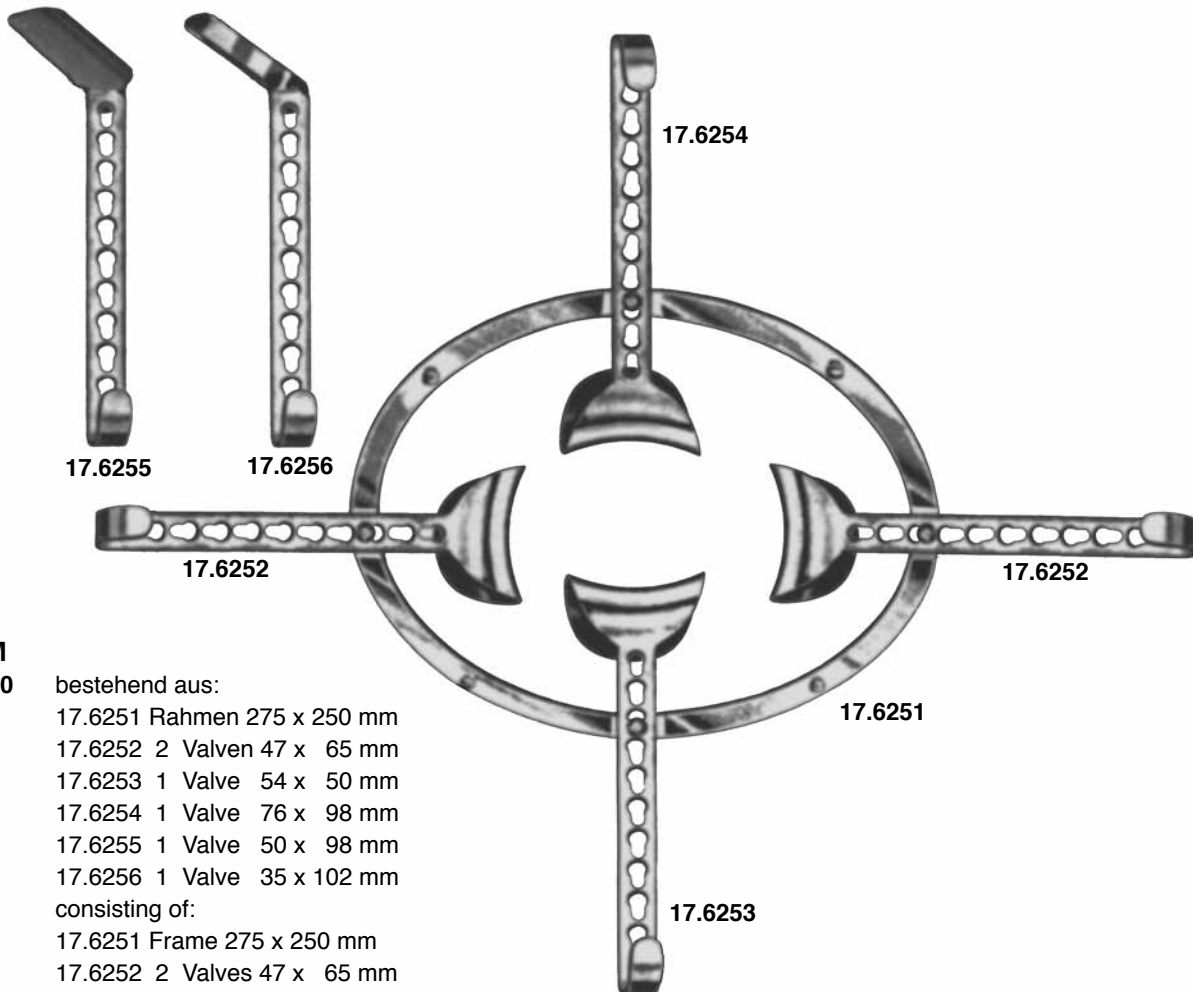

**SEMM
 17.6250**

bestehend aus:

- 17.6251 Rahmen 275 x 250 mm
- 17.6252 2 Valven 47 x 65 mm
- 17.6253 1 Valve 54 x 50 mm
- 17.6254 1 Valve 76 x 98 mm
- 17.6255 1 Valve 50 x 98 mm
- 17.6256 1 Valve 35 x 102 mm

consisting of:

- 17.6251 Frame 275 x 250 mm
- 17.6252 2 Valves 47 x 65 mm
- 17.6253 1 Valve 54 x 50 mm
- 17.6254 1 Valve 76 x 98 mm
- 17.6255 1 Valve 50 x 98 mm
- 17.6256 1 Valve 35 x 102 mm

comprenant:

- 17.6251 Cadre 275 x 250 mm
- 17.6252 2 Valves 47 x 65 mm
- 17.6253 1 Valve 54 x 50 mm
- 17.6254 1 Valve 76 x 98 mm
- 17.6255 1 Valve 50 x 98 mm
- 17.6256 1 Valve 35 x 102 mm

compuesto de:

- 17.6251 Cuadro 275 x 250 mm
- 17.6252 2 Valvas 47 x 65 mm
- 17.6253 1 Valva 54 x 50 mm
- 17.6254 1 Valva 76 x 98 mm
- 17.6255 1 Valva 50 x 98 mm
- 17.6256 1 Valva 35 x 102 mm

composto da:

- 17.6251 Telaio 275 x 250 mm
- 17.6252 2 Valve 47 x 65 mm
- 17.6253 1 Valva 54 x 50 mm
- 17.6254 1 Valva 76 x 98 mm
- 17.6255 1 Valva 50 x 98 mm
- 17.6256 1 Valva 35 x 102 mm

SEMM

17.6251 275 x 250 mm

Rahmen allein / Frame only / Cadre, seul /
 Cuadro, solo / Telaio, solo

17.6252 47 x 65 mm

17.6253 54 x 50 mm

17.6254 76 x 98 mm

17.6255 50 x 98 mm

17.6256 35 x 135 mm

Valve / Blades / Lames / Valvas / Valve

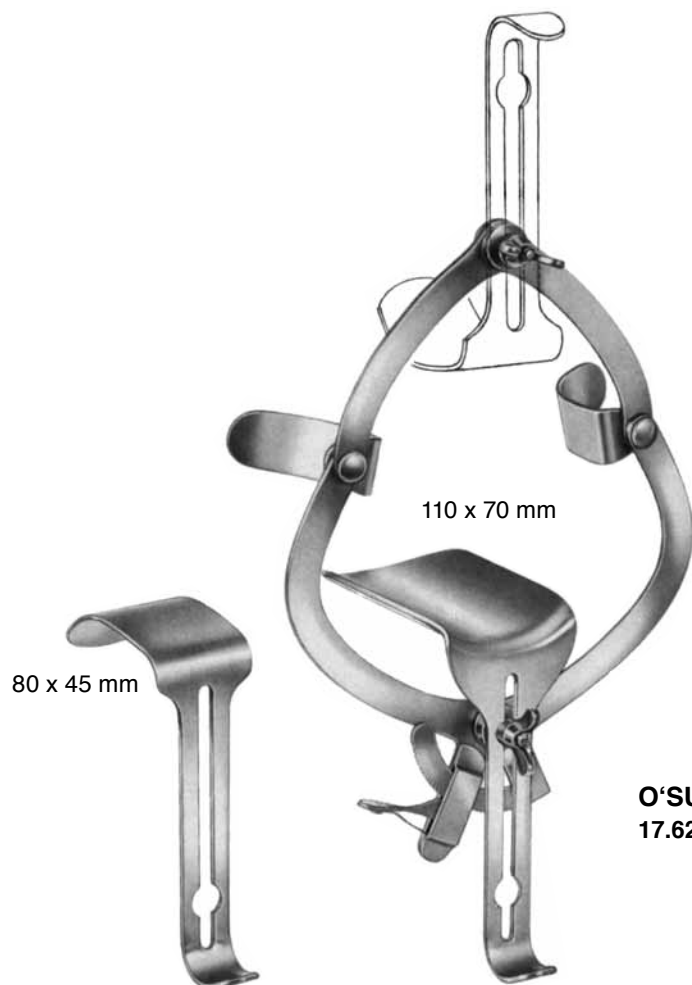

O'SULLIVAN-O'CONNOR

- 17.6260** bestehend aus:
17.6261 Rahmen mit 2 Seitenvalven 62 x 25 mm
17.6262 2 Valven 85 x 45 mm
17.6263 1 Valve 105 x 70 mm
consisting of:
17.6261 Frame with 2 lateral valves 62 x 25 mm
17.6262 2 Valves 85 x 45 mm
17.6263 1 Valve 105 x 70 mm
comprenant:
17.6261 Cadre avec 2 valves latérales 62 x 25 mm
17.6262 2 Valves 85 x 45 mm
17.6263 1 Valve 105 x 70 mm
compuesto de:
17.6261 Cuadro con 2 valvas laterales 62 x 25 mm
17.6262 2 Valves 85 x 45 mm
17.6263 1 Valva 105 x 70 mm
composta da:
17.6261 Telaio con 2 valve laterali 62 x 25 mm
17.6262 2 Valve 85 x 45 mm
17.6263 1 Valva 105 x 70 mm
- 17.6261** Rahmen allein / Frame only / Cadre, seul / Cuadro, solo / Telaio, solo
- 17.6262** 45 x 85 mm
- 17.6263** 70 x 105 mm
Valve / Blades / Lames / Valvas / Valve

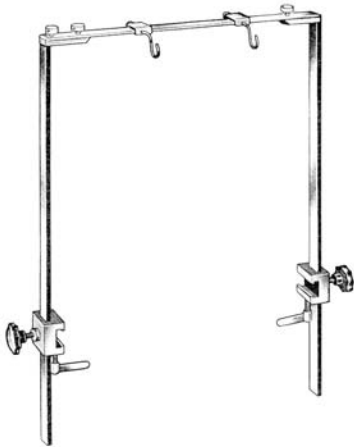

ROCHARD
17.6277
 Rahmen, doppelt
 Frame, double
 Cadre, double
 Quadro doble
 Telaio doppio

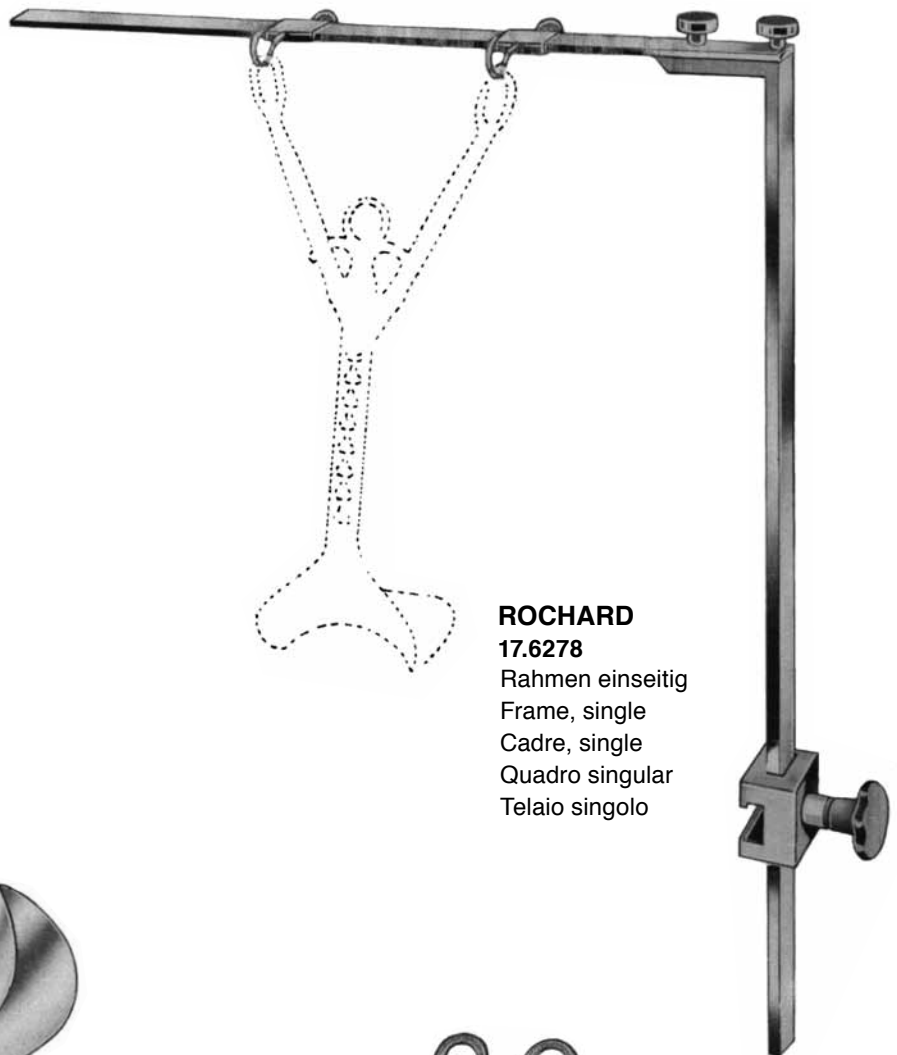

ROCHARD
17.6278
 Rahmen einseitig
 Frame, single
 Cadre, single
 Quadro singular
 Telaio singolo



ROCHARD
17.6270 95 mm
17.6271 105 mm
17.6272 120 mm
17.6273 135 mm
17.6274 155 mm



ROCHARD
17.6279
 Fixiervorrichtung
 Fixation device
 Compas articulé
 Dispositivo de fijación
 Dispositivo di fissaggio



DOYEN

17.6350 55 x 95 mm
17.6353 55 x 105 mm
17.6354 55 x 115 mm
17.6355 55 x 125 mm

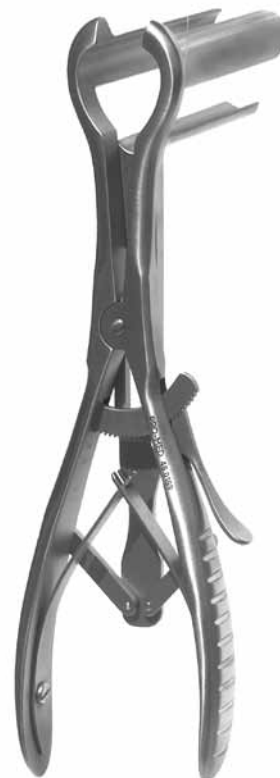

ABDOMINAL

46.0169 20,5 cm
Spekulum 70 mm / 90°
Abdominal Specula 70 mm / 90°
Spéculum abdominal 70 mm / 90°
espéculeo abdominale 70 mm / 90°
Specola abdominale 70 mm / 90°



17.6309 8 mm \varnothing

20 Ersatzknöpfe

20 Spare buttons

20 Boutons de rechange

20 Botones de repuesto

20 Bottone de ricambio

FOERSTER

17.6300 \varnothing 255 mm

Kunststoff, schwarz, röntgenfähig, komplett mit 4 Valven Nr. 17.6303

plastic, black, transparent to X-Ray, complete with 4 valves 17.6303

plastique, noir, transparent aux rayons X, complet avec 4 valves 17.6303

plástico, negro, transparente a los rayos-X, completo con 4 valvas 17.6303

plastica, nero, radiotrasparente, completo con 4 valve 17.6303

17.6301

Rahmen / frame / Cadre / Cuadro / Telaio \varnothing 255 mm



17.6303 50 x 65 mm



17.6304 65 x 75 mm

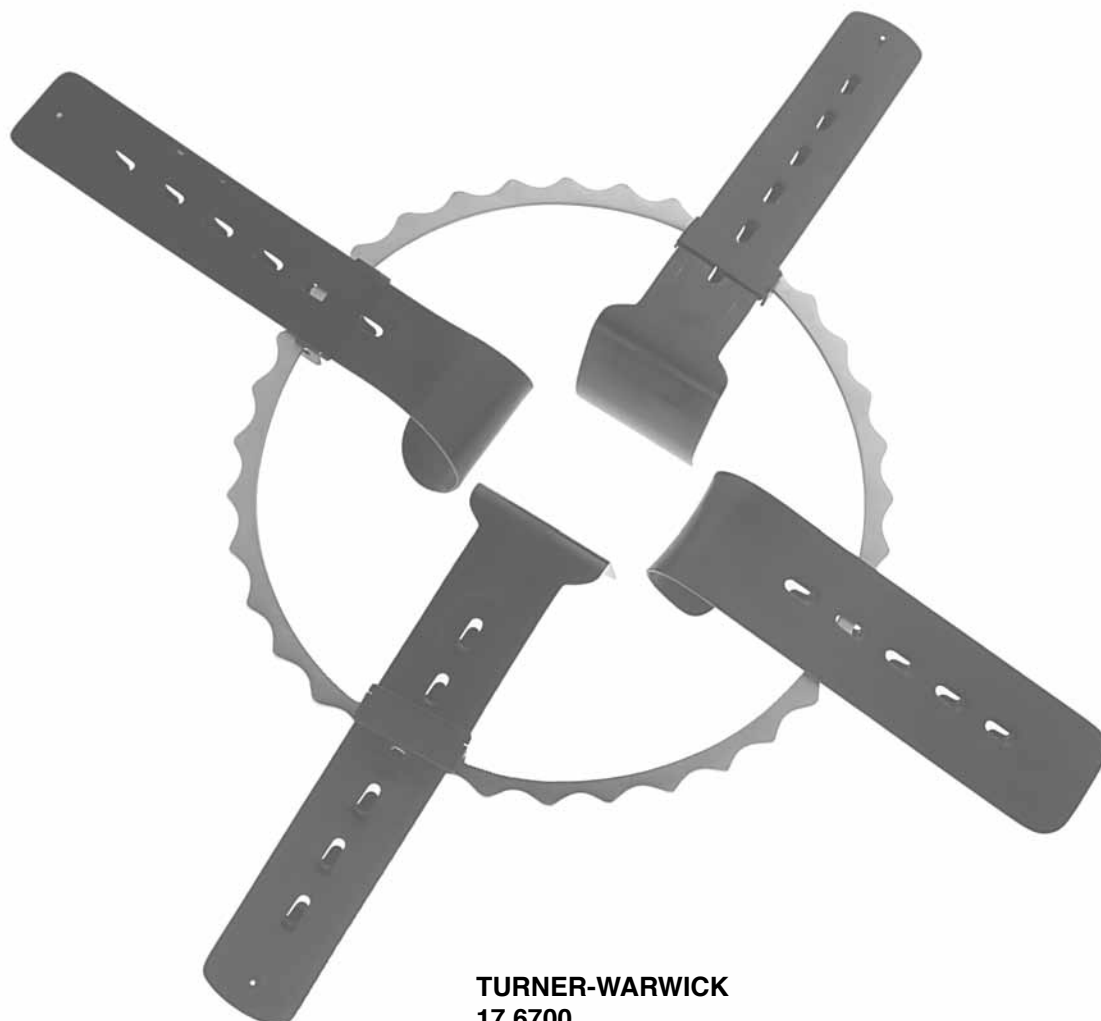

TURNER-WARWICK

17.6700

bestehend aus

consisting of:

comprendant:

compuesto de:

composta da:

17.6701 1

17.6702 1

17.6703 1

17.6710 2

17.6711 2

17.6712 2

17.6713 2

17.6714 2

17.6715 2

17.6716 2

17.6717 2

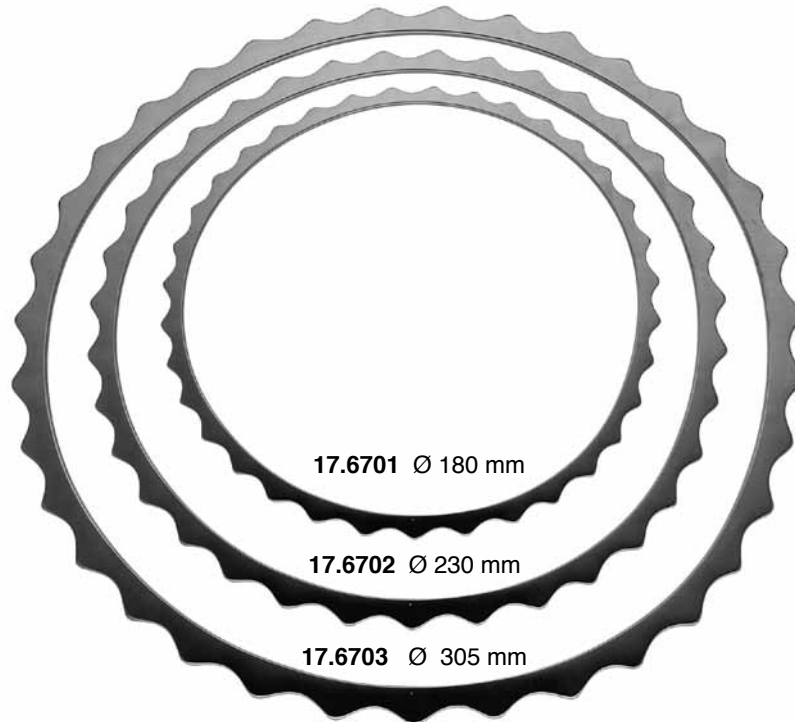

17.6701 Ø 180 mm

17.6702 Ø 230 mm

17.6703 Ø 305 mm

TURNER-WARWICK

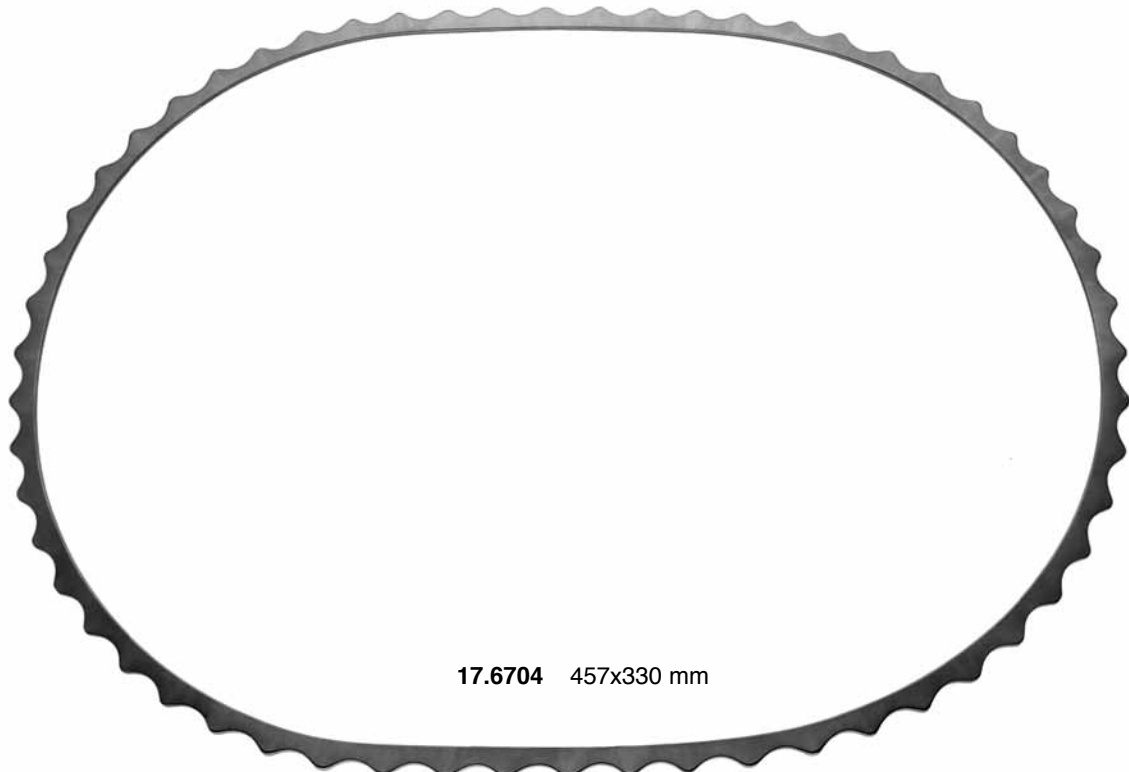

17.6704 457x330 mm

TURNER-WARWICK



TURNER-WARWICK
17.6710 76 x 19 mm

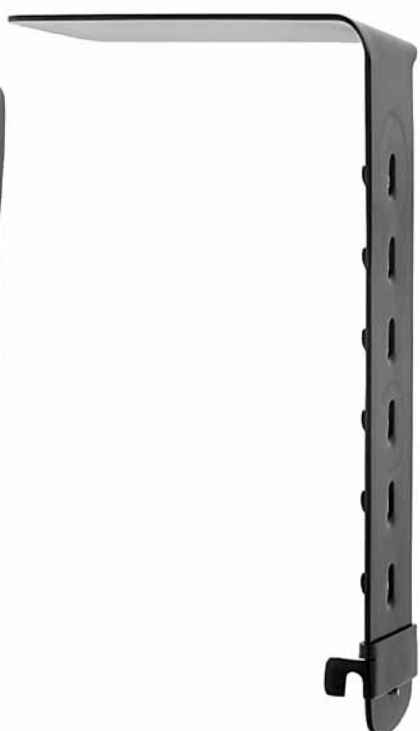

TURNER-WARWICK
17.6711 102 x 38 mm



TURNER-WARWICK
17.6712 89 x 57 mm



TURNER-WARWICK
17.6713 114 x 57 mm



TURNER-WARWICK
17.6714 51 x 38 mm

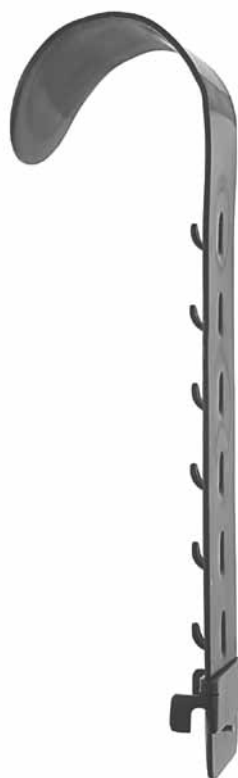

TURNER-WARWICK
17.6715 76 x 60 mm

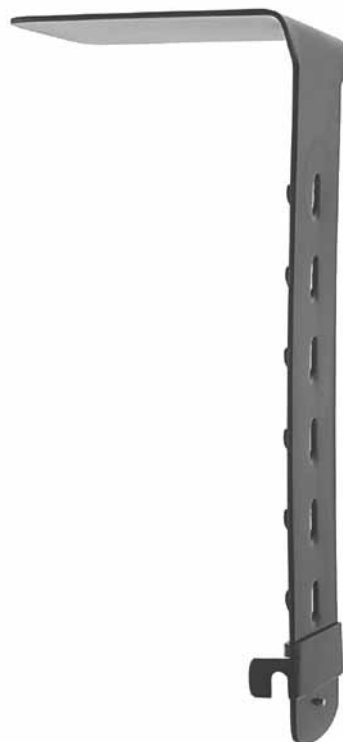

TURNER-WARWICK
17.6716 89 x 60 mm
17.6717 114 x 60 mm



TURNER-WARWICK
17.6718 13 mm

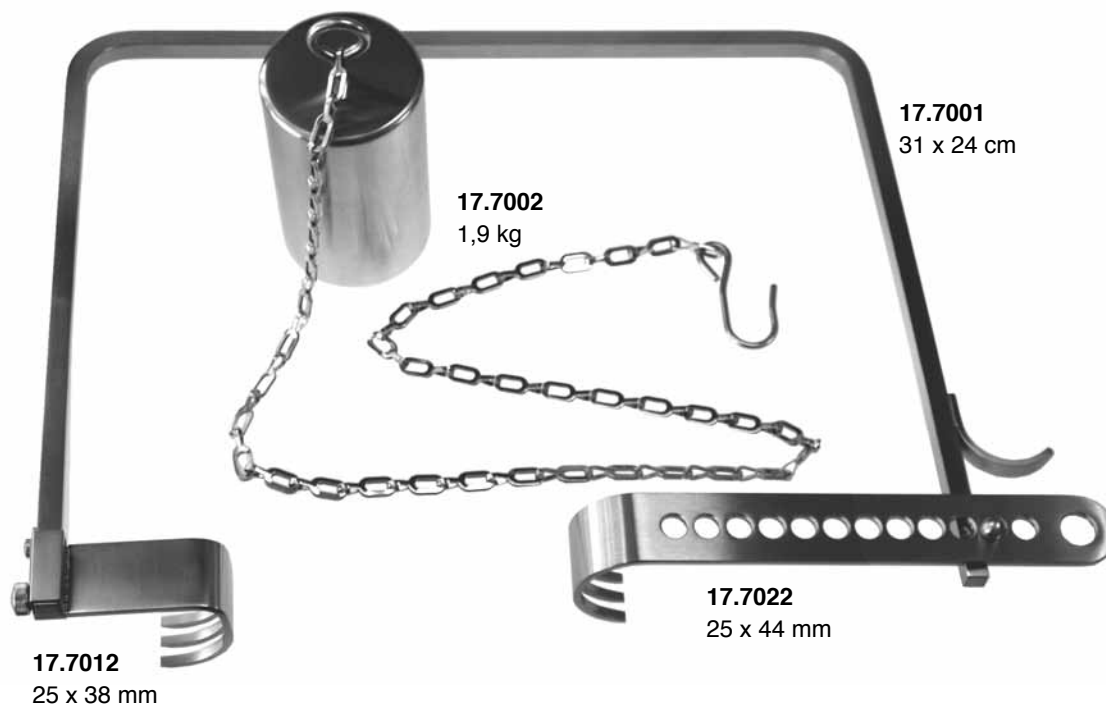

CHARNLEY compl.
17.7000

bestehend aus:

consisting of:

comprendand:

compuesto de:

composta da:

17.7001 Rahmen / Frame / Cadre / Cuadro / Telaio 31 x 24 cm

17.7002 Gewicht mit Kette / Weight with chain / poids avec chaîne /
peso con cadena / peso con catena

17.7012 Valve / Valve / Valva / Valve 25 x 38 mm



17.7022 Valve / Valve / Valva / Valve 25 x 44 mm



NAHT
SUTURE
SUTURE
SUTURA
SUTURA





CASTROVIEJO

		
18.0800	14 cm	18.0810
18.0802	18 cm	18.0812
18.0804	22 cm	18.0814
18.1800	14 cm	18.1810
18.1802	18 cm	18.1812
18.1804	22 cm	18.1814

		
18.0801	14 cm	18.0811
18.0803	18 cm	18.0813
18.0805	22 cm	18.0815
18.1801	14 cm	18.1811
18.1803	18 cm	18.1813
18.1805	22 cm	18.1815



CASTROVIEJO

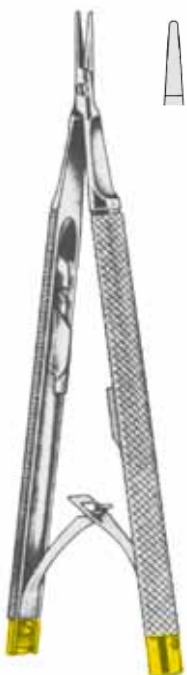

CASTROVIEJO
18.0840 13 cm

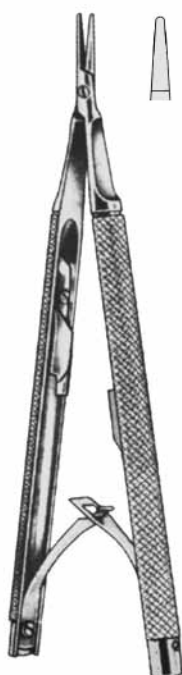

CASTROVIEJO
18.1840 13 cm



BOYNTON
18.1850 12 cm



mit Sperre
with lock
avec arrêt
con cierre
con caramagliera

21 cm

28.3154
gerade
straight
droit
recto
retto

28.3155
gebogen
curved
courbe
curvo
curvo



mit Sperre
with lock
avec arrêt
con cierre
con caramagliera

23 cm

28.3156
gerade
straight
droit
recto
retto

28.3157
gebogen
curved
courbe
curvo
curvo



15 cm

28.3242
gerade
straight
droit
recto
retto

28.3243
gebogen
curved
courbe
curvo
curvo



18 cm

28.3252
gerade
straight
droit
recto
retto

28.3253
gebogen
curved
courbe
curvo
curvo



21 cm

28.3254

gerade
straight
droit
recto
retto

28.3255

gebogen
curved
courbe
curvo
curvo



23 cm

28.3256

gerade
straight
droit
recto
retto

28.3257

gebogen
curved
courbe
curvo
curvo



Diamantbeschichtete Spitzen
Diamond coated tips
Avec bouts de diamant
Puntas con cascós de diamante
Morsi con rivestimento di diamante



Maul 2 mm breit gerieft
Jaws 2 mm wide serrated
mors 2 mm, dentelées
boca 2 mm, dentadas
morso 2 mm, dentate

28.3662

18 cm / 10 mm

28.3664

21 cm / 10 mm

GREGORY



28.3662D

18 cm / 10 mm

28.3664D

21 cm / 10 mm







GREGORY







TITANIUM















Diamantbeschichtete Spitzen
 Diamond coated tips
 Avec bouts de diamant
 Puntas con cascos de diamante
 Morsi con rivestimento di diamante

mit Sperre
 with lock
 avec arrêt
 con cierre
 con arresto

			
0,4mm			
15 cm	28.3630	28.3630SD	28.3630S
18 cm	28.3632	28.3632SD	28.3632S
21 cm	28.3634	28.3634SD	28.3634S
23 cm	28.3636	28.3636SD	28.3636S

			
0,4mm			
15 cm	28.3631	28.3631SD	28.3631S
18 cm	28.3633	28.3633SD	28.3633S
21 cm	28.3635	28.3635SD	28.3635S
23 cm	28.3637	28.3637SD	28.3637S

			
0,8mm			
15 cm	28.3640	28.3640SD	28.3640S
18 cm	28.3642	28.3642SD	28.3642S
21 cm	28.3644	28.3644SD	28.3644S
23 cm	28.3646	28.3646SD	28.3646S

			
0,8mm			
15 cm	28.3641	28.3641SD	28.3641S
18 cm	28.3643	28.3643SD	28.3643S
21 cm	28.3645	28.3645SD	28.3645S
23 cm	28.3647	28.3647SD	28.3647S

TITANIUM

TITANIUM

TITANIUM



Diamantbeschichtete Spitzen
 Diamond coated tips
 Avec bouts de diamant
 Puntas con cascós de diamante
 Morsi con rivestimento di diamante

ohne Sperre
 without lock
 sans arrêt
 sin cierre
 senza caramagliera



1 mm
 21 cm



28.3700



28.3700SD



28.3700S

1 mm
 21 cm



28.3701



28.3701SD



28.3701S

1 mm
 23 cm



28.3702



28.3702SD



28.3702S

1 mm
 23 cm



28.3703



28.3703SD



28.3703S

TITANIUM

TITANIUM

MIKRO-NADELHALTER MIT PROFILGRIFF
MICRO-NEEDLEHOLDERS WITH PROFILE HANDLE
MICRO-PORTE-AIGUILLES AVEC MANCHE PROFIL
MICRO-PORTA-AGUJAS CON MANGO "PERFIL"
MICRO-PORTHAGI CON MANICO "PROFILO"

PRO-MED



28.3504 20,0 cm
28.3506 22,0 cm



28.3501 16,0 cm
28.3505 20,0 cm
28.3507 22,0 cm
28.3509 24,0 cm



<p>NEIVERT 18.0050 12 cm</p>	<p>BABY-CRILE-WOOD 18.0069 15 cm</p>	<p>CRILE-WOOD</p>	<p>18.0070 15 cm</p>	<p>18.0071 15 cm</p>	
			<p>18.0070L 15 cm für Linkshänder for left-handers pour gauchers para zurdos per mono sinistra</p>		
			<p>18.0072 18 cm</p>	<p>18.0074 20 cm</p>	<p>18.0076 23 cm</p>
			<p>18.0072L 18 cm</p>	<p>18.0074L 20 cm</p>	<p>18.0076L 23 cm</p>
			<p>für Linkshänder / for left-handers / pour gauchers para zurdos / per mono sinistra</p>		

TITANIUM

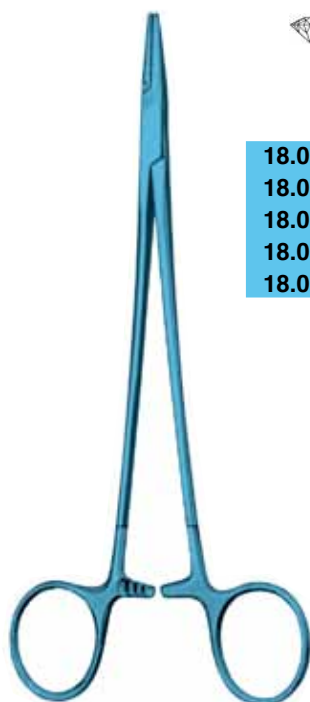

MICRO-VASCULAR







- 18.0016TD** 12,5 cm
- 18.0070TD** 14,5 cm
- 18.0100TD** 17,5 cm
- 18.0102TD** 19,5 cm
- 18.0104TD** 22,5 cm

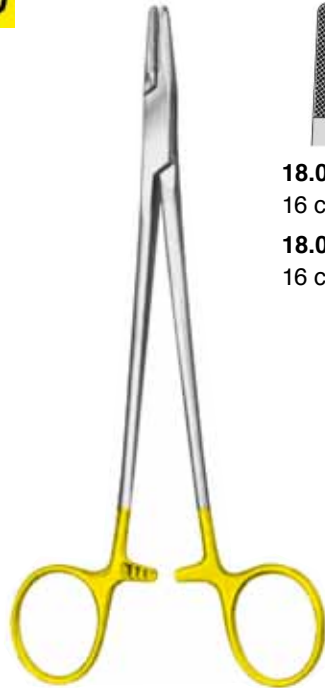





Diamantbeschichtete Spitzen
 Diamond coated tips
 Avec bouts de diamant
 Puntas con cascós de diamante
 Morsi con rivestimento di diamante



MAYO-HEGAR

				
18.0080 16 cm	18.0082 18 cm	18.0084 20 cm	18.0086 24 cm	18.0088 26 cm
18.0080L 16 cm	18.0082L 18 cm	18.0084L 20 cm	18.0086L 24 cm	18.0088L 26 cm

für Linkshänder / for left-handers / pour gauchers / para zurdos / per mono sinistra

			
18.0090 30 cm	18.0092 35 cm	18.0094 37 cm	18.0096 40 cm

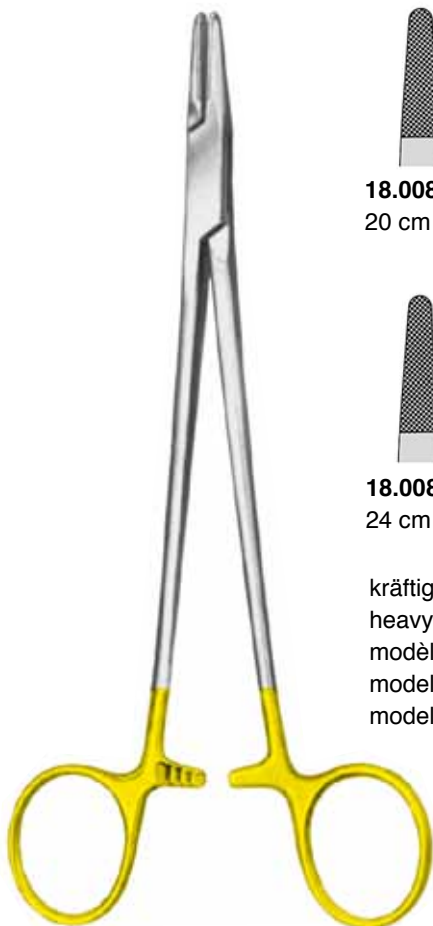

MAYO-HEGAR







18.0084HP
 20 cm

18.0086HP
 24 cm

kräftige Modelle
 heavy patterns
 modèles forts
 modelos robustos
 modelli robusti



DEBAKEY

		
18.0100 18 cm	18.0102 20 cm	18.0104 23 cm
		
18.0106 26 cm	18.0108 30 cm	18.0110 37 cm



LANGENBECK

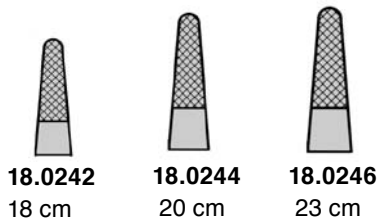

18.0242
18 cm

18.0244
20 cm

18.0246
23 cm

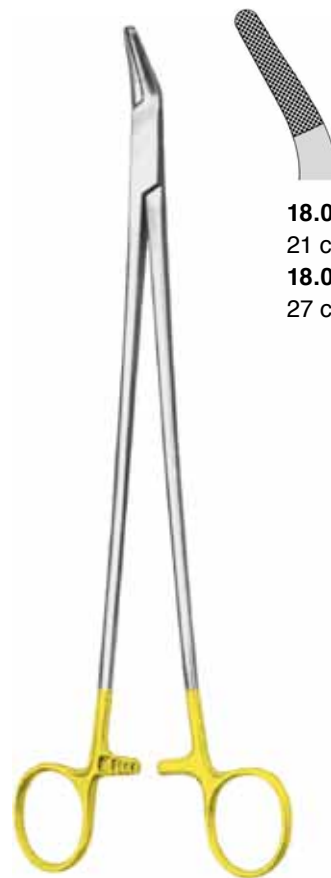

FINOCHIETTO

18.0150
21 cm
18.0152
27 cm

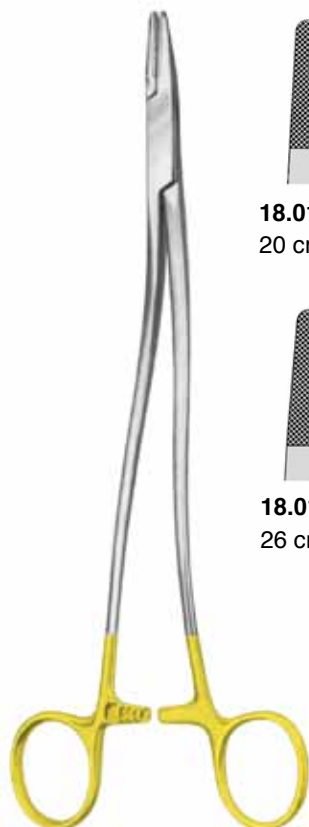

BOZEMANN

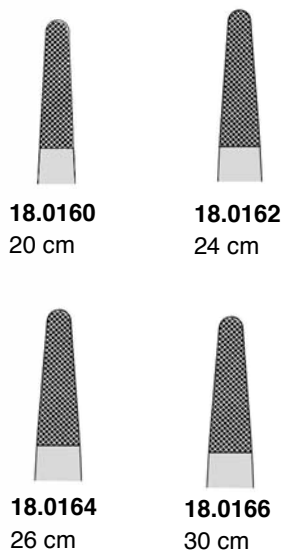

18.0160
20 cm

18.0162
24 cm

18.0164
26 cm

18.0166
30 cm



MASSON
18.0170 27 cm



WANGENSTEEN
18.0180 28 cm

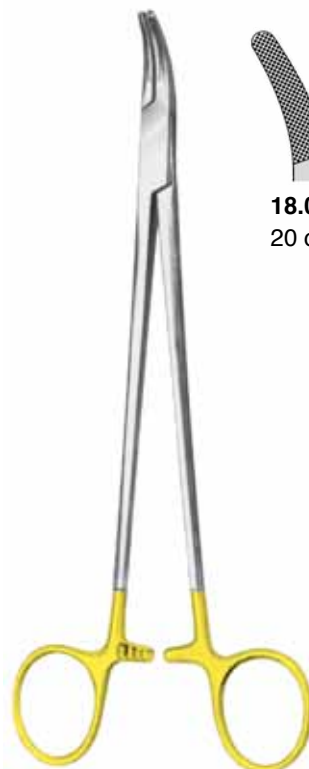

HEANEY



18.0190
20 cm



18.0192
24 cm



18.0194
26 cm



STRATTE

18.0202
21 cm

18.0204
23 cm



NAUNTON-MORGAN

18.0220
26 cm

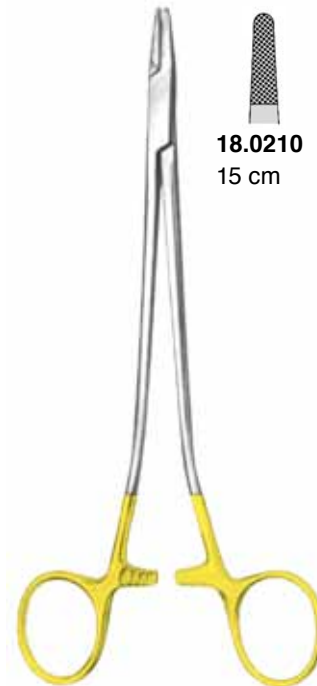

SAROT

18.0210
15 cm

18.0212
18 cm

18.0214
27 cm



MATHIEU

18.0250
14 cm

18.0252
17 cm

18.0254
20 cm

18.0256
24 cm



MATHIEU

18.0260
14 cm

18.0262
17 cm

18.0264
20 cm

18.0266
23 cm

mit Innensperre
 with inside ratchet
 avec crémaillère interne
 con cremallera interior
 con cremagliera interna



MATHIEU-KOCHER

18.0270
14 cm

18.0272
17 cm

18.0274
20 cm



LICHTENBERG

18.0280
20 cm

Maul glatt mit Spezialkehle
Smooth jaws, with special groove
Mâchoires lisses, avec cannelure spécial
Bocas lisas, con acanaladura especial
morso liscio con scannellatura speciale



NEIVERT
18.1050 12 cm



CRILE
18.1060 15 cm



CRILE-MURRAY
18.1065 15 cm



CRILE-WOOD
18.1070 15 cm



CRILE-WOOD

18.1072
18 cm

18.1074
20 cm

18.1076
23 cm

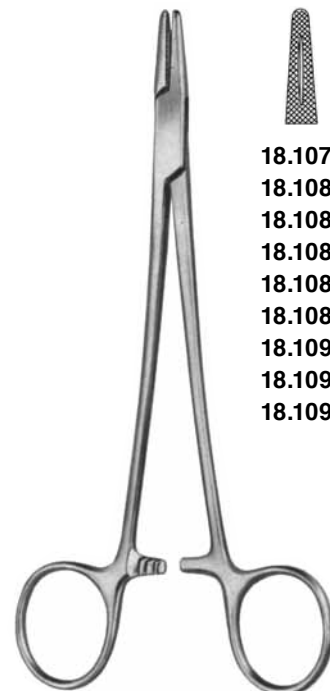

MAYO-HEGAR

- 18.1078** 14 cm
- 18.1080** 16 cm
- 18.1082** 18 cm
- 18.1084** 20 cm
- 18.1086** 24 cm
- 18.1088** 26 cm
- 18.1090** 30 cm
- 18.1092** 35 cm
- 18.1094** 40 cm



METZENBAUM
18.1100 18 cm



ADSON
18.1110 18 cm



FINOCHIETTO
18.1152 21 cm
18.1154 27 cm



JOHNSON
18.1160 27 cm



BOZEMANN
18.1161 20 cm
18.1162 24 cm
18.1164 26 cm



MASSON
18.1170 27 cm

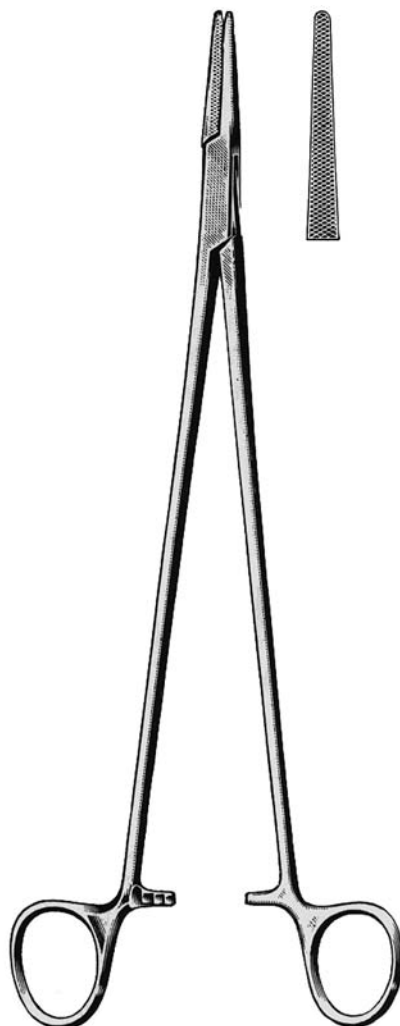

WANGENSTEEN
18.1180 27 cm



HEANEY (HEGAR)
18.1190 20 cm

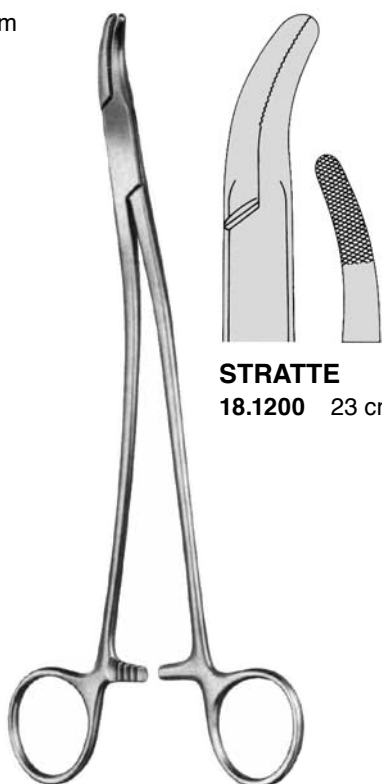

STRATTE
18.1200 23 cm



SAROT
18.1212 18 cm
18.1214 26 cm

SONDEN, SAUGROHRE, TROKARE
PROBES, ASPIRATION, TROCARS
STYLETS, ASPIRATION, TROCARTS
ESTILETES, ASPIRACION ,TROCARES
SPECILLI, ASPIRAZIONE, TREQUARTI

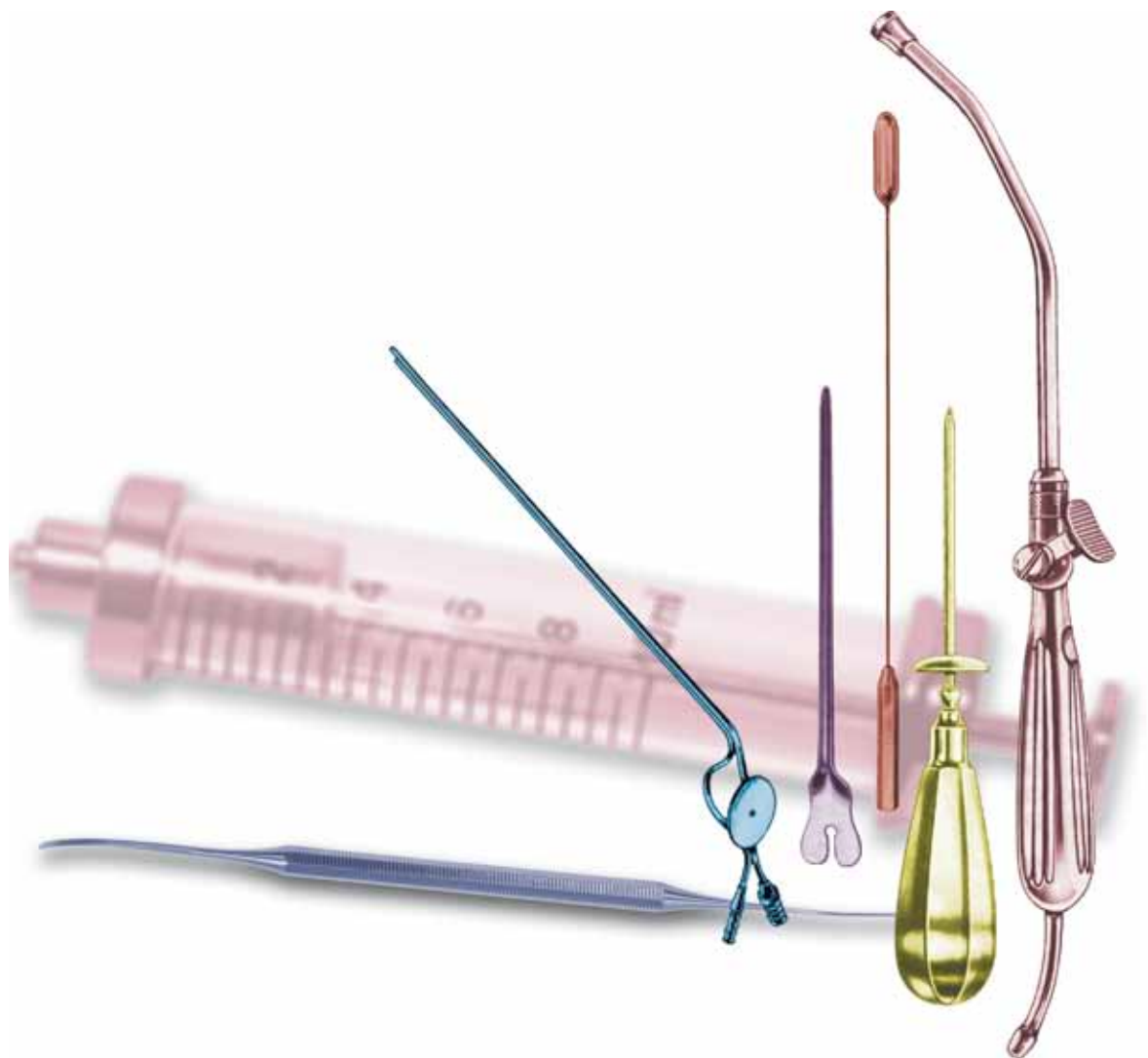



19.0101
13,0 cm /Ø 1,0 mm
19.0102
14,5 cm /Ø 1,0 mm
19.0103
16,0 cm /Ø 1,0 mm
19.0104
18,0 cm /Ø 1,0 mm
19.0105
20,0 cm /Ø 1,0 mm
19.0106
25,0 cm /Ø 1,0 mm



19.0109
10,5 cm /Ø 1,5 mm
19.0110
11,5 cm /Ø 1,5 mm
19.0111
13,0 cm /Ø 1,5 mm
19.0112
14,5 cm /Ø 1,5 mm
19.0113
16,0 cm /Ø 1,5 mm
19.0114
18,0 cm /Ø 1,5 mm
19.0115
20,0 cm /Ø 1,5 mm
19.0116
25,0 cm /Ø 1,5 mm
19.0117
30,0 cm /Ø 1,5 mm



19.0119
10,5 cm /Ø 2,0 mm
19.0120
11,5 cm /Ø 2,0 mm
19.0121
13,0 cm /Ø 2,0 mm
19.0122
14,5 cm /Ø 2,0 mm
19.0123
16,0 cm /Ø 2,0 mm
19.0124
18,0 cm /Ø 2,0 mm
19.0125
20,0 cm /Ø 2,0 mm
19.0126
25,0 cm /Ø 2,0 mm
19.0127
30,0 cm /Ø 2,0 mm



Ø 4,0 mm

19.0128
40 cm



19.0200
11,5 cm /Ø 2,0 mm
19.0201
13,0 cm /Ø 2,0 mm
19.0202
14,5 cm /Ø 2,0 mm
19.0203
16,0 cm /Ø 2,0 mm
19.0204
18,0 cm /Ø 2,0 mm
19.0205
20,0 cm /Ø 2,0 mm
19.0206
25,0 cm /Ø 2,0 mm
19.0207
30,0 cm /Ø 2,0 mm



Silber
Silver
Argent
Plata
Argento

19.0210
11,5 cm /Ø 2,0 mm
19.0211
13,0 cm /Ø 2,0 mm
19.0212
14,5 cm /Ø 2,0 mm
19.0213
16,0 cm /Ø 2,0 mm
19.0214
18,0 cm /Ø 2,0 mm
19.0215
20,0 cm /Ø 2,0 mm
19.0216
25,0 cm /Ø 2,0 mm

mit Ohr / with eye / avec oeillet / con ojo / con occhiello



19.0302
 14,5 cm
19.0303
 16 cm

MYRTLE



19.0320
 11,5 cm
19.0321
 13 cm
19.0322
 14,5 cm
19.0323
 16 cm
19.0324
 18 cm
19.0325
 20 cm

DOYEN



19.0332
 14.5 cm



19.0351
 11,5 cm
19.0352
 13 cm
19.0353
 14,5 cm
19.0354
 16 cm
19.0355
 18 cm
19.0356
 20 cm



NELATON
19.0363 16 cm

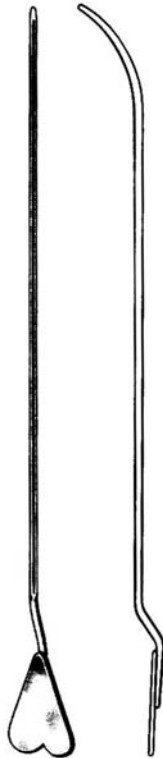

LOCKHART-MUMMERY
 16,5 cm



19.0371
 # 1



19.0372
 # 2



19.0373
 # 3



19.0374
 # 4



ANDREW-PYNCHON

19.0700 24 cm

Ø 6 mm



COUPLAND

33.1160 26 cm

mit 2 Ansätzen
with 2 tips
avec 2 embouts
con 2 puntas
con 2 punte
1,5 / 2,0 mm Ø

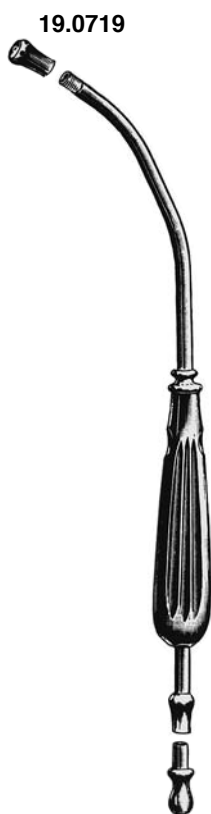

19.0719

YANKAUER

19.0710 27 cm

19.0711 36 cm

19.0712 40 cm

19.0713 46 cm

Ø 10 mm

komplett

complete

complet

completo

19.0718



mit Absperrventil u. abschraubbarem Rohr
with stopcock and removeable tube
avec robinet et canule demontable
con llave y tubo desmontable
con interruttore e tubo svitabile

YANKAUER

19.0715 33 cm

Ø 10 mm



POOLE
19.0726
20 cm, Ø 5,5 mm



POOLE
19.0727
20 cm, Ø 5,5 mm



POOLE
19.0720
23 cm / 30 Fr.



POOLE
19.0721 20 cm, Ø 8 mm
19.0722 30 cm, Ø 10 mm
19.0723 36 cm, Ø 10 mm
19.0724 46 cm, Ø 10 mm

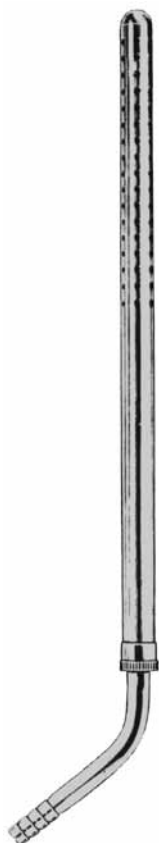

WIJNEN
19.0738
33 cm Ø 12 mm



DEBAKEY
19.0746
31 cm Ø 9 mm



DEBAKEY
19.0747
16 cm Ø 5 mm
19.0748
27 cm Ø 5 mm

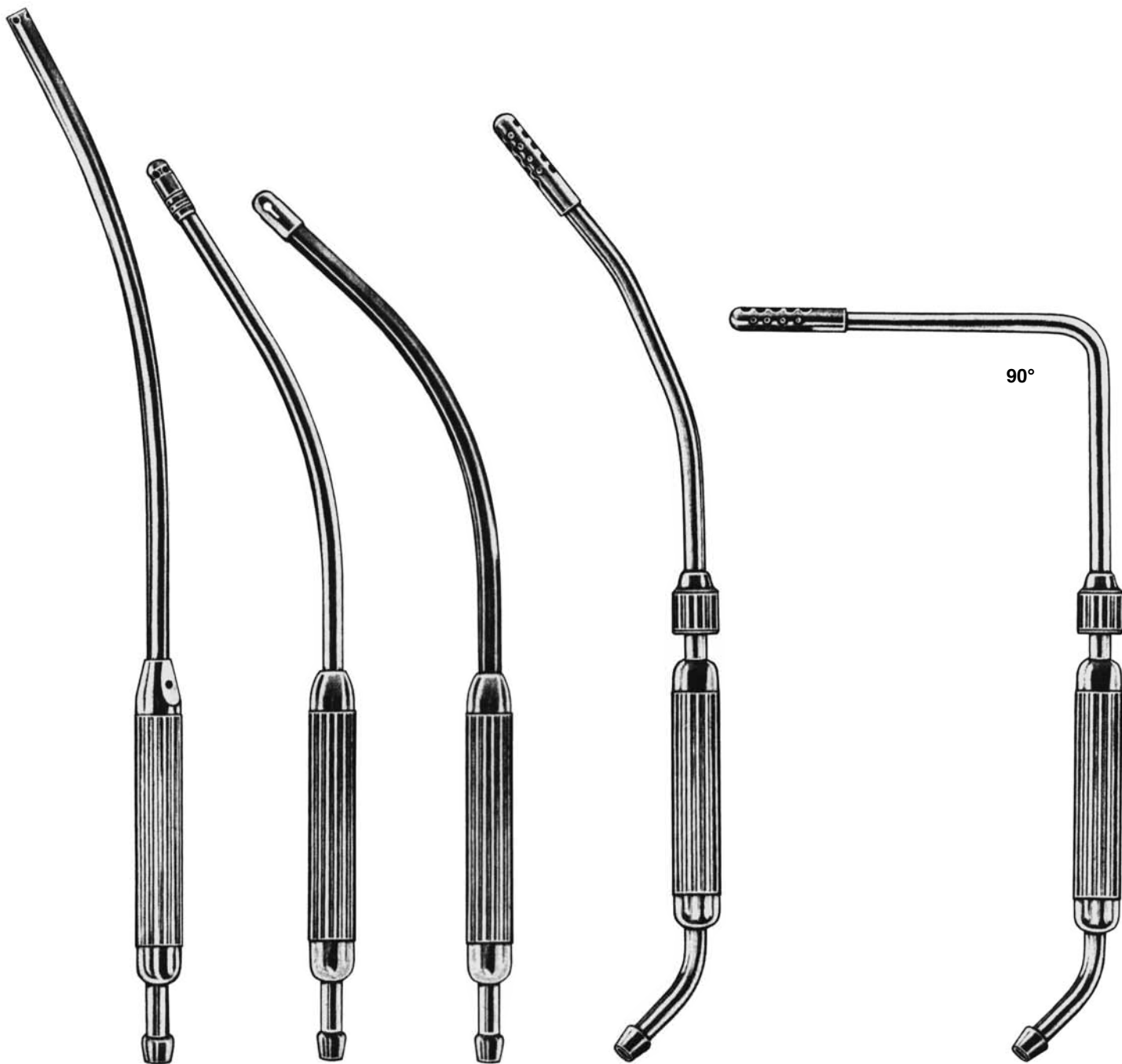

COOLEY
19.0750
36 cm
Ø 8 mm #1

COOLEY
19.0751
31 cm
Ø 7 mm #2

COOLEY
19.0752
31 cm
Ø 10 mm #3

COOLEY
19.0753
35 cm
Ø 8 mm #4

COOLEY
19.0754
25 cm
Ø 9 mm #5

Probes, Suction Tubes / Sondes, Tubes d'aspiration / Sondas, Tubos de aspiración / Sonde, Tubi d'aspirazione

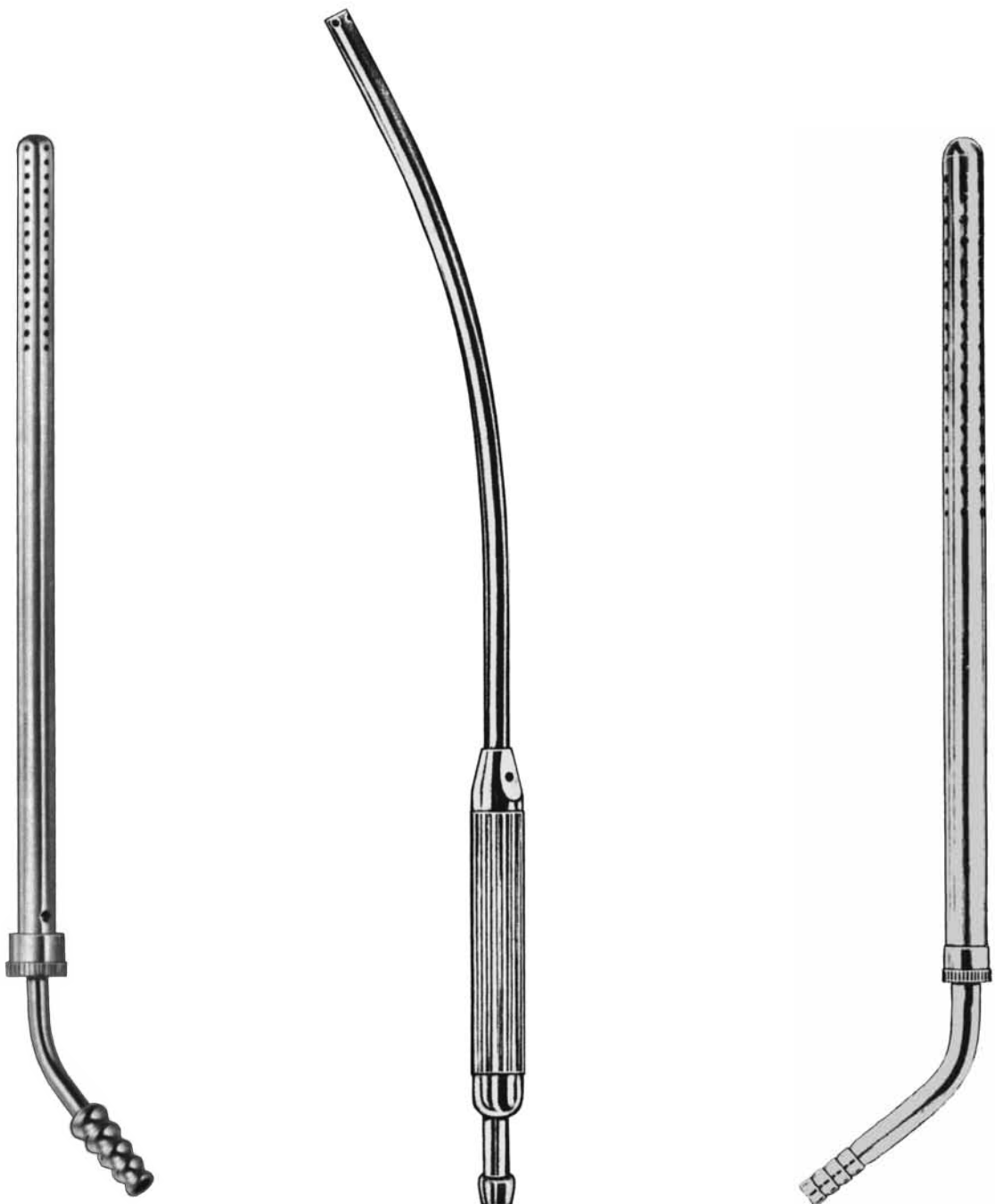

POOLE
19.0722 30 cm, Ø 10 mm
19.0723 35 cm, Ø 10 mm
19.0724 46 cm, Ø 10 mm

COOLEY
19.0750
36 cm, Ø 8 mm

WIJNEN
19.0738
33 cm, Ø 12 mm



19.1010
mit 4 Trokaransätzen
with 4 trocar tips
avec 4 embouts de trocars
con 4 puntas de trócar
con 4 punte di trequarti
1,7, 3,0, 4,5 + 6,0 mm Ø

UNIVERSAL
14 cm



Ø
19.1020 3,0 mm
19.1021 3,5 mm
19.1022 4,0 mm
19.1023 4,5 mm
19.1024 5,0 mm
19.1025 5,5 mm
19.1026 6,0 mm

UNIVERSAL



Ø
19.1030 3,0 mm
19.1031 3,5 mm
19.1032 4,0 mm
19.1033 4,5 mm
19.1034 5,0 mm
19.1035 5,5 mm
19.1036 6,0 mm

mit Absperrventil
with stopcock
avec robinet
con interruptor
con interruttore

UNIVERSAL



LICHTWITZ
19.1050
19 cm Ø1,75 mm



Ø
19.1199 9 Fr. / 3,0 mm
19.1200 10 Fr. / 3,5 mm
19.1201 12 Fr. / 4,0 mm
19.1202 14 Fr. / 4,5 mm
19.1204 16 Fr. / 5,5 mm
19.1205 18 Fr. / 6,0 mm
19.1206 20 Fr. / 6,5 mm

OCHSNIER
15 cm



Ø
19.1210 25 Fr./ 8 mm
19.1211 30 Fr./10 mm
19.1212 33 Fr./11 mm
19.1213 35 Fr./12 mm

NELSON
21 cm

STERILISATION
STERILIZATION
STERILISATION
ESTERILIZACION
STERILIZZAZIONE

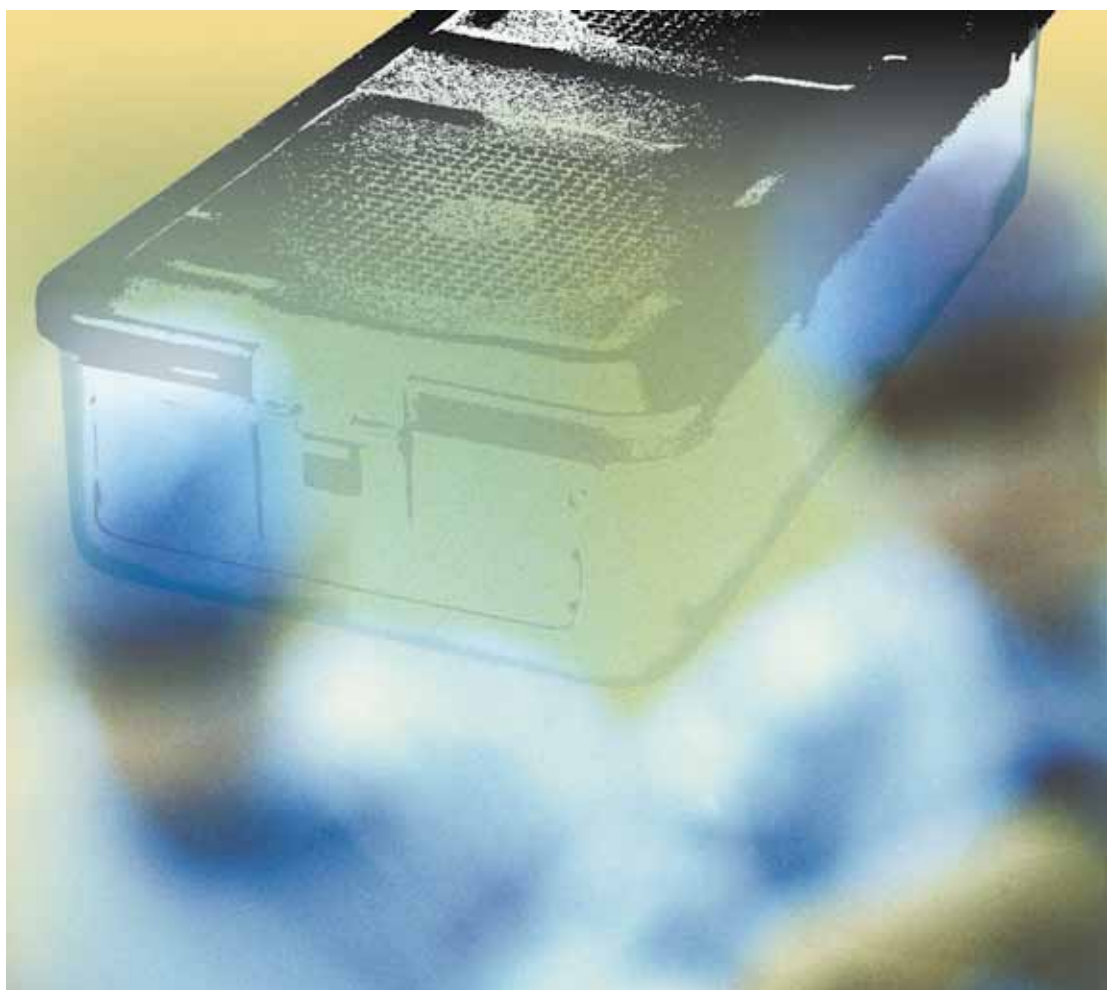



DAVIS
16.1000 16 cm
16.1002 20 cm
16.1004 25 cm



CHEATTLE
16.1010 27 cm



ROGGE
16.1020 23 cm



STERILIZING
16.1030 20 cm
16.1032 30 cm

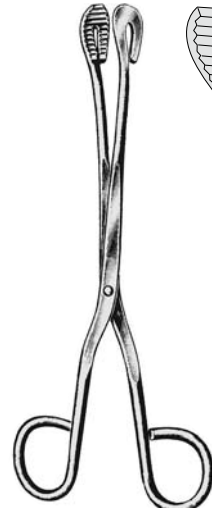

STERILIZING
16.1040 20 cm
16.1042 28 cm

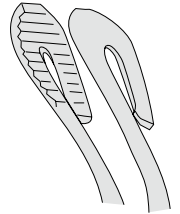

16.1041 20 cm
16.1043 28 cm

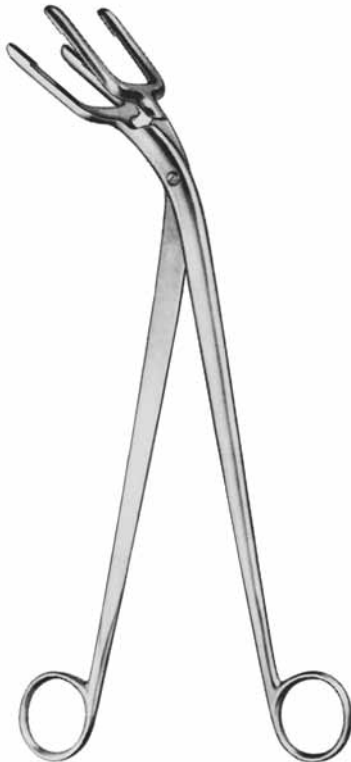

HARRISON
16.1050 25 cm
16.1052 30 cm



MARTIN
16.1060 58 cm



SAUERBRUCH
16.1070 55 cm



BUNT
 16.1100
 12 cm

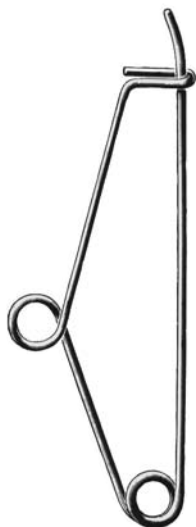

MAYO
 16.1110
 14 cm



MAYO
 16.1115
 14 cm



STRINGER

- 16.1150 10 x 7 cm
- 16.1152 15 x 7 cm
- 16.1153 20 x 7 cm
- 16.1154 25 x 7 cm
- 16.1155 30 x 7 cm
- 16.1156 35 x 7 cm
- 16.1157 40 x 7 cm
- 16.1158 45 x 9 cm
- 16.1159 50 x 9 cm



16.1500

Infusionsflaschen-Öffnungszange
 Infusion-bottle Opening Forceps
 Pince pour ouvrir les bouteilles d'infusion
 Pinza para abrir botellas de infusión
 Pinza apri flebo

1/2 Container, ALU

Deckel gelocht und farbig
 Lid perforated and colored
 Couvercle perforé et coloré
 Tapas perforadas y coloreados
 Coperchio perforato e colorato



L x B x H mm

285x280x100	80.6001	80.6002	80.6003	80.6004	80.6005	80.6006
285x280x135	80.6011	80.6012	80.6013	80.6014	80.6015	80.6016
285x280x150	80.6021	80.6022	80.6023	80.6024	80.6025	80.6026
285x280x200	80.6031	80.6032	80.6033	80.6034	80.6035	80.6036
285x280x260	80.6041	80.6042	80.6043	80.6044	80.6045	80.6046

Sicherheitsdeckel / Safety lid / Couvercle de sécurité / Tapa di seguridad / Coperchio di sicurezza



285x280	80.6001SL	80.6002SL	80.6003SL	80.6004SL	80.6005SL	80.6006SL
---------	-----------	-----------	-----------	-----------	-----------	-----------

Zubehör · Accessories · Accessoires · Accesorios · Accessori

für
1/2 Container

for
1/2 Containers

pour
1/2 Containers

para
1/2 Contenedores

per
1/2 Contenitori



Siebkörbe
Wire baskets
Plateaux inox
Bandejas inoxidable
Cestelli in acciaio fino

80.6203 255x245x 30 mm
80.6205 255x245x 50 mm
80.6207 255x245x 70 mm
80.6210 255x245x100 mm

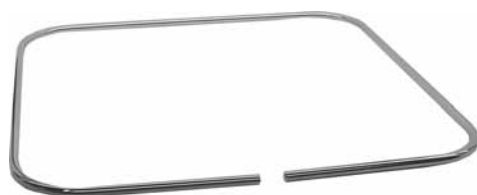

Spannrahmen
Cloth fixing frames
Cadres fixe-toile
Cuadros para fijar panos
Telai fissateli

80.6231 255x255 mm



80.6232 255x255x30 mm



Teiler
Deviders
Cloisons
Tabiques
Divisori

80.6240 255x245x130 mm

3/4 Container, ALU

Deckel gelocht und farbig
 Lid perforated and colored
 Couvercle perforé et coloré
 Tapas perforadas y coloreadas
 Coperchio perforato e colorato

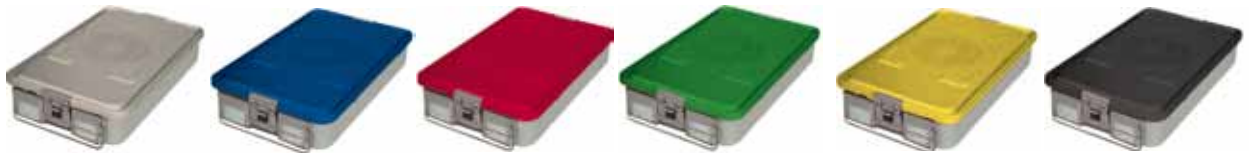

L x B x H mm

465x280x100	80.6301	80.6302	80.6303	80.6304	80.6305	80.6306
465x280x135	80.6311	80.6312	80.6313	80.6314	80.6315	80.6316
465x280x150	80.6321	80.6322	80.6323	80.6324	80.6325	80.6326

Sicherheitsdeckel / Safety lid / Couvercle de securité / Tapa di seguridad / Coperchio di sicurezza



465x280	80.6301SL	80.6302SL	80.6303SL	80.6304SL	80.6305SL	80.6306SL
---------	-----------	-----------	-----------	-----------	-----------	-----------

Zubehör · Accessories · Accessoires · Accesorios · Accessori

für
3/4 Container

for
3/4 Containers

pour
3/4 Containers

para
3/4 Contenedores

per
3/4 Contenitori

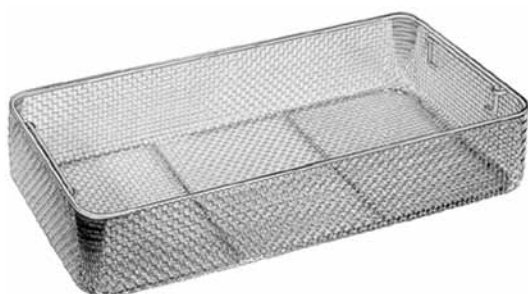

Siebkörbe
Wire baskets
Plateaux inox
Bandejas inoxidable
Cestelli in acciaio fino

80.6503	405x245x 30 mm
80.6505	405x245x 50 mm
80.6507	405x245x 70 mm
80.6510	405x245x100 mm



Spannrahmen
Cloth fixing frames
Cadres fixe-toile
Cuadros para fijar panos
Telai fissateli

80.6531	405x255 mm
---------	------------



80.6532	405x255x30 mm
---------	---------------

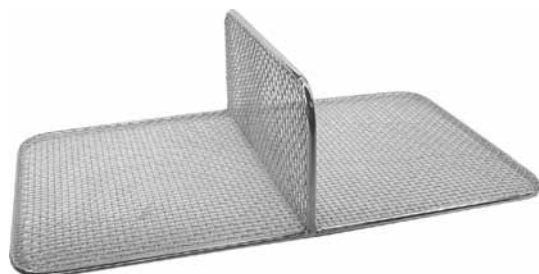

Teiler
Deviders
Cloisons
Tabiques
Divisori

80.6540	405x250x130 mm
---------	----------------



80.6541	405x250x130 mm
---------	----------------

1/1 Container, ALU

Deckel gelocht und farbig
 Lid perforated and colored
 Couvercle perforé et coloré
 Tapas perforadas y coloreadas
 Coperchio perforato e colorato



L x B x H mm

580x280x100	80.6601	80.6602	80.6603	80.6604	80.6605	80.6606
580x280x135	80.6611	80.6612	80.6613	80.6614	80.6615	80.6616
580x280x150	80.6621	80.6622	80.6623	80.6624	80.6625	80.6626
580x280x200	80.6631	80.6632	80.6633	80.6634	80.6635	80.6636
580x280x260	80.6641	80.6642	80.6643	80.6644	80.6645	80.6646

Sicherheitsdeckel / Safety lid / Couvercle de sécurité / Tapa di seguridad / Coperchio di sicurezza



580x280

80.6601SL	80.6602SL	80.6603SL	80.6604SL	80.6605SL	80.6606SL
-----------	-----------	-----------	-----------	-----------	-----------

Zubehör · Accessories · Accessoires · Accesorios · Accessori

für
1/1 Container

for
1/1 Containers

pour
1/1 Containers

para
1/1 Contenedores

per
1/1 Contenitori

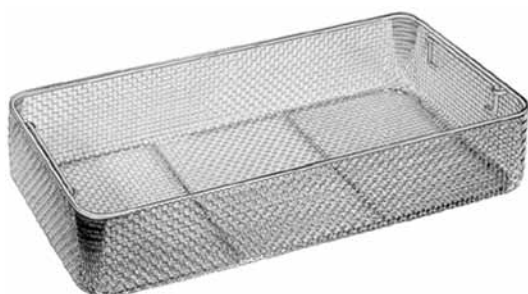

Siebkörbe
Wire baskets
Plateaux inox
Bandejas inoxidable
Cestelli in acciaio fino

80.6803	485x285x 30 mm
80.6805	485x285x 50 mm
80.6807	485x285x 70 mm
80.6810	485x285x100 mm
80.6813	540x285x 30 mm
80.6815	540x285x 50 mm
80.6817	540x285x 70 mm
80.6820	540x285x100 mm



Spannrahmen
Cloth fixing frames
Cadres fixe-toile
Cuadros para fijar panos
Telai fissateli

80.6841	545x245 mm
---------	------------



80.6842 5	45x245x30 mm
-----------	--------------



Teiler
Deviders
Cloisons
Tabiques
Divisori

80.6850	510x250x130 mm
---------	----------------

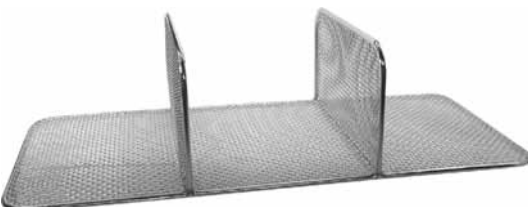

80.6851	510x250x130 mm
---------	----------------

Flach- und Mini-Container, ALU eloxiert

Flat- and Mini-Containers, ALU

Containers plates et mini en alumium

Contenedores planos y mini de aluminio

Contentori piatti e mini in alluminio



Deckel gelocht und farbig
 Lid perforated and colored
 Couvercle perforé et coloré
 Tapas perforadas y coloreados
 Coperchio perforato e colorato



Flach – Flat – Plat – Plano – Platto



L x B x H mm

285x280x55	80.7001	80.7002	80.7003	80.7004	80.7005	80.7006
285x280x85	80.7011	80.7012	80.7013	80.7014	80.7015	80.7016



Mini

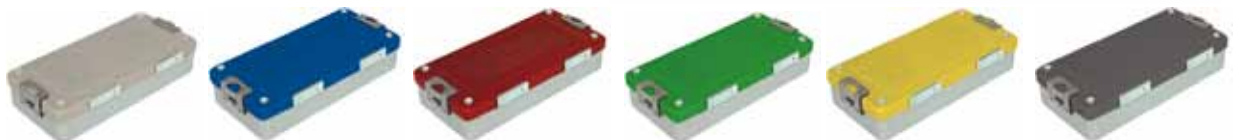

L x B x H mm

300x140x40	80.7301	80.7302	80.7303	80.7304	80.7305	80.7306
300x140x70	80.7311	80.7312	80.7313	80.7314	80.7315	80.7316
300x140x100	80.7321	80.7322	80.7323	80.7324	80.7325	80.7326

Zubehör · Accessories · Accessoires · Accesorios · Accessori

für FLACH- und
MINI-Container

for FLAT- and MI-
NI-Containers

pour Containers
PLARTS et MINI

para Contenedores
PLANOS y MINI

per Contenitori
PIATTI e MINI



Siebkorb mit Deckel
Wire basket with lid
Panier avec couvercle
Cestillo con cobertera
Cestello con coperchio

80.7410 267x125x50 mm



Siebeinlage f. MINI-Container
Separate base for MINI-Container
Fond du crible pour MINI-Container
Base para MINI-Container
Base per MINI-Container

80.7420 270x125 mm



Spannrahmen für Mini-Container
Cloth fixing frames for MINI-Container
Cadres fixe-toile pour MINI-Container
Cuadros para fijar panos para MINI-Container
Telai fissateli per MINI-Container

80.7431 270x125 mm

Endoskopie-Container, ALU eloxiert

Endoscopy-Containers, ALU

Containers para endoscopia en aluminium

Contenedores para endoscopia de aluminio

Contentitori per endoscopia in alluminio

Deckel gelocht und farbig

Lid perforated and colored

Couvercle perforé et coloré

Tapas perforadas y coloreados

Coperchio perforato e colorato

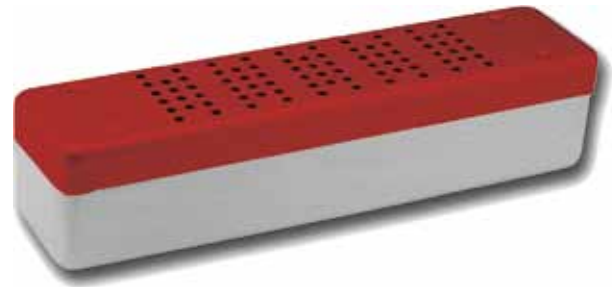

L x B x H mm

250x60x50

80.7501

80.7503

80.7504

450x70x70

80.7511

80.7513

80.7514

Zubehör · Accessories · Accessoires · Accesorios · Accessori

Siebköbe Endoskopie

Wire baskets Endoscopy

Paniers Endoscopie

Cestillos Endoscopia

Cestilli Endoscopia

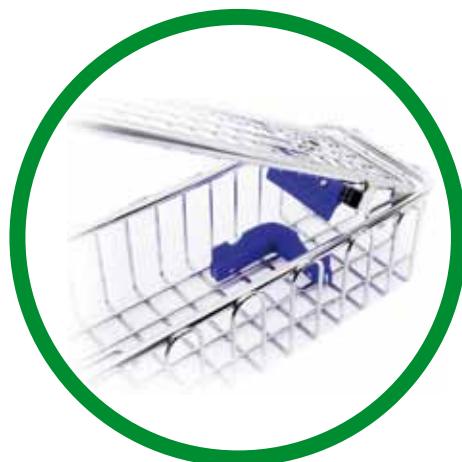

80.7551 290x 80x50 mm

80.7552 460x 80x50 mm

80.7553 640x150x77 mm

Zubehör · Accessories · Accessoires · Accesorios · Accessori

Kennzeichnungsschilder, Aluminium ohne Text
Identification labels, aluminium, neutral
Plaquettes d'identificationen aluminium, neutres
Placas de identificación, aluminio, neutral
Targhette di identificazione d'alluminio, neutre



80.7901 80.7902 80.7903 80.7904 80.7905 80.7906

Kennzeichnungsschilder, Aluminium graviert
Identification labels, aluminium, engraved
Plaquettes d'identificationen aluminium, gravées
Placas de identificación, aluminio, grabadas
Targhette di identificazione d'alluminio, incise



80.7911 80.7912 80.7913 80.7914 80.7915 80.7916

Sortiermagazin für Kennzeichnungsschilder
Rack for identification labels
Magasin à plaquettes d'identification
Cajita para seleccionar placas
Cassetta da selezione targhette

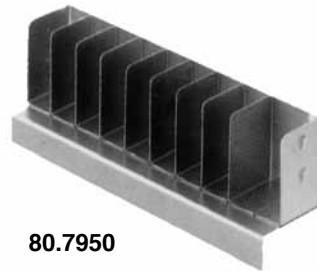

80.7950

Indikator-Schilder, Papier, 100 St.
Indicating labels, paper, 100 pcs.
Etiquettes d'identification en papier, les 100
Etiquetas indicadoras, papel 100 c/u
Targhette con indicatore, papel, 100 pezzi



80.7960

klein / small / petite / pequenas / piccolo

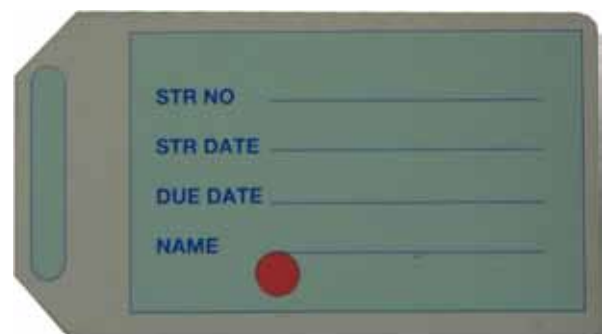

80.7962

groß / large / grande / grande / grande

Sicherungsplomben, Plastik, 100 St.
Safety Seals, plastic, 100 pcs.
Scellés de sécurité, plastique, les 100
Precintos de seguridad,plastico 100 c/u
Sigilli di sicurezza, plastica, 100 pezzi



80.7980

Zubehör · Accessories · Accessoires · Accesorios · Accessori

Filterspender für 1/2, 3/4, 1/1 Container-Filter
Filter Dispenser for 1/2, 3/4, 1/1 Container-Filters
Présentoir de filtres pour les 1/2, 3/4, 1/1 Containers
Distribuidor de filtros para los 1/2, 3/4, 1/1 Containers
Distributore di filtri per 1/2, 3/4, 1/1 Container



80.8000

Filterhalter für 1/2, 3/4, 1/1 Container
Filter Holder for 1/2, 3/4, 1/1 Containers
Fixe-filtres pour 1/2, 3/4, 1/1 Containers
Sujetafiltros para los 1/2, 3/4, 1/1 Containers
Fermafiltro per 1/2, 3/4, 1/1 Container



80.8010

Filter, Einmalgebrauch, Papier 1000 St.
Single use filters, paper 1000 pcs.
Filtres en papier à usage unique, les 1000
Filtros, monouso, papel, 1000 c/u
Filtri, monouso, carta, 1000 pezzi

FILTER, Papier für 1/2, 3/4, 1/1 Container
for 1/2, 3/4, 1/1 Containers
pour 1/2, 3/4, 1/1 Containers
para los 1/2, 3/4, 1/1 Containers
per 1/2, 3/4, 1/1 Container



80.8050

FILTER, Papier für MINI-Container
for MINI-Containers
pour MINI-Containers
para MINI-Containers
per MINI-Containers

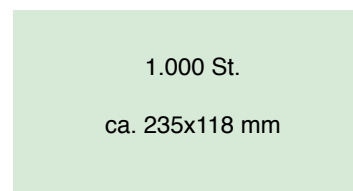

80.8052

FILTER, Papier für DENTAL Container
for DENTAL-Containers
pour DENTAL-Containers
para DENTAL-Containers
per DENTAL-Containers

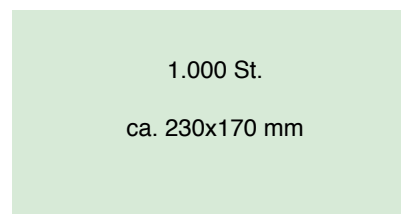

80.8054

Zubehör · Accessories · Accessoires · Accesorios · Accessori

Langzeit-Textilfilter, 1 St.
Long-term textile filters, 1 pc.
Filtres en textile, la pièce
Filtros de textil, 1 c/u
Filtri tessili, il pezzo

FILTER, Textil für 1/2, 3/4, 1/1 Container
for 1/2, 3/4, 1/1 Containers
pour 1/2, 3/4, 1/1 Containers
para los 1/2, 3/4, 1/1 Containers
per 1/2, 3/4, 1/1 Container

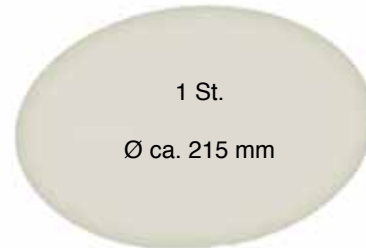

80.8060

FILTER, Textil für MINI-Container
for MINI-Containers
pour MINI-Containers
para MINI-Containers
per MINI-Containers

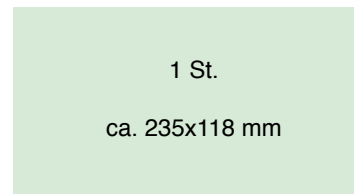

80.8062

FILTER, Textil für DENTAL Container
for DENTAL-Containers
pour DENTAL-Containers
para DENTAL-Containers
per DENTAL-Containers

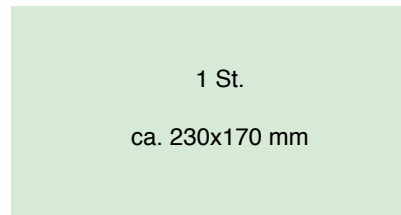

80.8064

Sterilisier-Tücher, Baumwolle
Sterilizing Drapes, cotton
Champs à stérilisation, coton
Paños de esterilización de algodón
Pannos di sterilizzazione, cotone

80.8100 40 x 60 cm
80.8105 85 x 85 cm
80.8110 100 x 140 cm
80.8115 275 x 125 cm
80.8120 245 x 245 cm



80.8100-
80.8120

Noppenmatten, Silikon
Silicone Pads
Tapis port-instruments, silicone
Tapices porta instrumentos de silicona
Tapetti porta-strumenti in silicone

80.8131 275 x 125 mm
80.8132 225 x 225 mm
80.8133 300 x 300 mm



80.8131-
80.8133

Zubehör · Accessories · Accessoires · Accesorios · Accessori

Fixierklammern für Tücher
Fixation Clamps for Drapes
Pinces fixe-toiles
Grapas para fijar paños
Pinze di fillaggio per teli



80.8150



- 80.8160** Ø 7 - 12 mm
- 80.8161** Ø 12 - 16 mm
- 80.8162** Ø 16 - 26 mm
- 80.8163** Ø 26 - 36 mm
- 80.8164** Ø 36 - 45 mm



**80.8160-
70.8164**

Fixierfedern
Spiral Supports
Ressorts spiraux
Apoyos con resorte spiral
Supporte a molle

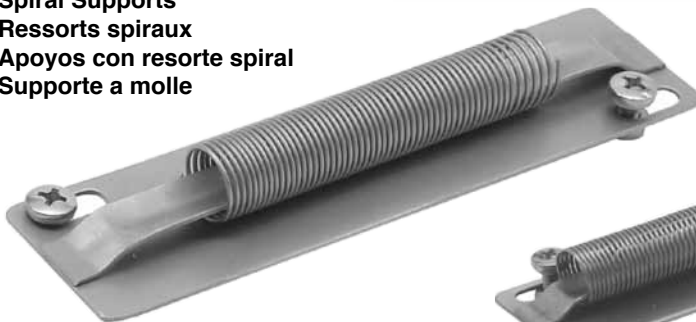

80.8191 115 x 30 mm



80.8192 230 x 30 mm

80.8140 SILIKON Fixierstreifen Set

bestehend aus:

- 80.8141 1 Silikon Streifen 246 x 13 mm
- 80.8142 2 Silikon Halteknöpfe

SILICONE Storage Strip Set

consisting of:

- 80.8141 1 Silicone Storage Strip 246x13 mm
- 80.8142 2 Silicone Fastening Knobs

SILICONE bande porte instrum. 243 x 13 mm

Jeu comprenant:

- 80.8141 1 Silicone bande à sécurité 243 x 13 mm
- 80.8142 2 Silicone boutons à fixation

SILICONE tira de protección 243 x 13 mm

Juego compuesto de:

- 80.8141 1 Silicone tira de protección 243 x 13 mm
- 80.8142 2 Silicone botones de fijar

SILICONE strisce per assicurare 243x13 mm

Set composto da:

- 80.8141 1 Silicone strisce per assicurare 243x13 mm
- 80.8142 2 Silicone botoni di fissare



80.8141 246x13 mm



80.8142 2 Stück / 2 pieces / 2 pièces / 2 piezas / 2 pezzi

Zubehör · Accessories · Accessoires · Accesorios · Accessori

Haltestifte, Trennbleche
Fixing bolts, Dividers
Attaches de fixation, Séparateurs
Piñons para fijar, Separadores
Perne di fissaggio, Divisori

Haltestift für Instrumente
for instruments
pour instruments
para instrumentos
per strumenti



80.8201

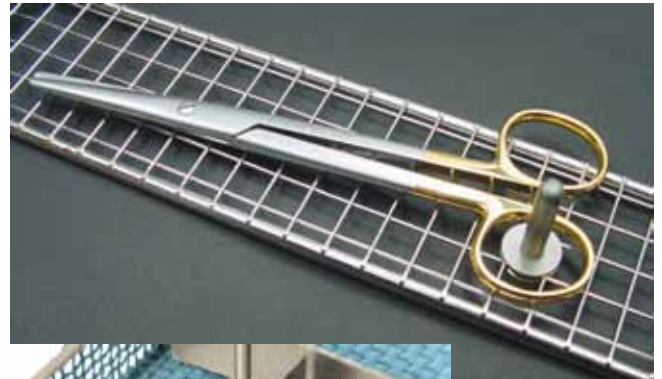

Haltestift für Trennbleche
for Dividers
pour Séparateurs
para Separadores
per Divisori



80.8202

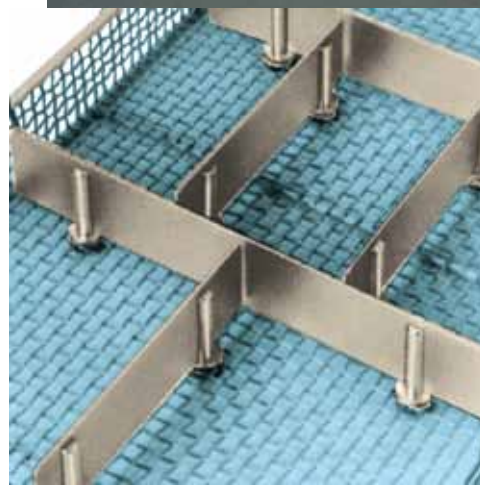

Trennbleche
Dividers
Séparateurs
Separadores
Divisori

80.8211 50x20 mm
80.8212 130x20 mm
80.8213 225x20 mm
80.8214 460x20 mm



Winkelbleche
Angled Dividers
Séparateurs angulés
Separadores angulados
Divisori angulate

80.8221 110 mm
80.8222 170 mm
80.8223 230 mm
80.8223 470 mm

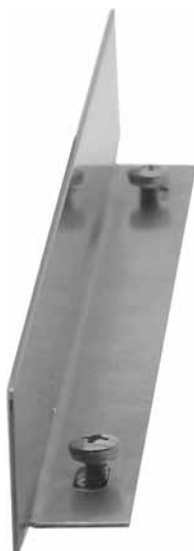

Sterilisierahmen für 8 Mikro-Instrumente
Sterilizing Rack for 8 Micro-Instruments
Chevalet à Sterilisation pour 8 Micro-Instruments
Porta-instrumentos para 8 Micro Instrumentos
Telaio per sterilizzazione per 8 micro-strumenti

80.3190 190 x 36 x 35 mm

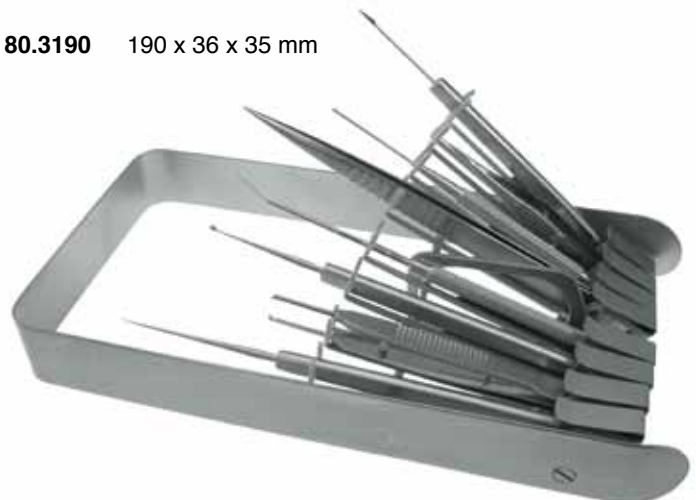

Sterilisation · Sterilization · Sterilisation · Esterilizacion · Sterilizzazione

Container für mikrochirurgische Instrumente
 Containers for microsurgical instruments
 Containers pour instruments de microchirurgie
 Contenedores para instrumental microcirugia
 Contenitori per strumenti per microchirurgia



80.3112 300x220x55 mm
80.3114 285x280x55 mm
80.3116 400x290x55 mm



80.3162 300x220x75 mm
80.3164 285x280x75 mm
80.3166 400x290x75 mm

Sterilisiertrommeln
 Sterilizing drums
 Boites rondes à sterilisation
 Tambores de esterilizacion
 Cestelli rotondi per sterilizzazione

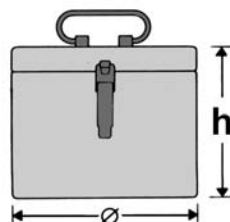

SCHIMMELBUSCH

80.4002	120x120 mm	80.4016	240x240 mm
80.4004	140x140 mm	80.4018	290x160 mm
80.4006	160x120 mm	80.4020	290x240 mm
80.4008	160x150 mm	80.4022	340x160 mm
80.4010	190x150 mm	80.4024	340x240 mm
80.4012	190x190 mm	80.4026	390x190 mm
80.4014	240x160 mm	80.4028	390x290 mm



**80.4002-
80.4028**

KONRICH

80.4040	96 x 99 mm	80.4054	285 x 240 mm
80.4042	156 x 146 mm	80.4056	334 x 158 mm
80.4044	188 x 140 mm	80.4058	334 x 238 mm
80.4046	188 x 185 mm	80.4060	384 x 138 mm
80.4048	239 x 160 mm	80.4062	384 x 188 mm
80.4050	239 x 240 mm	80.4064	384 x 288mm
80.4052	285 x 160 mm		



**80.4040-
80.4064**

Zubehör · Accessories · Accessoires · Accesorios · Accessori

Pflegeöl für chirurgische Instrumente
Lubricating Oil for Surgical Instruments
Huile pour lubrifier les instruments chirurgicaux
Lubrificante para las instrumentos quirúrgicos
Olio per lubrificazione di strumenti chirurgici

80.0010 50 cc.
80.0012 250 cc.
80.0014 1000 cc.



80.0010

Wattespender
Cotton dispensers
Distributeurs de coton
Dispensores de algodón
Distributore del cotone

80.1000 75 x 50 Ø
80.1002 115 x 75 Ø



80.1000-
80.1002

Watteabfallbehälter
Cotton Waste Collector
Poubelle pour coton
Recipiente para algodón
Recipiente per cotone usato

80.1010 75 x 50 Ø
80.1012 100 x 75 Ø



80.1010-
80.1012

Nadeldosen
Needle Cases
Boîtes à aiguilles
Estuches para agujas
Astucci per aghi

80.2000 65x17 mm
komplett - complete - complet - completo - completo



80.2000

80.2009 Innendose allein für 80.2000
insert only for 80.2000
boîte int Érieure seulement pour 80.2000
Caja interior suelta para 80.2000
Scatola interna sola per 80.2000

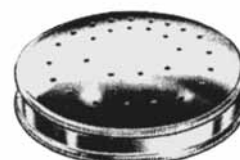

80.2009

Zubehör · Accessories · Accessoires · Accesorios · Accessori

80.2020 150x95x13 mm



80.2020

80.2030 50x25x4,5 mm

80.2031 65x42x8,0 mm

80.2032 75x25x4,5 mm

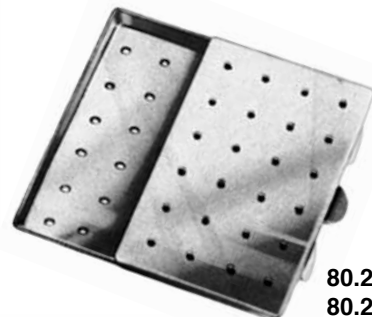

**80.2030-
80.2032**

SAUERBRUCH

80.2060



80.2060

Meßbecher
Measuring jugs
Gobelets gradués
Copas graduadas
Misurini

80.2070 0,25 l.

80.2072 0,5 l.

80.2074 1,0 l.

80.2076 1,5 l.

80.2078 2,0 l.



80.2070 -80.2078

Petrischale
Petri Dish
Boîte de Petri
Cubeta de Petri
Scodella di Petri

80.2090 100 X 20 mm



80.2090

Zubehör · Accessories · Accessoires · Accesorios · Accessori

Nierenschalen
Kidney bowls
Bassins réniformes
Riñoneras
Padelle reniformi

80.2100	170 x 37 mm
80.2101	205 x 45 mm
80.2102	250 x 39 mm
80.2104	275 x 45 mm



80.2100 -
80.2104

Runde Schalen
Round Bowls
Cuvettes rondes
Cubetas redondas
Scodelle rotonde

80.2200	40 x 19 mm	0,05 l
80.2202	60 x 30 mm	0,07 l
80.2204	80 x 40 mm	0,14 l
80.2206	100 x 50 mm	0,20 l
80.2208	120 x 55 mm	0,35 l
80.2210	150 x 65 mm	0,70 l



80.2200 -
80.2210

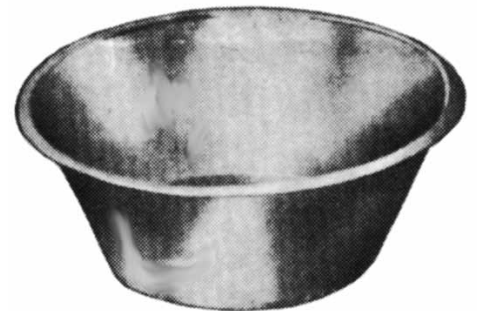

80.2240 -
80.2262

80.2240	150 x 74 mm	0,75 l
80.2242	160 x 65 mm	1,00 l
80.2244	220 x 70 mm	2,00 l
80.2246	225 x 90 mm	2,50 l
80.2248	240 x 95 mm	3,00 l
80.2250	255 x 115 mm	4,00 l
80.2252	260 x 130 mm	4,50 l
80.2254	300 x 105 mm	6,00 l
80.2256	310 x 120 mm	6,00 l
80.2258	320 x 140 mm	8,00 l
80.2260	380 x 125 mm	11,00 l
80.2262	400 x 150 mm	14,00 l

Kappenzangen mit Behälter und Deckel
Sterilizing Forceps with jar and lid
Pincas à stérilisation avec éprouvette et couvercle
Pinzas para esterilización con recipiente y tapa
Pinze per sterilizzazione con recipiente e coperchio

80.2270	25 cm
80.2272	32 cm



80.2270 -
80.2272

Zubehör · Accessories · Accessoires · Accesorios · Accessori

Standgefäße

Jars

Récipients cylindriques

Tarros

Recipienti cilindrici

80.2280	30 x 90 mm
80.2282	50 x 100 mm
80.2284	50 x 135 mm
80.2286	50 x 180 mm
80.2288	80 x 130 mm
80.2290	80 x 180 mm
80.2292	100 x 200 mm



**80.2280 -
80.2292**

Medizinbecher und -löffel

Medicine Cups and Spoons

Gobelets et cuillère à médicaments

Vasos y cuchara para medicamentos

Bicchieri e cucchiaio per medicinali

80.2300	30 cc
80.2302	50 cc



80.2300



80.2302

80.2310	6,8 x 1,8 cm
----------------	--------------



80.2310

80.2315	11 x 2 cm
----------------	-----------



80.2315

Zubehör · Accessories · Accessoires · Accesorios · Accessori

Instrumenttenablegeplatten
Instrument depositing trays
Plateaux pour déposer les instruments
Bandejas para instrumentos
Vassoi per strumenti

80.2400	210 x 160 x 10 mm
80.2401	240 x 180 x 10 mm
80.2402	310 x 150 x 10 mm
80.2406	310 x 210 x 10 mm
80.2407	400 x 270 x 20 mm
80.2408	420 x 280 x 10 mm

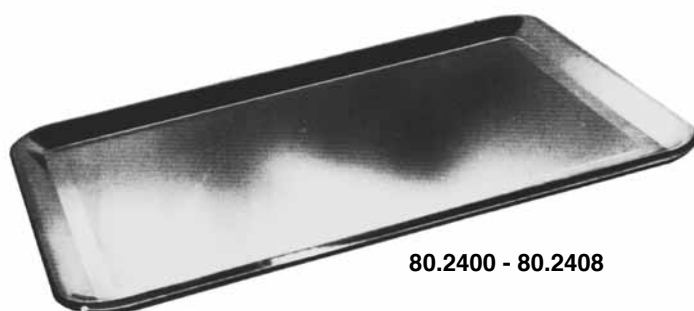

80.2400 - 80.2408

80.2430	230 x 155 x 30 mm
80.2432	300 x 175 x 30 mm
80.2434	300 x 175 x 40 mm
80.2436	350 x 240 x 36 mm
80.2438	400 x 300 x 50 mm



80.2400 - 80.2408

Instrumentenkästen
Instrument Boxes
Boîtes à Instruments
Cajas para instrumentos
Cestelli per strumenti

80.4100	16x10x 3 cm
80.4101	20x10x 5 cm
80.4102	22x15x 5 cm
80.4103	26x15x 5 cm
80.4104	30x20x 5 cm



80.4100 - 80.4104

INHALTSVERZEICHNIS

A

ABDOMINAL Spekulum	336
Abortuskürette	189
Abortuslöffel	189
Abortuszangen	187,191
Absaugküretten	170
ADAIR Hakenzangen	134
Adapter für Kaltlichtgriff	55
ADLERKREUTZ chirurgische Pinzetten	246
ADSON anatomische Pinzetten	235,236
ADSON anatomische Pinzetten PROMEDUR	253
ADSON Arterienklemmen	277
ADSON chirurgische Pinzetten	241,242
ADSON chirurgische Pinzetten PROMEDUR	253
ADSON Nadelhalter	360
ADSON Pinzetten mit LOCHGRIFF	235
ADSON-BABY Arterienklemmen	277
ADSON-BROWN chirurgische Pinzetten	246
ADSON-BROWN chirurgische Pinzetten PROMED	255
ADSON-DEBAKEY atraumatische Pinzetten	235
ADSON-GRAEFE chirurgische Pinzette	242
ADSON-MIKRO anatomische Pinzetten	235
ADSON-MIKRO chirurgische Pinzetten	241
ADSON-SELECT chirurgische Pinzetten	241
ALAN-PARKS Rektalspreizer	50
ALEXANDER Biopsiezange	157
ALLEN Kinderdarmklemme	27
Allgemeine Instrumente	193-372
ALLIS atraumatische Klemmen	28
ALLIS Gewebefaßklemmen	27-31
ALLIS-ADAIR Gewebefaßklemme	28
ALLIS-BABY Gewebefaßklemmen	27
AMANN Tamponadeführer	131
Amnioskope	172
Amniotom	131
Anaesthesie-Kanüle	188
Analpreizer	50,51
Anastomosenklemmen	46
anatomische Pinzetten	235-240
anatomische Pinzetten für bariatrische Chirurgie	239
anatomische Pinzetten PROMEDUR	253
ANDREW-PYNCHON Saugkanüle	367
Anschlußkabel für bipolare Pinzetten	266
Anschlußkabel für bipolare Scheren	232
Anuskope, Rektuskope, Proktoskope	54-57
Appendektomieklammer	45
Arterienklemmen, Präparierklemmen	237-293
AUVARD Vaginalsepekula	116

B

BABCOCK Gewebefaßklemmen	29,30,293
BABCOCK Gewebefaßklemmen PROMEDUR	30
BABCOCK-DEBAKEY Klemmen	30
BABY-ADSON Arterienklemmen	277
BABY-ALLIS Gewebefaßklemmen	27
BABY-BALFOUR Bauchdeckenhalter	328
BABY-COLLIN Bauchdeckenhalter	324
BABY-CRILE Arterienklemmen	275
BABY-CRILE-WOOD Nadelhalter PROMEDUR	353
BABY-GELPI Wundsperrer	322
BABY-KOCHER Darmklemmen	33
BABY-LEXER Präparierscheren	218
BABY-METZENBAUM Präparierscheren	218
BABY-MIKULICZ Peritoneumklemme	146
BABY-MIXTER Arterienklemmen	285
BABY-OVERHOLT Arterienklemmen	283
BABY-PAYR Darmquetschklemme	44
BACKHAUS Tuchklemmen	297
BAINBRIDGE Arterienklemmen	279
BAKES Gallengangsonden	76
BALFOUR Bauchdeckenhalter	328-330
BALFOUR Mittelblätter	330

Seite

BALFOUR Seitenarme	330
BALFOUR-BABY Bauchdeckenhalter	328
BALFOUR-Modif. Bauchdeckenhalter	330
BALL & SOCKET Tuchklemmen	298
BALLENGER Schwammzangen	300
BARNES-NEVILLE Geburtszange	184
BARR Analspreizer	51
BARRET Hakenzange	133
BARRON Hämorrhoidal Ligator	68
BARRON Hämorrhoiden Faßzange	70
BARRON Skalpellgriff	203
BARTON Geburtszange	183
BARTON Zughebel	183
Batteriegriffe für Anuskope/Proktoskope	55
Bauchdeckenhalter	324-341
Bauchdeckenspekulum	336
BEACHAM Amniotom	131
Beckenzirkel	20,177
BENGOLEA Arterienklemmen	278
BENSAUDE Anuskope	53
BENSON Pyloruspreizer	45
BERGER Biopsiezangen	161
BERGMANN-FOERSTER Schwammzangen	300
BERKELEY-BONNEY Hysterektomieklammer	150
BERNHARD Tuchklemme	298
Beschneidungsgerät	103
BILL Zughebel	184
Biopsieküretten	162-163
Biopsiezangen für Rektum	71
BIPOLAR Pinzetten	257-265
BIPOLAR Scheren	228-230
BIPOLAR Scheren-Klemmen	231
BIPOL-Kabel für "BiTech" Scheren	232
BIPOL-Kabel für Bipolpinzetten	266
BiTech Bipol-Scheren	228-230
BLAKE Gallensteinzangen	81
BLAKE Uteruskürette doppelendig	164
BLANK atraumatische Pinzetten	237
Blasenhalsspreizer	96,100
Blasensprenger	188
Blasenwundspreizer	100,101
BLESSING Rektumschere	60,225
BLOND Anuskope	56
BLOND Proktoskop-Tubus	56
Blutdruckmesser	11,196,197
Blutdruckmesser, Manschetten	11,197
BODENHAMMER-SIMS Mastdarmspekulum	49
BOERMA Geburtszange	181
BONNEY anatomische Pinzette	238
BONNEY anatomische Pinzetten PROMEDUR	254
BONNEY chirurgische Pinzetten	246
BONNEY chirurgische Pinzetten PROMEDUR	255
BOYNTON Nadelhalter	345
BOYS-ALLIS Gewebefaßklemme	28
BOZEMANN Nadelhalter	360
BOZEMANN Nadelhalter PROMEDUR	355
BOZEMANN Schwammzangen	304
BOZEMANN Uterusschere	179
BOZEMANN-DOUGLAS Schwammzange	304
BRAUN Dekapitationshaken	186
BRAUN Hakenzangen	133
BRAUN Kranioklast	186
BRAUN Uterusdepressor	131
BRAUN-STADLER Episiotomie-Scheren	180
BREISKY Scheidenhalter	124
BRIDGE Arterienklemmen	279
BROMPTON Schlauchroller	299
BROPHY anatomische Pinzetten	237
BROPHY chirurgische Pinzetten	244
BROWN chirurgische Pinzetten	247
BRYANT Tupferzange	302
BUIE Druckklemme	43
BUIE Fistelsonde	63
BUIE Rektal-Absaugrohr	64
Bulldogklemmen	269-272

Seite

	Seite		Seite
BUMM Uterusküretten	167,168	DEAVER Wundhaken	314-316,317
BUMM Uterus-Polypenzange	143,190	DEBAKEY atraumatische Pinzetten	250-252
BUNT Sterilisierklammer	375	DEBAKEY Bulldogklemmen	272
Bürstenspender	23	DEBAKEY Gallengangschere	84
BUSCH Nabelschnurschere	179	DEBAKEY Gewebe- und Organfaßzangen	32,83
C			
CARREL Arterienklemme	273	DEBAKEY Nadelhalter PROMEDUR	354
CASTROVIEJO Nadelhalter	345	DEBAKEY Pinzette für bariatrische Chirurgie	240
CASTROVIEJO Nadelhalter PROMEDUR	345	DEBAKEY Pinzetten PROMEDUR	254
CHAPUT Arterienklemme	27	DEBAKEY Saugkanülen	368
CHARNLEY Wundspreizer	341	DEBAKEY Wundsperrer	321
CHEATLE Sterilisierzange	374	DEBAKEY-BABCOCK Klemmen	30
CHERON Schwammzange	304	DEBAKEY-DOYEN Darmklemmen	37
Chirurgische Pinzetten	243-249	DEBAKEY-FEHLAND Darmklemme	39
Chirurgische Pinzetten für bariatrische Chirurgie	239	DEBAKEY-HAYES Darmklemmen	39
Chirurgische Scheren	215	DEBAKEY-KOCHER Darmklemmen	38
Chirurgische Scheren für Linkshänder	215	DEBAKEY-MIKRO atraumatische Pinzetten	251
CLAR Stirnspiegel	14,15	DEBAKEY-MIKRO Bulldogklemmen	272
COLLER-CRILE Arterienklemmen	276,287	DEBAKEY-SCUDDER Darmklemmen	41
COLLIN Bauchdeckenhalter	324	DEMARTEL Gallengangschere	84
COLLIN Beckenzirkel	20,177	DEMARTEL-WOLFSON Anastomosenklemmen	46
COLLIN Dynamometer	19	DENIS-BROWN Bauchdeckenhalter	331
COLLIN Gewebefaßfazzange	31	DENIS-BROWN Bauchdeckenhalter für Kinder	331
COLLIN Kornzange	304	DENIS-BROWN Darmfasspinzette	249
COLLIN Nabelschnurklemme	185	DESJARDINS Gallenkanalklemmen	79
COLLIN Skalpellgriffe	202,204	DESJARDINS Gallensteinsonden	75
COLLIN Uterusfazzange	141	DESJARDINS Gallensteinzangen	81
COLLIN Vaginalsepekula	112	DEWEY Geburtszange	183
COLLIN Vaginalsepekula, blendfrei für Laserchirurgie	112	Diagnostik	7-15, 195-198
COLLIN Vaginalsepekula, isoliert für HF-Chirurgie	112	DICK Klemmzangen	148
COLLIN Vaginalsepekulum für Kinder	107	DIETRICH Bulldogklemmen	271
COLLIN-BABY Bauchdeckenhalter	324	Dilatations-Bougies	104
COLLIN-DUVAL Fasspinzetten	249	DOUAY Biopsiezangen	157
COLLIN-LOCKTITE Bauchdeckenhalter	325	DOYEN Bauchdeckenhalter	336
COLLYER Beckenzirkel	20,177	DOYEN Darmklemmen	33
COOLEY atraumatische Pinzetten	251	DOYEN gynäkologische Scheren	179
COOLEY Saugkanülen	369	DOYEN Hohlsonde	366
Coronarscheren	210	DOYEN Myomheber	145
COUPLAND Saugkanüle	367	DOYEN Polypenzangen	82
CRAFOORD Arterienklemmen	281	DOYEN Scheidenspekula	125
CRAFOORD Operationsschere	221	DOYEN Uterus-Polypenzange	142,190
CRAFOORD-SELLORS Arterienklemmen	281,289	DOYEN Wundhaken	312
CRILE Arterienklemmen	275	DOYEN-DEBAKEY Darmklemmen	37
CRILE Nadelhalter	359	DOYEN-STILLE Wundhaken	312
CRILE-BABY Arterienklemmen	275	Druckklemmen	43
CRILE-COLLER Arterienklemmen	276	DUBOIS Kephalotomiescheren	180,186
CRILE-MURRAY Nadelhalter	359	DUEHRSEN anatomische Pinzetten	238
CRILE-RANKIN Arterienklemmen	276	DUEHRSEN chirurgische Pinzette	245
CRILE-WOOD Nadelhalter	359	DUNHILL Arterienklemmen	275
CRILE-WOOD Nadelhalter PROMEDUR	353	DUPLAY Hakenzange	135
CRILE-WOOD-BABY Nadelhalter PROMEDUR	353	DUPLAY Kornzangen	303
CUSCO Vaginalsepekula	110,111	DUPLEX Stethoskope	12,198
CUSCO Vaginalsepekula, blendfrei für Laserchirurgie	111	DURANTE chirurgische Pinzetten	248
CUSCO Vaginalsepekula, isoliert für HF-Chirurgie	110	DUVAL atraumatische Darmklemmen	31
CUSCO Vaginalsepekula, schweizer Model	110	DUVAL Darmfasspinzette	249
CUSCO Vaginalsepekulum für Kinder	107	DUVAL Gewebefaßklemmen	31
CUSHING anatomische Pinzetten PROMEDUR	253	DUVAL Gewebefaßklemmen PROMEDUR	31
CUSHING Venenhaken	317	Dynamometer	19
CUZZI Abortuslöffel	189	E	
Cystikus-Haken	63	EASTMAN Scheidenspekula	123
CZERNY Hakenzange	133	EDNA (Lorna) Tuchklemmen	298
CZERNY Mastdarm-Valve	47	ELLIOT Geburtszangen	182
CZERNY Wundhaken	307	EMMET Fistelhaken	144
D			
DARLING Wundspreizer	321	EMMET Korn- u. Tupferzange	303
Darmklemmen	33-46	Empfohlene Operationsbestecke für GEBURTSHILFE	176
Darmquetschklemmen	44	Empfohlene Operationsbestecke für GYNÄKOLIGIE	106
Darmscheren	58,59,223	Empfohlene Operationsbestecke für LEBER, GALLE, NIERE	74
DARTIGUES Uterusfazzange	90,141	Empfohlene Operationsbestecke für MAGEN, DARM, MASTDARM	26
DAVIS Sterilisierpinzetten	374	Empfohlene Operationsbestecke für UROLOGIE	94
DE LEE Beckenzirkel	177	Endoskopie-Sterilisiercontainer	384
DE LEE Geburtszange	182	Endozervikalspreizer	127
		Episiotomiescheren	180
		EPPENDORF Biopsiezange	160
		ER.DE Manipulator	175

	Seite		Seite
EWALD anatomische Pinzette	235	GRAVE Vaginalsepekula, isoliert für HF-Chirurgie	113
EWALD chirurgische Pinzette	241	GRAY Gallenkanalklemmen	80
EXACTA Blutdruckmesser	10,196	GREEN Wundhaken	310
F		GREEN-ARMYTAGE Abortuszangen	187
Fadenzange	95	GREGORY Bulldogklemmen	270
FANSLER-IVES Anoskop mit Kaltlichtanschluss	54	GREGORY Mikronadelhalter	349
FANSLER-IVES Anuskope	53,54	GREGORY Mikronadelhalter DIAMANT	351
FAURE Biopsiezange	156	GREGORY Mikronadelhalter PROMEDUR	351
FAURE Peritoneumklemmen	147	GROSS Kornzangen	303
FEHLAND-DEBAKEY Darmklemme	39	GUNNAR-HEY Schlauchroller	299
feine Scheren	214	GUTTMAN Sekretlöffel	103
feine Scheren für Linkshänder	214	GUYON Dilatationsbougies	104
FERGUSSON Druckklemmen	43	GUYON Katheterspanner	102
FERGUSSON gynäkologische Schere	179	GUYON Nierenstielklemmen	88,291
FERRIS-SMITH chirurgische Pinzetten	244	GWILLIAM Hysterektomieklappen	150
Filter, Papier für Container	386	Gynäkologie	105-180
Filter, Textil für Container	387	Gynäkologische Scheren	178-180
Filterhalter für Container	386	H	
Filterspender für Container	386	Haemorrhoidal Fasszangen	70
FINOCHIETTO Nadelhalter	360	Hakenzangen	133-139
FINOCHIETTO Nadelhalter PROMEDUR	355	Halogen Stirnlampen	15
Fistel- und Myominstrumente	144,145	HALSTED Arterienklemmen	277
Fistelhaken	144	HALSTED-MOSQUITO Arterienklemmen	274
Fistelsonen	63,366	Haltestifte für Instrumente	389
Fixierfedern für Instrumente	388	Handwaschbürste	23
Fixierklammern für Tücher	388	HARRINGTON Bronchusklemme f. bariat. Chirurgie	292
Fixierklemme, Samenstrang	96	HARRISON Sterilisierzangen	374
Flach-Container	382	HARTMANN Arterienklemmen	273
FLETCHER (Javerts) Schwammzange	301	HARTMANN-MIKRO Arterienklemmen	273
FLETCHER Schwammzange	301	HAYES-DEBAKEY Darmklemmen	39
FOCUS Halogen-Stirnlampe	15	HEANEY (Hegar) Nadelhalter	361
FOERSTER Bauchdeckenhalter, röntgenfähig	337	HEANEY Hysterektomieklappen	149
FOERSTER Gallenblasenzangen	83,300	HEANEY Nadelhalter PROMEDUR	356
FOERSTER Schwammzangen	293,300,301	HEANEY-BALLENTINE Hysterektomieklappen	149
FORD-DIXON Hämorrhoidal Ligator	66	HEANEY-KANTER Hysterektomieklappen	149
FRANKLIN-SILVERMAN Leberpunktionskanülen	87	HEANEY-REZEK Hysterektomieklappen	149
Fremdkörperzangen	103	HEGAR Uterusdilatoren	128,129
FRIEDMANN (Joll) Wundspreizer	126,321	HEISS Arterienklemmen	278
FRITSCH Wundhaken	313	HENROTIN Hakenzange	137
FUCHSIG Arterienklemme	278	HERRICK Nierenstielklemme	88
G		HERTZLER Bauchdeckenhalter	328
Galle, Leger, Niere	73 - 92	HEYWOOD-SMITH Gallenblasenzangen	83
Gallenblasenzangen	83,300	HEYWOOD-SMITH Hämorrhoidalzange	70
Gallengangscheren	83	HEYWOOD-SMITH Uterus-Polypenzange	83,142,190
Gallengangsonden	76	HF-Chirurgie - Vaginalsepekula	111-114
Gallenkanalklemmen	79	HILL-FERGUSON Mastdarm-Valven	47
Gallensteinlöffel	77,78	HILL-FERGUSON Rektalspekula	47
Gallensteinsonden	75	HIRSCHMANN Anuskope	52
Gallensteinzangen	80-82	Hohlsonden	366
GAUSS Kopfschwartenzange	187	HOLZBACH Bauchdeckenhalter	326
Geburtshilfe	176-191	HORGAN Mittelvalven	330
Geburtszangen	181-184	HÖSEL Wundhaken	61
GELPI Wundsperrer	322,323	HRYNTSCHAK Blasenwundspreizer	101
GELPI-BABY Wundsperrer	322	HULKA Hakenzange	135
GELPI-MINI Wundsperrer	322	HULKA-KENWICK Hakenzange	135
GELPI-SELETZ Wundspreizer	323	Hysterektomieklappen	149-154
GEMINI Arterienklemmen	284,291,294	Hystero-Salpingograph	171
GEMINI-MINI Arterienklemmen	284	I	
GERALD chirurgische Pinzetten	244	Instrumenten-Pflegeöl	391
GERALD chirurgische Pinzetten PROMED	254	Instrumentenkästen	395
Gewebe- und Organfaßzangen	27-32	Indikatorschilder für Sterilisation	385
GILLIES chirurgische Pinzette	242	Infusionsflaschen-Öffnungszange	375
GILLIES chirurgische Pinzetten PROMED	254	Instrumentenbügel	375
GIL-VERNET Sinus Renalis Haken	91,92	Instrumentenschalen	395
GLASSMANN atraumatische Pinzetten	252	IOWA Blasensprenger	188
GLOVER Bulldogklemmen	269	IOWA Pudendus-Anaesthesiekanüle	188
GOELET Wundhaken	307	ISRAEL Wundhaken	309
GOODELL Uterus Dilator	129	IUP Haken zur Entfernung	132
GOSSET Bauchdeckenhalter	327	IUP-Fasszangen & Tupferträger	132
GOURDET Uteruslöffel	165		
GRAVE Vaginalsepekula	113,115		
GRAVE Vaginalsepekula, blendfrei für Laserchirurgie	113		

	Seite		Seite
J			
JACKSON Scheidenspekula	123	LAWRENCE Arterienklemme	285
JACKSON-BURROWS Wundreizer	323	Leberhaken	85
JACOBS Hakenzangen	138	Leberpunktionskanülen	87
JACOBSON-MIKRO Arterienklemmen	274	Lebertransplantationsklemmen	86
JARCHO Hakenzange	134	LEGUEU Blasenspatel	97
JEFFERSON anatomische Pinzette	236	LEGUEU Blasen-Wundspreizer	325
JEFFERSON chirurgische Pinzette	242	LERCHE chirurgische Pinzette	246
JOHN-HOPKINS Gallenkanalklemme	80	LEXER-BABY Präparierscheren	218
JOHNSON Nadelhalter	360	LICHTENBERG Nadelhalter PROMEDUR	358
JOLL (Friedmann) Wundspreizer	126,321	Lichtstab für Proktoskope, Anuskope, Spekula	50,53,109
JONES Tuchklemmen	297	LICHTWITZ Trokar	371
JUDD-ALLIS Gewebefaßklemmen	28	Linkshänder feine Arterienklemmen	274
JUDD-MASON Blasenwundspreizer	100,101	Linkshänder Nadelhalter	353,354
K			
Kabel für "BiTech" Scheren	232	Linkshänder Scheren	214,215
Kabel für bipolare Pinzetten	266	LISTER-SINUS Zängchen	302
KALLMORGEN Scheidenspekula und -halter	122	LITTAUER Nageleckenzangen	22
Kaltlichtgriff für Anuskope, Proktoskope	55	LITTLE Wundhaken	309
Kaltlicht-Klammer für Proktoskope	54,173	LITTLEWOOD Gewebefaßklemme	28
Kaltlichtquelle für Stirnlampen	15,57	LLOYD-DAVIS Rektum-Anastomosenklemme	43
Kaltlichtstab für Proktoskope, Anuskope, Spekula	50,53,109	LLOYD-DAVIS Rektumschere	59,223
KANE Nabelschnurklemme	185	LOCKHART-MUMMERY Fistelsonden	63,366
KANTROWITZ Arterienklemmen	284	LOCKWOOD Gewebefaßklemme	29
Kappenzangen	393	LORNA (Edna) Tuchklemmen	298
Kapselassenzangen	95	LOWER Gallenkanalklemme	80
Katheter für Frauen, Männer	102	LUER-KOERTE Gallensteinlöffel	78
Katheterspanner	102	LUIKART Geburtszange	182
KELLY Abortuszange	191	LUIKART-BILL Zughebel	184
KELLY Arterienklemmen	275	Lupenbrille	13
KELLY Leberhaken	85,311	LURZ Hämorrhoidal Saug-Ligatoren	66
KELLY Proktoskope	52	LURZ Ureterklemmen	96
KELLY Sphinkteroskope	52	M	
KELLY Wundhaken	85,311	Magen, Darm, Mastdarm	27-71
KELLY-RANKIN Arterienklemmen	276	MAIER Kornzangen	303
Kennzeichnungsschilder / Sterilisation	385	MAINGOT Hysterektomieklappen	150
Kephalotomiescheren	180,186	Manschetten für Blutdruckmesser	11,197
KERSTING atraumatische Darmklemme	40	MARBERGER Sinus Renalis Haken	91
KEVORKIAN Biopsieküretten	162	MARINUS Darmklemmen	42
KEVORKIAN Biopsiezangen	161	MARTEL Kopfschwartenzange	187
KEVORKIAN-PACIFIC Biopsiezange	158	MARTIN Abfallzange	374
KIELLAND Geburtszange	181	MARTIN Beckenzirkel	20,177
KIELLAND-LUIKART Geburtszange	182	MARTIN Uterussonden	130
KIRSCHNER Bauchdeckenhalter	332	Maßbänder	19
KLEINSCHMIDT Appendektomieklammer	45	MASSON Nadelhalter	361
Klemmzangen atraumatisch	148	MASSON Nadelhalter PROMEDUR	356
KLING-EX Klingentferner	205	Maßstäbe	19
KLINIKUM-BERLIN Schlauchklemme	299	Mastdarm-Spekula	47-51
Knopfsonden	365,366	Mastdarm-Valven	47
Koagulationspinzetten, bipolar	257-265	MATHIEU Fremdkörperzange	103
KOCHER Darmklemmen	34	MATHIEU Nadelhalter PROMEDUR	358
KOCHER Prostatahaken	97	MATHIEU Rektalspekulum	49
KOCHER-BABY Darmklemmen	33	MATHIEU-KOCHER Nadelhalter PROMEDUR	358
KOCHER-DEBAKEY Darmklemmen	38	MAYO Gallensteinlöffel	77
KOCHER-WAGNER Wundhaken	313	MAYO Operations- und Präparierscheren	216,222
KOERTE Wundhaken	308	MAYO Sterilisierklammern	375
KOGAN Endospekula	127	MAYO-ADAMS Bauchdeckenhalter	325
KONRICH Sterilisiertrömmeln	390	MAYO-BLAKE Gallensteinzangen	82
KRISTELLER Scheidenhalter für Kinder	108	MAYO-GUYON Nierenklemme	88
KRISTELLER Scheidenspekula und -halter	118,119,120,121,126	MAYO-HARRINGTON Operations- und Präparierscheren	217,224
KÜSTNER Hakenzange	139	MAYO-HEGAR Nadelhalter	359
L			
LAHEY Gallenkanalklemmen	79	MAYO-HEGAR Nadelhalter für Linkshänder	354
LAHEY Wundhaken	309	MAYO-HEGAR Nadelhalter PROMEDUR	354
LANDAU Scheidenhalter	124	MAYO-LEXER Operations- und Präparierscheren	217,224
LANDOLD Skalpellgriffe für Mikroklingen	199	MAYO-NOBLE Operations- und Präparierscheren	217
LANE chirurgische Pinzetten	247	MAYO-ROBSON Darmklemmen	35
LANE Tuchklemmen	298	MAYO-RUSSIAN chirurgische Pinzette	247
LANGENBECK Nadelhalter PROMEDUR	355	MAYO-STILLE Operations- und Präparierscheren	216
LANG-STEVENSON Darmklemme	33	McGIVNEY Haemorrhoidal Ligatoren	65,69
Laserchirurgie - Vaginalspekula	111,112,113,114	McGIVNEY Haemorrhoidal Faszange	70
LATERAL-Retraktor	127	McINDOE anatomische Pinzette	236
		McINDOE chirurgische Pinzetten PROMED	254
		McLEAN Geburtszange	183
		McLEAN-LUIKART Geburtszange	183
		McLEAN-TUCKER Geburtszange	183

	Seite		Seite
Medizinbecher	394	NAUNTON-MORGAN Nadelhalter PROMEDUR	357
Medizinlöffel	394	NEIVERT Nadelhalter	359
Medizinschale	394	NEIVERT Nadelhalter PROMEDUR	353
MEEKER Arterienklemme	285	NELATON Hohlsonde	366
MENGHINI Leberpunktionskanülen	87	NELSON chirurgische Pinzetten	246
Messbecher	392	NELSON Trokare	371
Metalletui für Hegar Uterus Dilatatoren	128	Nierenfasszange	90
Metallkatheter für Frauen und Männer	102	Nierenklemmen	88
Metall-Maßstäbe	19	Nierenschalen	393
METZENBAUM Nadelhalter	360	Nierensteinzangen	89
METZENBAUM Operations- und Präparierscheren	219,219,221,222,226	NISSEN Arterienklemme	278
METZENBAUM-BABY Präparierscheren	218	NONSTICK-BIPOLAR Pinzetten	257
METZENBAUM-FINO Operations- und Präparierscheren	220,227	Noppenmatten, Silikon	387
MICRO-DEBAKEY Bulldogklemmen	272	NOTO Uterus-Polypenzange	143,190
MICRO-MOSQUITO Arterienklemmen	274	NOVAK Biopsieküretten	163
MICRO-VASCULAR Nadelhalter, Titanium	353	NOVA-PRESAMETER Blutdruckmesser	9,195
MIDDELDORF Wundhaken	310	NUSSBAUM Darmklemmen	36
MIKRO-ADSON anatomische Pinzetten	235		
MIKRO-ADSON chirurgische Pinzetten	241	O	
Mikro-Biopsiestanze für Gynäkologie	161	OCHSNER Trokare	371
MIKRO-DEBAKEY atraumatische Pinzetten	251	OCULUS Lupenbrille	13
MIKRO-HARTMANN Arterienklemmen	273	OEHLER chirurgische Pinzetten PROMEDUR	255
MIKRO-JACOBSON Arterienklemmen	274	Öffnungszange für Infusionsflaschen	375
Mikro-Nadelhalter	346-353	Öhrronden	365
Mikroscheren für Gynäkologie	209-213	OLLIER Wundhaken	308
Mikro-Skalpellklingen	199	OLVECRONA Arterienklemmen	281
MIKULICZ Leberhaken	85	OMBREDANNE Darmfassklemmen	29
MIKULICZ Peritoneumklemmen	146	OMBREDANNE Tuchklemme	297
MIKULICZ-BABY Peritoneumklemme	146	Operations- und Präparierscheren	216-221
MILLER Rektumschere	58	Operations- und Präparierscheren PROMEDUR	222,225-227
MILLIN Blasenhalsspreizer	96,100	Operationsbestecke für GEBURTSHILFE	176
MILLIN Blasen spreizer	100	Operationsbestecke für GYNÄKOLOGIE	106
MILLIN Fadenzange	95	Operationsbestecke für LEBER, GALLE, NIERE	74
MILLIN Fasszange	95	Operationsbestecke für MAGEN, DARM, MASTDARM	26
MILLIN Kapsel fasszangen	95	Operationsbestecke für UROLOGIE	94
MILLS Gallengangs chere	84	O'SULLIVAN-O'CONNOR Bauchdeckenhalter	334
Mini-Container	382	OVERHOLT-BABY Arterienklemme	283
MINI-GELPI Wundsperrerr	322	OVERHOLT-GEISSENDÖRFER Arterienklemmen	283
MINI-GEMINI Arterienklemme	284	OVERHOLT-MIXTER Arterienklemme	283
MINIMUS Blutdruckmesser	10,196		
Mischschalen	393	P	
MIXTER Arterienklemmen	286	Papierfilter für Container	386
MIXTER Gallensteinzange	82	Parametriumscheren	60,225
MIXTER-BABY Arterienklemmen	285	PARKS Analspreizer verwendbar mit Kaltlicht	50
MOD. MÜNCHEN Biopsieküretten	163	PAYR Darmquetschklemmen	44
MOGEN Beschneidungsgerät	103	PAYR-BABY Darmquetschklemme	44
MOORE Gallensteinlöffel	77	PEAN Arterienklemmen	279
MORGAN Proktoskope	53	PEAN-FINO Arterienklemmen	280
MORRIS Wundhaken	307,312	PEDERSON Vaginalsepekula	114
MORRIS-MITRAL Gefäßswund spreizer	323	PEDERSON Vaginalsepekula, blendfrei für Laserchirurgie	114
MOSQUITO Arterienklemmen für Linkshänder	274	PEDERSON Vaginalsepekula, isoliert für HF-Chirurgie	114
MOSQUITO-MICRO Arterienklemme	274	PEDERSON Vaginalsepekulum für Kinder	107,114
MOYNIHAN Gallenkanalklemme	79	PEERS Tuchklemme für Papiertücher	297
MOYNIHAN Gallensteinsonde	75	PELKMANN Kornzangen	302
MOYNIHAN Tuchklemme	298	Pelvishaken	62
MÜNCHENER Model Biopsieküretten	163	Penisklemmen	103
MURLESS Kopfhebel	181	PENNINGTON Arterienklemmen	27
MUSEUX Hakenzangen	139	Perinealspreizer	52
Myomheber	145	Peritoneumklemmen	146-148
Myommesser	145	PESTALOZZA Abortuskürette	189
Myrtenblattsonden	366	Petrischale	392
		Pflegeöl für Instrumente	391
N		PHANEUF Peritoneumklemmen	148
Nabelschnurklemmen	185	PINARD Stethoskope	12,198
Nabelschnurscheren	179	Pinzetten	235-266
Nadeldosen	391,392	PIPER Geburtszangen	182,184
NAEGELE (DeLee) Geburtszange	181	PITTSBURG Lebertransplantationsklemmen	86
NAEGELE Geburtszange	181	POOLE Saugkanülen	368,370
NAEGELE Perforator	186	POST-MORTEM-Skalpellklinge	203
NAGEL Mikroscheren mit Profilgriff	213	POTTS-DE-MARTEL Gallengangscheren	84
Nagelfeilen	23	POTTS-SMITH chirurgische Pinzetten	245
Nagelhautscheren	22	POTTS-SMITH chirurgische Pinzetten PROMED	253
Nagelzangen	22	POTTS-SMITH Gallengangs chere PROMEDUR	84
Naht	343-361	POZZI Hakenzangen	134

	Seite		Seite
Präparier- und Arterienklemmen	273-293	Schlauchklemmen	299
Präparierscheren mit Profilgrif	211,216-222	Schlauchklemmen mit Schutzbügel	299
PRATT (Billroth)Hakenzange	137	Schlauchroller	299
PRATT Cystikus-Haken	63	SCHROEDER Hakenzange	134,136
PRATT Hakenzange	137	SCHROEDER Uteruslöffel	164
PRATT Mastdarmspekulum	49	SCHUBERT Biopsiezangen	156
PRATT-"T" Arterienklemme	32	SCHULTZE Salpingograph	171
PRECISA Blutdruckmesser	9,195	SCHULZE-BERGMANN Mastdarm-Spekula	48
PRESBYTERIAN Schlauchklemmen	299	SCHUMACHER Biopsiezangen	160
Proktoskope, Anuskope, Rektuskope	54-57	SCHUMACHER Nabelschnurschere	179
PRO-MEDSEKUR™ Skalpellgriffe	201	SCHUMACHER-VAN DOREN Biopsiezange	155
PROMEDUR Nadelhalter	353-358	Schwammzangen	300-304
PROMEDUR Scheren	222,224-227	Schwesterngarnitur	23
Prostatahaken	98	SCUDDER Darmklemmen	35
Prostataklemme	95	SCUDDER-DEBAKEY Darmklemmen	41
PROVIDENCE-HOSPITAL Arterienklemmen	275	SEGOND Hysterektomieklammer	149
Pylorusspreizer	45	SEGOND Myommesser	145
		SEGOND-LANDAU Hysterektomieklammer	149
R		Sekretlöffel, Urologie	103
RAMATHIBODI Tubushaken	132	SELLHEIM Geburtsloeffel	184
RAMATHIBODI Uterusmanipulator	132	SEMKEN anatomische Pinzetten	236
RAMPLEY Schwammzangen	301	SEMKEN anatomische Pinzetten PROMEDUR	253
RAMSEY anatomische Pinzette	238	SEMKEN chirurgische Pinzetten	242
RAMSEY chirurgische Pinzetten	245	SEMM Bauchdeckenhalter	333
RANDALL Biopsiekürette	163	SEMM Vaginalspekula	115
RANDALL Nierensteinzangen	89	SEYFFERT Vaginalspekula	115
RANKIN-CRILE Arterienklemmen	276	Sicherheitsdeckel für Sterilisiercontainer	376,378,380
RANKIN-KELLY Arterienklemmen	276	Sicherungsplomben, Plastik	385
RECAMIER (BUMM) Uterusküretten	168,169	Siebkörbe	377,379,381,383
RECAMIER Uterusküretten	167	Siebkörbe für Endoskopie-Instrumente	384
Rektalspreizer	50,51	SIEBOLD gynäkologische Schere	179
Rektum-Biopsiezangen	71	Silikon Fixierstreifen	388
Rektumscheren	58,59,60,223,225	Silikon Noppenmatten	387
Rektuskope, Anuskope, Proktoskope	54-57	SIMON Fistelhaken	144
RESANO atraumatische Darmklemme	40	SIMON Scheidenhalter	125
RICARD Bauchdeckenhalter	326	SIMON Uteruslöffeln	164
RICHARDSON Wundhaken	310	SIMPSON Geburtszange	181
RICHARDSON-EASTMAN Wundhaken	310	SIMPSON-BRAUN Geburtszange	182
Ringgriffe für Biopsie-Aufsätze	159	SIMPSON-LUIKART Geburtszange	182
ROBERTS Arterienklemmen	280	SIMS gynäkologische Scheren	178
ROBIN-MASSE Bauchdeckenhalter	327	SIMS Mastdarmspekulum	48
ROCHARD Bauchdeckenhaken	335	SIMS Operations- und Präparierscheren	224
ROCHARD Bauchdeckenhalter	335	SIMS Scheidenspekula	123
ROCHESTER-CARMALT Arterienklemmen	279	SIMS Uterusdepressoren	131
ROCHESTER-OCHSNER Arterienklemmen	282,290	SIMS Uterusküretten	166
ROCHESTER-PEAN Arterienklemmen	280,288	SIMS Uterussonden	130
ROEDER Tuchklemmen	298	SIMS-MAIER Polypenzangen	302
ROGGE Sterilisierzange	374	SINGLEY (TUTTLE) Fasspinzetten	240,247
Rotoklette	162	Sinus Renalis Haken	91,92
RUDD Haemmoridalligator	65	Skalpellgriffe	201-203,204-205
RUDD Ligatur-Gummiringe	65	Skalpellgriffe für Mikroklingen	199
RUMEL Arterienklemmen	284	Skalpellschlingen	199,200, 203
RUSSIAN chirurgische Pinzetten	247	SKENE Hakenzange	136
RUSSIAN Fasspinzette	239	SMELLIE Geburtshaken	185
		SMELLIE Perforator	186
S		SOFIELD Wundhaken	307
SAENGER Abortuszangen	191	SOMER Uterusfasszange	140
SAMENSTRANG-Fixierklemme	96	Sonden, Sasugrohre, Trokare	363-371
Samenstranghäkchen	99	Sortiermagazin für Kennzeichnungsschilder	385
SANTULLI Bulldogklemme	271	Spannrahmen für Sterilisiercontainer	377,379,381
SAROT Arterienklemme f. bariatrische Chirurgie	289	SPENCER-WELLS Arterienklemmen	279
SAROT Nadelhalter	361	Sphinkteroskope	52
SAROT Nadelhalter PROMEDUR	357	Spülschalen	393
SAUERBRUCH Abfallzange	374	St.MARKS Pelvishaken	62
SAUERBRUCH Nadeldose	392	St.MARKS Perinealspreizer	51
Saugrohre	367-370	St.MARKS Proktoskop	52
SCHAEDEL Tuchklemme	297	STAUDE-MOORE Hakenzange	133
Scheidenhalter	108-125	STEINER-AUVARD Vaginalspekulum	116
Scheidenhalter für Kinder	108,118	STELZNER Rektumscheren	59,223
SCHERBAK Vaginalspekula	117	Sterilisation	373-395
Scheren	207-232	Sterilisierbehälter	376,378,380,382,384,390
Scheren für Gynäkologie, Geburtshilfe	178-180	Sterilisierbehälter - Zubehör	377,379,381,383
Scheren-Klemmen, bipolar	231	Sterilisiercontainer für Endoskopie	384
SCHIMMELBUSCH Sterilisiertrommeln	390	Sterilisiercontainer für Mikroinstrumente	390
		Sterilisierklammern	375

	Seite		Seite
Sterilisierpinzetten	374	Uterusküretten	164-170
Sterisierrahmen für Mikro-Instrumente	389	Uteruslöffel	164-170
Sterilisiertrommeln	390	Uterusmanipulator	132
Sterilisiertücher	387	Uteruspolypenzange	83,142-144,190
Sterilisierzangen	374	Uterussonden	130
STILLE anatomische Pinzetten	237		
STILLE Nierenstielklemme	88	V	
STILLE-BARRAYA chirurgische Pinzetten	248	Vaginalsepekula	107-127
Stirnlampen	14,15	Vaginalsepekula für Kinder	107-109,118
Stirnlampen mit Halogen-Beleuchtung	15	Vaginalsepekula, blendfrei für Laserchirurgie	111,112,113,114
Stirnspiegel	14	Vaginalsepekula, isoliert für HF-Chirurgie	111,112,113,114
STOCKMANN Penisklemme	103	Vaginoskop mit Kaltlichtanschluss für Kinder	109,173
STONE chirurgische Pinzette	246	VALLEIX Uterussonde	130
STRATTE Nadelhalter	361	VAN BUREN Dilatationsbougies	104
STRATTE Nadelhalter PROMEDUR	357	VAN DOREN Biopsiezange	155
STRAUSS Kaltlicht-Rektoskop	57	VANNAS Mikroscheren für Gynäkologie	209,212
STRAUSS Penisklemme	103	Vasektomie-Instrumente	99
STRINGER Instrumentenbügel	375	Vasektomie-Klemmen	99
		Vergleichsinstrumente	17-20
		Vorbereitung	21-24
T			
Tamponadenführer	131	W	
TARNIER Basiotrib	186	WALDMANN Episiotomiescheren	180
TARNIER Geburtszange	183	WALLICH Abortuslöffel	189
TAYLOR chirurgische Pinzetten	245	WALTON Schwammzangen	302
TAYLOR-CUSHING chirurgische Pinzetten	245	WANGENSTEEN Fassspinzette	247
TEALE Hakenzangen	138	WANGENSTEEN Fassspinzette PROMEDUR	253
Teiler für Container	377,379,381	WANGENSTEEN Nadelhalter	361
Textilfilter für Container	387	WANGENSTEEN Nadelhalter PROMEDUR	356
Textilfilter für Container	387	WASSMUND Wundhaken	308
THOMAS Uterusküretten	165	Watteabfallbehälter	391
THOMS-ALLIS Gewebefaßklemme	28	Wattespender	391
THOMS-GAYLOR Biopsiezange	155	Watteträger für Rektoskop	64
THOMSON-WALKER Blasenhalsspreizer	101	WAUGH chirurgische Pinzetten	248
THOREK Präperierscheren	218	WEISSBARTH Scheidenspekulum	118
TIEMANN Kugelzange	136	WERTHEIM chirurgische Scheren	218
TISCHLER (Baggish)Biopsiezange	158	WERTHEIM Hysterektomieklappen	149,152
TISCHLER Biopsiezange	158	WERTHEIM Peritoneumklemme	146
TISCHLER-BURKE Biopsiezange	158	WERTHEIM-ATRAUMA Hysterektomieklappe	151
TISCHLER-KEVORKIAN Biopsiezange	158	WERTHEIM-CULLEN Hysterektomieklappe	151
TISCHLER-MINI Biopsiezange	158	WERTHEIM-DEBAKEY Hysterektomieklappen	153
TITANIUM Microvascular Nadelhalter	353	WIJNEN Saugkanüle	368,370
TOHOKU Tuchklemmen	298	WIKSTROEM Arterienklemmen	285
TOWNSEND Biopsiekürette	162	WILLET Kopfschwanzzange	187
TOWNSEND Griff für Biopsie-Aufsätze	159	WILLIAMS Gewebefaßklemmen	29
TOWNSEND-BURKE Biopsiezange	159	Winkelbleche für Sterilisiercontainer	389
TOWNSEND-KERVORKIAN Biopsiezange	159	WINTER Abortuszangen	191
TOWNSEND-KRAUSE Biopsiezange	159	WITTNER Biopsiezangen	160
TOWNSEND-MINI Biopsiezangen	159	WRIGLEY Geburtszange	181
TOWNSEND-TISCHLER Biopsiezangen	159	Wundhaken	61,62,305-317
Transformator für Stirnlampen	14	Wundspreizer	319-323
TRELAT Vaginalsepekula	115		
Trennbleche für Sterilisiercontainer	389	Y	
TREVES chirurgische Pinzetten	246	YANKAUER Saugkanülen	367
Trokare	371	YEOMAN Biopsiezangen	71
Tuben für Amnioskopie	172	YOUNG Prostatahaken	98
Tubus-Haken	132	YOUNG Prostataklammer	95
Tuch- und Schlauchklemmen, Tupferzangen	295-299		
TUEBINGEN Wundhaken (Scheidenhalter)	313	Z	
TUFFIER Arterienklemme	27	Zangenbehälter	394
Tupferzangen	300-304	Z-HYSTEREKTOMIE atraumatische Klemmen	154
TURNBULL Nagelzangen	22	ZIEGLER Stirnspiegel	14
TURNER-WARWICK Bauchdeckenhalter	338-340		
U			
ULRICH Tupferzangen	303		
UNIVERSAL Trokare	371		
Ureterklemmen	96		
Ureterzangen	90		
Urologie	93-104		
USA-MODEL Schlauchklemmen	299		
Uterusbiopsiezangen	156-161		
Uterusdepressoren	131		
Uterusdilatoren	128,129		
Uterusfasszangen	140,141		

ALPHABETICAL INDEX

A

Abdominal Retractors	324-341
Abdominal Speculum	336
Abortion Scoops	189
ADAIR Tenaculum Forceps	134
Adapter for Fiber optic light handle	55
ADLERKREUTZ Tissue Forceps	246
ADSON Dressing Forceps	235,236
ADSON Dressing Forceps PROMEDUR	253
ADSON Hemostatic Forceps	277
ADSON Needleholder	360
ADSON Tissue Forceps	241,242
ADSON Tissue Forceps PROMEDUR	253
ADSON-BABY Hemostatic Forceps	277
ADSON-BROWN Tissue Forceps	246
ADSON-BROWN Tissue Forceps PROMEDUR	255
ADSON-DEBAKEY Tissue Forceps	235
ADSON-GRAEFE Tissue Forceps	242
ADSON-MICRO Dressing Forceps	235
ADSON-MICRO Tissue Forceps	241
ADSON-SELECT Tissue Forceps	241
ALAN-PARKS Rectal Spreader	50
ALEXANDER Uterine Biopsy Forceps	157
ALLEN Intestinal Forceps	27
ALLIS atraumatic Tissue Forceps	28
ALLIS Tissue Forceps	27
ALLIS Tissue Forceps for Bariatric Surgery	27,292
ALLIS-ADAIR Tissue Forceps	28
ALLIS-BABY Tissue Forceps	27
AMANN Uterine Gauze Packer	131
Amnioscopes for micro blood extraction	172
Anaesthesia Needle & Guide	188
Anal Retractor	51
Anastomosis Clamps	46
ANDREW-PYNCHON Suction Tube	367
Angiotribes	43
Anuscopes	52,53
Aspirating Curettes, uterine	170
AUVARD Vaginal Specula	116

B

BABCOCK Tissue Forceps	29,293
BABCOCK Tissue Forceps PROMEDUR	30
BABCOCK-DEBAKEY atraumatic Tissue Forceps	30
BABY-ADSON Hemostatic Forceps	277
BABY-ALLIS Tissue Forceps	27
BABY-BALFOUR Abdominal Retractor	328
BABY-COLLIN Abdominal Retractor	324
BABY-CRILE Hemostatic Forceps	275
BABY-CRILE-WOOD Needleholder PROMEDUR	353
BABY-GELPI Retractor	322
BABY-KOCHER Intestinal Forceps	33
BABY-LEXER Dissecting Scissors	218
BABY-METZENBAUM Dissecting Scissors	218
BABY-MIKULICZ Peritoneum Clamp	146
BABY-MIXTER Hemostatic Forceps	285
BABY-OVERHOLT Hemostatic Forceps	283
BABY-PAYR Crushing Clamps	44
BACKHAUS Towel Forceps	297
BAINBRIDGE Hemostatic Forceps	279
BAKES Gall Duct Probes	76
BALFOUR Abdominal Retractors	328-330
BALFOUR-BABY Abdominal Retractor	328
BALFOUR-Modif. Abdominal Retractors	330
BALL and SOCKET Towel Forceps	298
BALLENGER Sponge Forceps	300
BARNES-NEVILLE Obstetrical Forceps	184
BARR Anal Retractor	51
BARRET Tenaculum Forceps	133
BARRON Scalpel Handle	203
BARRON Haemorrhoidal Seizing Forceps	70
BARRON Haemorrhoidal Suction Ligator	68

BARTON Obstetrical Forceps	183
BARTON Traction Handle	183
Basiotribe	186
Battery handle for Anuscopes	55
BEACHAM Amniotome	131
BENGOLEA Hemostatic Forceps	278
BENSAUDE Anuscopes	53
BENSON Pylorus Spreader	45
BERGER Uterine Biopsy Forceps	161
BERGMANN-FOERSTER Sponge Forceps	300
BERKELEY-BONNEY Hysterectomy Forceps	150
BERNHARD Towel Forceps	298
BILL Traction Handle	184
Binocular Loupe	13
Biopsy Curettes	162
Biopsy Forceps, rectal	71
Biopsy Forceps, uterine	156-161
Biopsy Needles	87
Bipolar "NONSTICK" Forceps	257-260
Bipolar Clamp-Scissors	231
Bipolar Coagulating Forceps	261-265
Bipolar Scissors	228-230
BIPOL-Cables for "BiTech" Scissors	232
BIPOL-Cables for Bipol-Forceps	266
BiTech Bipolar Scissors	228-230
Bladder Neck Instruments	97
Bladder Retractors	100-101
Blades, Scalpel	199,200,203
BLAKE Gall Stone Forceps	81
BLAKE Uterine Curette	164
BLANK atraumatic Dressing Forceps	237
BLESSING Rectal Scissors PROMEDUR	60,225
BLOND Anuscopes	56
BLOND Proctoscope-tubes	56
BODENHAMMER Rectal Speculum	49
BOERMA Obstetrical Forceps	181
BONNEY Dressing Forceps	238
BONNEY Dressing Forceps PROMEDUR	254
BONNEY Tissue Forceps	246
BONNEY Tissue Forceps PROMEDUR	255
Bowls, round	393
Bowls, solution	393
BOYNTON Needleholder	345
BOYS-ALLIS Tissue Forceps	28
BOZEMANN Needleholders	360
BOZEMANN Needleholders PROMEDUR	355
BOZEMANN Sponge- and Dressing Forceps	304
BOZEMANN Uterine Scissors	179
BOZEMANN-DOUGLAS Dressing Forceps	304
BRAUN Cranioclast	186
BRAUN Obstetrical Hook	186
BRAUN Tenaculum Forceps	133
BRAUN Uterine Depressor	131
BRAUN-STADLER Episiotomy Scissors	180
BREISKY Vaginal Retractors	124
BRIDGE Hemostatic Forceps	279
BROMPTON Drainage Clamp	299
BROPHY Dressing Forceps	237
BROPHY Tissue Forceps	244
BROWN Tissue Forceps	247
Brush Dispensers	23
Brushes, Nail	23
BRYANT Sponge- and Dressing Forceps	302
BUIE Angiotribe	43
BUIE Fistula Probe	63
BUIE Rectal Suction Tube	64
Bulldog Clamps	269-272
BUMM Uterine Curettes	168-169
BUMM Uterine Polypus and Ovum Forceps	143,190
BUNT Sterilizing Clips	375
BUSCH Umbilical Scissors	179

C

Cables for "BiTech" bipolar Scissors	232
Cables for Bipol-Forceps	266

	Page		Page
Caesarean Section Hemostatic Forceps	187	CUSCO Vaginal Specula	111
CARREL Hemostatic Forceps	273	CUSCO Vaginal Specula BLACK, for LASER Surgery	111
CASTROVIEJO Needleholders	345	CUSCO Vaginal Specula INSULATED, for HF-Surgery	111
CASTROVIEJO Needleholders PROMEDUR	345	CUSCO Vaginal Specula with centerscrew	110
Catheter Guides	102	CUSCO Vaginal Speculum for virgins	107
CHAPUT Intestinal Forceps	27	CUSHING Dressing Forceps PROMEDUR	253
CHARNLEY Abdominal Retractor	341	CUSHING Retractor	317
CHEATLE Sterilizing Forceps	374	Cuticle Scissors	22
CHERON Sponge- and Dressing Forceps	304	CUZZI Abortion Scoops	189
Circumcision Instrument	103	CZERNY Rectal Valve	47
Clampholders	46	CZERNY Retractor	307
Clamps, Bulldog	269-272	CZERNY Tumor Forceps	133
Clamps, Fixation for Drapes	388		
Clamps, Liver Transplant	86	D	
Clamps, Peritoneum	146-148	DARLING Retractors	321
Clamps, Pressure	148	DARTIGUES Uterine Elevating Forceps	90,141
Clamps, Tube-Drainage	299	DAVIS Sterilizing Forceps	374
Clamps, Tubing	299	DE LEE Obstetrical Forceps	182
Clamps, Ureter	96	DE LEE Pelvimeter	177
Clamps, Vasectomy	99	DEAVER Retractors	314-316,317
Clamp-Scissors, bipolar	231	DEBAKEY Bulldog Clamps	272
CLAR Head Mirror	14	DEBAKEY Gall Duct Scissors PROMEDUR	84
CLAR Headmirror FIBER OPTIC	15	DEBAKEY Needleholders PROMEDUR	354
Cloth Fixing Frames	377,379,381,383	DEBAKEY non-traumatic Dressing Forceps	250-252
Coagulating Forceps, bipolar	257-265	DEBAKEY non-traumatic Dressing Forceps, TITANIUM	250-252
Cold Light Projector	15,57	DEBAKEY Retractors	321
Cold Light Vaginoscope	109,173	DEBAKEY Suction Tubes	368
Coldlight-Clip for Proctoscopes, Vaginoscopes	54,173	DEBAKEY Tissue & Organ Grasping Forceps	32,83
COLLER-CRILE Hemostatic Forceps	276,286	DEBAKEY Vascular Forceps	240,250-252
COLLIN Abdominal Retractors	324	DEBAKEY Vascular Forceps PROMEDUR	254
COLLIN Dynamometer	19	DEBAKEY-ADSON Tissue Forceps	235
COLLIN Intestinal Forceps	31	DEBAKEY-BABCOCK atraum. Tissue Forceps	30
COLLIN Pelvimeter	20,177	DEBAKEY-DOYEN Intestinal Clamps	37
COLLIN Polypus Forceps	304	DEBAKEY-FEHLAND Intestinal Clamp	39
COLLIN Scalpel Handles	202,204	DEBAKEY-HAYES Intestinal Clamps	39
COLLIN Umbilical Cord Clamp	185	DEBAKEY-KOCHER Intestinal Clamps	38
COLLIN Uterine Elevating Forceps	140	DEBAKEY-MICRO Bulldog Clamps	272
COLLIN Vaginal Specula	112	DEBAKEY-MICRO Dressing Forceps	251
COLLIN Vaginal Specula BLACK, for LASER Surgery	112	DEBAKEY-SCUDDER Intestinal Clamps	41
COLLIN Vaginal Specula INSULATED, for HF-Surgery	112	DEMARTELL Scissors	84
COLLIN Vaginal Speculum for children	107	DEMARTEL-WOLFSON Anastomosis Clamps	46
COLLIN-BABY Abdominal Retractor	324	DEMARTEL-WOLFSON Applying Forceps	46
COLLIN-DUVAL Grasping Forceps	249	DEMARTEL-WOLFSON Clampholders	46
COLLIN-LOCKTITE Abdominal Retractor	325	DENIS-BROWN Abdominal Retractor for Adults	331
COLLYER Pelvimeter	20,177	DENIS-BROWN Abdominal Retractor for Children	331
Connecting Cables for "BiTech" bipolar Scissors	232	DENIS-BROWN Grasping Forceps	249
Connecting Cables for Bipol-Forceps	266	DESJARDINS Gall Duct Forceps	79
Containers, sterilizing	376,378,380,382,384,390	DESJARDINS Gall Stone Forceps	81
COOLEY non-traumatic Dressing Forceps	251	DESJARDINS Gall Stone Sounds	75
COOLEY non-traumatic Dressing Forceps TITANIUM	251	Deviders for Containers	377,379,381
COOLEY Suction Tubes	369,370	DEWEY Axis Traction Forceps	183
CORONARY Micro-Scissors	210	Diagnostics	7-15, 195-198
Cotton Carrier for Rectoscopes	64	DICK Atrauma Pressure Clamps	148
Cotton Dispensers	391	DIETRICH Bulldog Clamps	271
Cotton Waste Collectors	391	Dilators, uterine	128,129
COUPLAND Suction Tube	367	Dispenser for Identification Labels	385
CRAFOORD Dissecting- and Ligature Forceps	281	Dispensers, Cotton	391
CRAFOORD Dissecting Scissors	221	Dissecting- and Ligature Forceps	277-286
CRAFOORD-SELLORS Dissecting- and Ligature Forceps	281,289	Dissecting Scissors	216-222,226-227
Cranioclast	186	Dividers for containers	389
CRILE Hemostatic Forceps	275	DQUAY Uterine Biopsy Forceps	157
CRILE Needleholder	359	DOYEN Abdominal Retractors	336
CRILE-BABY Hemostatic Forceps	275	DOYEN Director	366
CRILE-COLLER Hemostatic Forceps	276	DOYEN Gynecological Scissors	179
CRILE-MURRAY Needleholder	359	DOYEN Intestinal Forceps	33
CRILE-RANKIN Hemostatic Forceps	276	DOYEN Myoma Screw	145
CRILE-WOOD Needleholders	359	DOYEN Polypus Forceps	82
CRILE-WOOD Needleholders for LEFT HANDER	353	DOYEN Retractor	312
CRILE-WOOD Needleholders PROMEDUR	353	DOYEN Uterine Polypus Forceps	142
CRILE-WOOD-BABY Needleholder PROMEDUR	353	DOYEN Vaginal Retractors	125
Crushing Clamps	44	DOYEN-DEBAKEY Intestinal Clamps	37
Crypt Hooks	63	DOYEN-STILLE Retractors	312
Curettes, Biopsy	162	Drapes Fixation Clamps	388
Curettes, uterine	165-169	Drapes, sterilizing	387
Curettes, uterine aspirating	170	Dressing Forceps	235-237,239,250-255

	Page		Page
Dressing Forceps PROMEDUR	253	Forceps, NONSTICK bipolar	257-260
Dressing Forceps USA-MODEL	237	Forceps, Obstetrical	181-184
Drums, sterilizing	390	Forceps, Ovum	191
DUBOIS Kephaltomy Scissors	180,186	Forceps, Polypus	303,304
DUEHRSEN Dressing Forceps	238	Forceps, Prostatic	95
DUEHRSEN Tissue Forceps	245	Forceps, Scalp flap	187
DUNHILL Hemostatic Forceps	275	Forceps, Sponge	300-304
DUPLAY Polypus Forceps	303	Forceps, sterilizing	374
DUPLAY Tenaculum Forceps	135	Forceps, Tenaculum	133-139
DUPLEX Stethoscopes	12,198	Forceps, Tissue	239-248
DURANTE Tissue Forceps	248	Forceps, Towel	297-298
DUVAL atraumatic Intestinal Forceps	31	Forceps, Tumor	137
DUVAL Grasping Forceps	249	Forceps, Ureter	90
DUVAL Intestinal Forceps	31	Forceps, Uterine Biopsy	156-161
E		Forceps, Uterine Elevating	140,141
EASTMAN Vaginal Retractors	123	Forceps, Uterine Polypus	142,143
ELLIOT Obstetrical Forceps	182	Forceps, Vulsellum	137,138,139
EMMET Fistula Hooks	144	Forceps, Waste	374
EMMET Sponge- and Dressing Forceps	303	FORD-DIXON Haemorrhoidal Ligator	66
Endospecula	127	Foreign Body Forceps, G.U.	103
Enterotomy Scissors	58	FRANKLIN-SILVERMAN Biopsy Needles	87
Episiotomy Scissors	180	FRITSCH Retractors	313
EPPENDORF Uterine Biopsy Forceps	160	FUCHSIG Hemostatic Forceps	278
EWALD Dressing Forceps	235	G	
EWALD Tissue Forceps	241	Gall Bladder Forceps	83,300
EXACTA Sphygmomanometer	10,196	Gall Duct Forceps	79-80
F		Gall Duct Probes	76
FANSLER-IVES Anoscope	53	Gall Duct Scissors	84
FANSLER-IVES Anoscope w. Cold-light attachment	54	Gall Stone Forceps	80,81-82
FAURE Peritoneum Clamps	147	Gall Stone Probes and -sounds	75,76
FAURE Uterine Biopsy Forceps	156	Gall Stone Scoops	77,78
FEHLAND-DEBAKEY Intestinal Clamp	39	Gall, Liver, Kidney	73-92
FERGUSON Gynecological Scissors	179	GAUSS Scalp Flap Forceps	187
FERGUSON Angiotribe	43	GELPI Retractors	322,323
FERRIS-SMITH Tissue Forceps	244	GELPI-BABY Retractor	322
Fiber Optic light handle for Anoscopes	55	GELPI-MINI Retractor	322
Fibre Optic Light attachment for Specula	50,53,109	GELPI-ORTHO Retractor	323
Fibre Optic Rectal Spreader	50	GELPI-SELETZ Retractor	323
FILTER Dispenser	386	GEMINI Dissecting- and Ligature Forceps	284
FILTER Holder	386	GEMINI Hemostats	293,291
FILTERS, paper	386	GEMINI-MINI Dissecting- and Ligature Forceps	284
FILTERS, textile	387	General Instruments	193-372
Fine Scissors	214	Genito-Urinary Instruments	102,103
Fine Scissors for LEFT HAND	214	GERALD Dressing Forceps PROMEDUR	254
FINOCHIETTO Needleholders	360	GERALD Tissue Forceps	244
FINOCHIETTO Needleholders PROMEDUR	355	GILLIES Tissue Forceps	242
Fistula Hooks	144	GILLIES Tissue Forceps PROMEDUR	254
Fistula Probe	63	GIL-VERNET Vein- and Hilar Retractors	91,92
Fistula Sounds	63,366	GLASSMANN non-traumatic Forceps	252
Fixation Clamps for Drapes	388	GLOVER Bulldog Clamps	269
Fixing bolts for Dividers	389	GOELET Retractor	307
Fixing bolts for instruments	389	GOODELL Uterine Dilator	129
FLETCHER (Javerts) Sponge Forceps	301	GOSSET Abdominal Retractors	327
FLETCHER Sponge Forceps	301	GOURDET Uterine Scoops	165
FOCUS Halogen-Headlight	15	Grasping Forceps	249
FOERSTER Abdominal Retractor X-ray transparent	337	GRAVE Vaginal Specula	113,115
FOERSTER Gall Bladder Forceps	83,300	GRAVE Vaginal Specula BLACK, for LASER Surgery	113
FOERSTER Sponge Forceps	293,300	GRAVE Vaginal Specula INSULATED, for HF-Surgery	113
FOERSTER-BERGMANN Sponge Forceps	300	GRAY Gall Duct Forceps	80
FOERSTER-Delicate Sponge Forceps	301	GREEN Retractor	310
Forceps	233-266	GREEN-ARMYTAGE Caesarean Section Forceps	187
Forceps Holders	375	GREGORY Bulldog Clamps	270
Forceps, bipolar	261-265	GREGORY Needleholders	349,351
Forceps, bottle-opening	375	Grooved Directors	366
Forceps, Caesarean Section hemostatic	187	GROSS Polypus Forceps	303
Forceps, Dissecting- and Ligature	277-286	GROSS Sponge- and Dressing Forceps	303
Forceps, Dressing	235-237,239,250-255	GUNNAR-HEY Tube-Drainage Clamp	299
Forceps, Gall Duct	79-80	GUTTMAN Secretion Scoop	103
Forceps, Gall Stone	80,81-82	GUYON Catheter Guides	102
Forceps, Hysterectomy	150-154	GUYON Kidney Pedicle Forceps	88,291,293
Forceps, Kidney	88-90	GUYON Urethral Bougies, Sounds	104
Forceps, Membrane puncture	188	GWILLIAM Hysterectomy Forceps	150
		Gynecological Scissors	178-180

	Page		Page
Gynecology	105-174	JACOBSON-MICRO Hemostatic Forceps	274
		JARCHO Tenaculum Forceps	134
H		Jars	394
Haemorrhoidal Ligators	65-69	JEFFERSON Dressing Forceps	236
Haemorrhoidal Seizing Forceps	70	JEFFERSON Tissue Forceps	242
Haemorrhoidal Suction Ligators	66-68	JOERGENSEN Dissecting Scissors	217
Halogen Cold Light Projector	15,57	JOHN-HOPKINS Gall Duct Forceps	80
Halogen-Headlights	15	JOHNSON Needleholder	360
HALSTED Hemostatic Forceps	277	JOLL (Friedmann) Vaginal Retractor	126,321
HALSTED-MOSQUITO Hemostatic Forceps	274	JONES Towel Forceps	297
Handles for anoscopes	55	JUDD-ALLIS Tissue Forceps	28
Handles for Uterine Biopsy Forceps	159	JUDD-MASON Bladder Retractors	100,101
Handles, Scalpel	199,201-205	K	
HARRINGTON Bronchus Forceps	292	KALLMORGEN Specula, Retractors	122
HARRISON Sterilizing Forceps	374	KANE Umbilical Cord Clamp	185
HARTMANN Hemostatic Forceps	273	KANTROWITZ Dissecting- and Ligature Forceps	284
HARTMANN Ligature-Forceps	273	KELLY Hemostatic Forceps	275
HARTMANN-MICRO Hemostatic Forceps	273	KELLY Ovum Forceps	191
HAYES-DEBAKEY Intestinal Clamps	39	KELLY Proctoscopes	52
Head Mirrors	14	KELLY Retractors	85,311
Headlights (halogen)	15	KELLY Sphincteroscope	52
HEANEY (Hegar) Needleholder	361	KELLY-RANKIN Hemostatic Forceps	276
HEANEY Hysterectomy Forceps	149	Kephalotomy Scissors	180,186
HEANEY Needleholders PROMEDUR	356	KERSTING Intestinal Clamp	40
HEANEY-BALLENTINE Hysterectomy Forceps	149	KEVORKIAN Biopsy Curettes	162
HEANEY-KANTER Hysterectomy Forceps	149	KEVORKIAN Uterine Biopsy Forceps	161
HEANEY-REZEK Hysterectomy Forceps	149	KEVORKIAN-PACIFIC Uterine Biopsy Forceps	158
HEGAR Uterine Dilators	128	Kidney Bowls	393
HEISS Hemostatic Forceps	278	Kidney Forceps	88-90
Hemostatic- and Dissecting Forceps	267-293	Kidney Stone Forceps	89
HENROTIN Vulsellum Forceps	137	KIELLAND Obstetrical Forceps	181
HERRICK Kidney Pedicle Forceps	88	KIELLAND-LUIKART Obstetrical Forceps	182
HERTZLER Abdominal Retractor	328	KIRSCHNER Abdominal Retractor	332
HEYWOOD-SMITH Haemorrhoidal Forceps	70	KLEINSCHMIDT Appendectomy Clamp	45
HEYWOOD-SMITH Uterine Polypus Forceps	83,142,190	KLING-EX Blade Remover	205
HILL-FERGUSON Rectal Valves	47	KLINIK.BERLIN Tubing Clamp	299
HIRSCHMANN Anoscopes	52	KOCHER Intestinal Forceps	34
HOESEL Retractors	61	KOCHER Prostatic Retractor	97
HOLZBACH Abdominal Retractor	326	KOCHER-BABY Intestinal Forceps	33
Hooklets, Fistula	144	KOCHER-DEBAKEY Intestinal Clamps	38
Hooklets, Spermatic Cord	99	KOCHER-WAGNER Retractors	313
HORGAN Center valve	330	KOERTE Retractors	308
HRYNTSCHAK Bladder Retractor	101	KOGAN Endospecula	127
HULKA Tenaculum Forceps	135	KONRICH Sterilizing Drums	390
HULKA-KENWICK Tenaculum Forceps	135	KRISTELLER Vaginal Retractors for virgins	108
Hysterectomy Forceps	150-154	KRISTELLER Vaginal Specula for virgins	108
I		KRISTELLER Vaginal Specula, Retractors	118-121,126
Identification Labels for Containers	385	KRISTELLER Vaginal Specula, Retractors for children	118
Infusion-Bottle Opening Forceps	375	KÜSTNER Vulsellum Forceps	139
Instrument depositing Trays	394	L	
Instrument Lubricant	391	LAHEY Gall Duct Forceps	79
Instrument Pads	387	LAHEY Retractor	309
Instrument Sets for GALL, LIVER, KIDNEY	74	LANDAU Vaginal Retractors	124
Instrument Sets FOR GYNECOLOGY	106	LANDOLD Scalpel Handles	199
Instrument Sets for OBSTETRICS	176	LANE Tissue Forceps	247
Instrument Sets for STOMACH, INTESTINES, RECTUM	26	LANE Towel Forceps	298
Instrument Sets for UROLOGY	94	LANGENBECK Needleholders PROMEDUR	355
Instrument Trays	395	LANG-STEVENSON Intestinal Clamp	33
Insufflation-bottle opening Forceps	375	LATERAL Vaginal Retractor	127
Intestinal Forceps	27	LAWRENCE Dissecting- and Ligature Forceps	285
IOWA Membrane Puncture Forceps	188	LEFT-HANDER Needleholders	353,354
IOWA Pudendus Anesthesia Needle & guide	188	LEFT-HANDER Scissors	215,216
IOWA Trumpet Needle Guide	188	LEGUEU Bladder Retractor	325
ISRAEL Retractors	309	LEGUEU Bladder Spatula	97
IUD Extractor hook	132	LERCHE Tissue Forceps	246
IUD Manipulator & Sponge Forceps	132	LEXER-BABY Dissecting Scissors	218
J		LICHTENBERG Needleholder PROMEDUR	358
JACKSON Vaginal Retractors	123	LICHTWITZ Trocar	371
JACKSON-BURROWS Retractor	323	LISTER-SINUS Dressing Forceps	302
JACOBS Vulsellum Forceps	138	LITTAUER Nail Splitting Forceps	22
		LITTLE Retractor	309
		LITTLEWOOD Tissue Forceps	28

	Page		Page
Liver Biopsy Needles	87	Micro Scalpel Blades	199
Liver Retractors	85	Micro Scissors for Gynecology	209-213
Liver-Transplant Clamp	86	Micro Uterine Biopsy Punch	161
LLOYD-DAVIS Rectal Scissors	59,223	MICRO-ADSON Dressing Forceps	235
LLOYD-DAVIS Sigmoid Anastomosis Forceps	43	MICRO-ADSON Tissue Forceps	241
LOCKHART-MUMMERY Fistula Sounds	63,366	MICRO-DEBAKEY Bulldog Clamps	272
LOCKWOOD Tissue Forceps	29	MICRO-DEBAKEY Dressing Forceps	251
LORNA (Edna) Towel Forceps	298	MICRO-DEBAKEY Dressing Forceps TITANIUM	251
Loupe, operating	13	Micro-Dissecting Scissors	212
LOWER Gall Duct Forceps	80	MICRO-HARTMANN Hemostatic Forceps	273
LUER-KOERTE Gall Stone Scoops	78	MICRO-JACOBSON Hemostatic Forceps	274
LUIKART Obstetrical Forceps	182	MICRO-MOSQUITO Hemostatic Forceps	274
LUIKART-BILL Traction Handle	184	Micro-Needleholders	345-353
LURZ Haemorrhoidal Suction Ligators	66	MICRO-VASCULAR Needleholders TITANIUM	353
LURZ Ureter Clamps	96	MIDDELDORF Retractors	310
		MIKULICZ Peritoneum Clamps	146
		MIKULICZ Retractors	85
M		MIKULICZ-BABY Peritoneum Clamp	146
MAIER Polypus Forceps	303	MILLER Rectal Scissors	58
MAIER Sponge- and Dressing Forceps	303	MILLIN Bladder Neck Spreader	96,100
MAINGOT Hysterectomy Forceps	150	MILLIN Bladder Retractor	100
Manipulator & Sponge Forceps, IUD	132	MILLIN Prostatic Forceps	95
Manometers, bloodpressure	11,197	MILLS Gall Duct Scissors	84
MARBERGER Vein- and Hilar Retractors	91	MINIMUS Sphygmomanometer	10,196
MARINUS Intestinal Clamps	42	Mirros- head	14
MARTEL Scalp Flap Forceps	187	MIXTER Dissecting- and Ligature Forceps	286
MARTIN Pelvimeter	20,177	MIXTER Gall Stone Forceps	80,82
MARTIN Uterine Sounds	130	MIXTER-BABY Hemostatic Forceps	285
MARTIN Waste Forceps	374	MIXTER-O'SHAUGHNESSY Hemostatic Forceps	283
MASSON Needleholder	361	MOGEN Circumcision Instrument	103
MASSON Needleholder PROMEDUR	356	MOORE Gall Stone Scoop	77
MATHIEU Foreign Body Forceps	103	MORGAN Proctoscopes	53
MATHIEU Needleholders PROMEDUR	358	MORRIS Retractors	307,312
MATHIEU Rectal Speculum	49	MORRIS-MITRAL Retractor	323
MATHIEU-KOCHER Needleholders PROMEDUR	358	MOSQUITO Hemostatic Forceps	274
MAYO Dissecting Scissors	216	MOSQUITO-MICRO Hemostatic Forceps	274
MAYO Dissecting Scissors PROMEDUR	222	MOYNIHAN Clamp-Forceps	79
MAYO Gall Stone Scoops	77	MOYNIHAN Gall Stone Probe	75
MAYO Safety Pins	375	MOYNIHAN Towel Forceps	298
MAYO Scissors for LEFT-HANDERS	216	MUENCHEN Endometrial Biopsy Curettes	163
MAYO Sterilizing Clips	375	MURLESS Head Extractor	181
MAYO-ADAMS Abdominal Retractor	325	MUSEUX Vulsellum Forceps	139
MAYO-BLAKE Gall Stone Forceps	82	Myoma Instruments	145
MAYO-GUYON Kidney Forceps	88	MYRTLE LEAF Probes	366
MAYO-HARRINGTON Dissecting Scissors	217		
MAYO-HARRINGTON Dissecting Scissors PROMEDUR	224	N	
MAYO-HEGAR Needleholders	359	NAEGELE (DELEE) Obstetrical Forceps	181
MAYO-HEGAR Needleholders for LEFT-HANDERS	354	NAEGELE Perforator	186
MAYO-HEGAR Needleholders PROMEDUR	354	NAGEL Micro-Scissors	213
MAYO-LEXER Dissecting Scissors	217	Nail files	23
MAYO-LEXER Dissecting Scissors PROMEDUR	224	Nail Nippers	22
MAYO-NOBLE Dissecting Scissors	217	Nail Scissors	22,23
MAYO-ROBSON Intestinal Forceps	35	Nail Splitting Forceps	22
MAYO-RUSSIAN Tissue Forceps	247	Nailbrush autoclavable	23
MAYO-STILLE Dissecting Scissors	216	NAUNTON-MORGAN Needleholder PROMEDUR	357
McGIVNEY Haemorrhoidal Ligator	65	Needle Cases	391,392
McGIVNEY Haemorrhoidal Seizing Forceps	70	Needle Guide	188
McGIVNEY Haemorrhoidal Suction Ligator	69	Needleholders for LEFT-HANDERS	353,354
McINDOE Dressing Forceps	236	Needleholders, Micro	345-353
McINDOE Dressing Forceps PROMEDUR	254	Needleholders, Micro, PROMEDUR	345,347-349,353-358
McLEAN-LUIKART Obstetrical Forceps	183	Needleholders, Micro, TITANIUM	350,351,352,353
McLEAN-TUCKER Obstetrical Forceps	183	Needles, Liver Biopsy	87
Measures, graduated	392	NEIVERT Needleholder	359
Meatus Clamps	103	NEIVERT Needleholder PROMEDUR	353
Medicine Cups	394	NELATON Probe-Director	366
Medicine Spoon	394	NELSON Abdominal Trocars	371
MEEKER Dissecting- and Ligature Forceps	285	NELSON Tissue Forceps	246
MENGHINI Liver Biopsy Needles	87	NISSEN Hemostatic Forceps	278
Metal Catheters, male, female	102	NONSTICK Bipolar Forceps	257-260
METZENBAUM Dissecting Scissors	219,221	NOTO Uterine Polypus Forceps	143,190
METZENBAUM Dissecting Scissors PROMEDUR	222,226,227	NOVAK Endometrial Biopsy Curettes	163
METZENBAUM Needleholder	360	NOVA-PRESAMETER Manometer	9,195
METZENBAUM-BABY Dissecting Scissors	218	NUSSBAUM Intestinal Forceps	36
METZENBAUM-FINO Dissecting Scissors	220		
METZENBAUM-FINO Dissecting Scissors PROMEDUR	227		

	Page		Page
O			
Obstetrical Forceps	181-184	PRO-MED SEKUR™ Scalpel Handles	201
Obstetrical Hook	184,185	Prostatic Retractors	97,98
Obstetrical Lever	184	PROVIDENCE-HOSPITAL Hemostatic Forceps	275
Obstetrics	175-191	Pylorus Spreader	45
OCHSNER Trocars	371	R	
OCULUS Binocular Loupe	13	RAMATHIBODI Tubular Hook	132
OEHLER Tissue Forceps PROMEDUR	255	RAMATHIBODI Uterine Manipulator	132
OLLIER Retractors	308	RAMPLEY Sponge Forceps	301
OLVECRONA Dissecting- and Ligature Forceps	281	RAMSAY Dressing Forceps	238
OMBREDANNE Tissue Forceps	29	RAMSAY Tissue Forceps	245
OMBREDANNE Towel Forceps	297	RANDALL Endometrial Biopsy Curette	163
Operating Loupe	13	RANDALL Kidney Stone Forceps	89
Operating Scissors	215	RANKIN-CRILE Hemostatic Forceps	276
Operating Sets for GALL, LIVER, KIDNEY	74	RANKIN-KELLY Hemostatic Forceps	276
Operating Sets FOR GYNECOLOGY	106	RECAMIER Uterine Curettes	167
Operating Sets for OBSTETRICS	176	Rectal Biopsy Forceps	71
Operating Sets for STOMACH, INTESTINES, RECTUM	26	Rectal Retractors	61,62
Operating Sets for UROLOGY	94	Rectal Scissors	58-60,223
O'SULLIVAN-O'CONNOR Abdominal Retractor	334	Rectal Specula	48,49
OVERHOLT-BABY Hemostatic Forceps	283	Rectal Spreaders	50,51
OVERHOLT-GEISSENDOERFER Hemostatic Forceps	283	Rectal Suction Tube	64
OVERHOLT-MIXTER Hemostatic Forceps	283	Rectal Valves	47
Ovum Forceps	191	Remover for Scalpel blades	205
P			
PARAMETRIUM Scissors	60,225	RESANO Intestinal Clamp	40
PARKS Rectal Spreader with fibre optic	50	Retractors, abdominal	324-341
PAYR Crushing Clamps	44	Retractors, Bladder	100-101
PAYR-BABY Crushing Clamps	44	Retractors, double-ended	307,310
PEAN Hemostatic Forceps	279	Retractors, Hand	305-317
PEAN-FINO Hemostatic Forceps	280	Retractors, Liver	85
PEDERSON Speculum für virgins	107,114	Retractors, Pelvis	62
PEDERSON Vaginal Specula	114	Retractors, prostatic	97,98
PEDERSON Vaginal Specula BLACK, for LASER Surgery	114	Retractors, Rectum	61,62
PEDERSON Vaginal Specula INSULATED, for HF-Surgery	114	Retractors, self-retaining	321-323
PEERS Towel Forceps	297	Retractors, vaginal	108,118-126
PELKMANN Sponge- and Dressing Forceps	302	Retractors, Vein and Hilar	91
Pelvimeters	20,177	RICARD Abdominal Retractors	326
Pelvis Retractors	62	RICHARDSON Retractors	310
PENNINGTON Hemostatic Forceps	27	RICHARDSON-EASTMAN Retractors	310
Perforator, obstetrical	186	ROBERTS Hemostatic Forceps	280
Perineal Retractor	51	ROBIN-MASSE Abdominal Retractor	327
Peritoneum Clamps	146-148	ROCHARD Abdominal Retractors	335
PESTALOZZA Abortion Scoop	189	ROCHARD Fixation Device	335
PETRI Dish	392	ROCHARD Mounting Frames	335
PHANEUF Peritoneum Clamps	148	ROCHESTER-OCHSNER Hemostatic Forceps	279,282,290
PINARD Stethoscopes	12,198	ROCHESTER-PEAN Hemostatic Forceps	280,288
PIPER Axis Traction Forceps	184	ROEDER Towel Forceps	298
PIPER Obstetrical Forceps	182	ROGGE Sterilizing Forceps	374
PITTSBURG Liver Transplant Clamps	86	ROTOCLETTE Uterine Biopsy Curette	162
Polypus Forceps	303,304	Round Bowls	393
POOLE Suction Tubes	368,370	RUDD Haemorrhoidal Ligator	65
POTTS-DE-MARTEL Gall Duct Scissors	84	RUDD Ligature Rubber Rings	65
POTTS-SMITH Dressing Forceps	238	Rulers, metal	19
POTTS-SMITH Dressing Forceps PROMEDUR	253	RUMEL Hemostatic Forceps	284
POTTS-SMITH Gall Duct Scissors PROMEDUR	84	RUSSIAN Tissue Forceps	239,247
POTTS-SMITH Tissue Forceps	245	S	
POZZI Tenaculum Forceps	134	SAENGER Ovum Forceps	191
PRATT (Billroth) Tumor Forceps	137	Safety Lids for Sterilizing Containers	376,378,380
PRATT Crypt Hooks	63	Safety Pins for instruments	375
PRATT Rectal Speculum	49	Safety Seals, plastic	385
PRATT Tumor Forceps	137	Salpingograph, SCHULTZE	171
PRATT-"T" Hemostatic Forceps	32	SANTULLI Bulldog Clamp	271
PRECISA Sphygmomanometer	9,195	SAROT Dissecting- and Ligature Forceps	289
PRESBYTERIAN Tubing Clamp	299	SAROT Needleholders	361
Pressure Clamps	148	SAROT Needleholders PROMEDUR	357
Probes	365	SAUERBRUCH Needle Case	392
Probes with eye	365	SAUERBRUCH Waste Forceps	374
Probes, double ended	365	Scalp Flap Forceps	187
Probes, exploring	365	Scalpel Blade Remover	205
Probes, grooved	366	Scalpel Blades	199,200,204
Proctoscopes	52	Scalpel Blades, Micro	199
Proctoscope-tubes	56	Scalpel Handles	199,201-205
		Scalpel Handles for Micro Blades	199

	Page		Page
Scalpel Handles PRO-MED SEKUR™	201	SPENCER-WELLS Hemostatic Forceps	279
Scalpel Handles, calibrated	202,204	Spermatic Cord Fixation Clamp	96
SCHAEDEL Towel Clip	297	Spermatic Cord Hooklets	99
SCHERBAK Vaginal Specula	117	Sphygmometers, bloodpressure	11,197
SCHIMMELBUSCH Sterilizing Drums	390	Spiral Supports Micro Instruments	388
SCHROEDER Tenaculum Forceps	134	Sponge Forceps	300-304
SCHROEDER Uterine Scoops	164	St.MARKS Pelvis Retractors	62
SCHROEDER Vulsellum Forceps	136	St.MARKS Perineal Retractor	51
SCHUBERT Uterine Biopsy Forceps	156	ST.MARKS Proctoscope	52
SCHULTZE Salpingograph	171	STAUDE-MOORE Tenaculum Forceps	133
SCHULZE-BERGMANN Rectal Specula	48	STEINER-AUVARD Vaginal Speculum	116
SCHUMACHER Umbilical Scissors	179	STELZNER Rectal Scissors	59,223
SCHUMACHER Uterine Biopsy Forceps	160	Sterilization	373-395
SCHUMACHER-VAN DOREN Biopsy Forceps	155	Sterilizing Containers	376,378,380,382,384,390
Scissors	207-232	Sterilizing Containers for Endoscopy Instruments	384
Scissors, bipolar	228-230	Sterilizing Containers, FLAT	382
Scissors, Cuticle	22	Sterilizing Containers, MINI	382
Scissors, delicate	214	Sterilizing Drapes	387
Scissors, dissecting	216	Sterilizing Drums	390
Scissors, Enterotomy	58	Sterilizing Forceps	374
Scissors, Episiotomy	180	Sterilizing Forceps with jar	393
Scissors, Gall Duct	84	Sterilizing Rack for Micro-Instruments	389
Scissors, Gynecology	178-180	Stethoscope	12,198
Scissors, Kephilotomy	180,186	STILLE Dressing Forceps	237
Scissors, Micro	209-213	STILLE Kidney Pedicle Forceps	88
Scissors, Nail	22	STILLE-BARRAYA Tissue Forceps	248
Scissors, Operating	215	STINGER Forceps Holders	375
Scissors, Parametrium	60,225	STOCKMANN Meatus Clamp	103
Scissors, Rectal	58-60,223	Stomach, Intestines, Rectum	25-71
Scissors, Umbilical	179	STONE Tissue Forceps	246
Scissors, unterming	179	Storage Strips, Silicone	388
Scissors-Clamp, bipolar	231	STRATTE Needleholder	361
Scoops, Uterine	164,165	STRATTE Needleholders PROMEDUR	357
SCUDDER Intestinal Forceps	35	STRAUSS Fiber optic Rectoscope	57
SCUDDER-DEBAKEY Intestinal Clamps	41	STRAUSS Meatus Clamp	103
Secretion Scoop	103	STRINGER Forceps Holders	375
SEGOND Hysterectomy Hysterectomy Forceps	149	Suction Tubes	367-390
SEGOND Myoma Knife	145	Suggested Instrument Sets for GALL, LIVER, KIDNEY	74
SEGOND-LANDAU Hysterectomy Forceps	149	Suggested Instrument Sets for GYNECOLOGY	106
Self-retaining Retractors	321-323	Suggested Instrument Sets for OBSTETRICS	176
SELLHEIM Obstetrical Lever	184	Suggested Instrument Sets for STOMACH, INTESTINES, RECTUM	26
SEMKEN Dressing Forceps	236	Suggested Instrument Sets for UROLOGY	94
SEMKEN Dressing Forceps PROMEDUR	253	Supports for Micro Instruments	388
SEMKEN Tissue Forceps	242	Suture	343-361
SEMM Abdominal Retractor	333		
SEMM Vaginal Specula	115	T	
SEYFFERT Vaginal Specula	115	Tablet Dishes	394
SIEBOLD Gynecological Scissors	179	Tape Measures	19
Silicone Instrument Pads	387	TARNIER Basiotribe	186
Silicone Storage Strips	388	TARNIER Obstetrical Forceps	183
SIMON Fistula Hooks	144	TAYLOR Tissue Forceps	245
SIMON Uterine Scoops	164	TAYLOR-CUSHING Tissue Forceps	245
SIMON Vaginal Retractors	125	TEALE Vulsellum Forceps	138
SIMPSON Obstetrical Forceps	181	Teneculum Forceps	133-139
SIMPSON-BRAUN Obstetrical Forceps	182	THOMAS Uterine Curettes	165
SIMPSON-LUIKART Obstetrical Forceps	182	THOMS-ALLIS Tissue Forceps	28
SIMS Gynecological Scissors	178	THOMS-GAYLOR Biopsy Forceps	155
SIMS Gynecological Scissors PROMEDUR	224	THOMSON-WALKER Bladder Retractor	101
SIMS Rectal Speculum	48	THOREK Dissecting Scissors	218
SIMS Uterine Curettes	166	TIEMANN Bullet Forceps	136
SIMS Uterine Depressor	131	TISCHLER (Baggish) Uterine Biopsy Forceps	158
SIMS Uterine Sounds	130	TISCHLER Uterine Biopsy Forceps	158
SIMS Vaginal Specula	123	TISCHLER-BURKE Uterine Biopsy Forceps	158
SIMS-MAIER Sponge- and Dressing Forceps	302	TISCHLER-KEVORKIAN Uterine Biopsy Forceps	158
SINGLEY (TUTTLE) Tissue Forceps	240,247	TISCHLER-MINI Uterine Biopsy Forceps	158
SKENE Tenaculum Forceps	136	Tissue- and Organ holding Forceps	27-32
SMELLIE Obstetrical Hook	185	Tissue Forceps	239-248
SMELLIE Perforator	186	Tissue Forceps USA Model	243
SOFIELD Retractors	307	TITANIUM-COOLEY non-traumatic Dressing Forceps	251
Solution Bowls	393	TITANIUM-DEBAKEY non-traumatic Dressing Forceps	250-252
SOMER Uterine Elevating Forceps	140	TOHOKU Towel Forceps	298
Sounds, Fistula	63,366	Towel Forceps	297-298
Sounds, uterine	130	TOWNSEND Handle for Uterine Biopsy Forceps	159
Specula, vaginal	107-127	TOWNSEND Uterine Biopsy Curette	162
Speculum, abdominal	337	TOWNSEND-BURKE Uterine Biopsy Forceps	159

	Page		Page
TOWNSEND-KERVORKIAN Uterine Biopsy Forceps	159	WERTHEIM-CULLEN Hysterectomy Forceps	151
TOWNSEND-KRAUSE Uterine Biopsy Forceps	159	WERTHEIM-DEBAKEY Hysterectomy Forceps	153
TOWNSEND-MINI Uterine Biopsy Forceps	159	WIJNEN Suction Tube	368,370
TOWNSEND-TISCHLER Uterine Biopsy Forceps	159	WIKSTROEM Dissecting- and Ligature Forceps	285
Traction Handles, obstetrical	183,184	WILLET Scalp Flap Forceps	187
Transformer for Head Mirror	14	WILLIAMS Tissue Forceps	29
Trays, Instrument	395	WINTER Ovum Forceps	191
Trays, kidney-shaped	393	Wire baskets	377,379,381,383,384
TRELAT Vaginal Specula	115	Wire baskets for Endoscopy Instruments	384
TREVES Tissue Forceps	246	WITTNER Uterine Biopsy Forceps	160
Trocars, abdominal	371	WRIGLEY Obstetrical Forceps	181
Tube-Drainage Clamps	299		
Tubes, Suction	367-390	Y	
Tubing Clamps	299	YANKAUER Suction Tubes	367
Tubing Clamps with safeguard	299	YEOMAN Rectal Biopsy Forceps	71
TUEBINGEN Retractor	313	YOUNG Prostatic Grasping Forceps	95
TUFFIER Intestinal Forceps	27	YOUNG Prostatic Retractors	98
Tumor Forceps	137		
TURNBULL Nail Nippers	22	Z	
TURNER-WARWICK Abdominal Retractor	338-340	Z-HYSTEREKTOMY Forceps	154
		ZIEGLER Head Mirror	14
U			
ULRICH Sponge- and Dressing Forceps	303		
Umbilical Cord Clamp	185		
Umbilical Scissors	179		
UNIVERSAL Abdominal Trocars	371		
Utermine Scissors	179		
Ureter Clamp	96		
Ureter Forceps	90		
Urethral Bougies, Sounds	104		
URO Ureter Forceps	90		
Urology	93-104		
USA-MODEL Tubing Clamps	299		
Uterine aspirating Curettes	170		
Uterine Biopsy Curettes	162		
Uterine Biopsy Forceps	156-161		
Uterine Curettes	165-169		
Uterine Depressors	131		
Uterine Dilators	128,129		
Uterine Elevating Forceps	140,141		
Uterine Manipulator	132		
Uterine Polypus Forceps	142,143		
Uterine Scoops	164,165		
Uterine Sounds	130		
V			
Vaginal Retractors	108,118-126		
Vaginal Specula	107-127		
Vaginoscope, Cold light	109,173		
VALLEIX Uterine Sound	130		
VAN BUREN Urethral Bougies, Sounds	104		
VAN DOREN Biopsy Forceps	155		
VANNAS-MICRO Scissors	209,212		
Vasectomy Instruments	99		
Vein- and Hilar Retractors	91,92		
Velcro-cuffs for manometers, sphygmometers	11,197		
Vulsellum Forceps	137,138,139		
W			
WALDMANN Episiotomy Scissors	180		
WALLICH Abortion Scoop	189		
WALTON Sponge- and Dressing Forceps	302		
WANGENSTEEN Dressing Forceps PROMEDUR	253		
WANGENSTEEN Needleholder	361		
WANGENSTEEN Needleholder PROMEDUR	356		
WANGENSTEEN Tissue Forceps	247		
WASSMUND Retractor	308		
Waste Collectors, Cotton	391		
Waste Forceps	374		
WAUGH Tissue Forceps	248		
WEISSBARTH Vaginal Speculum	118		
WERTHEIM Dissecting Scissors	218		
WERTHEIM Hysterectomy Forceps	146,149,152		
WERTHEIM-ATRAUMA Hysterectomy Forceps	151		

INDEX ALPHABETIQUE**A**

Abdominal Spéculum	336
Accouchement	175-191
ADAIR Pince utérine	133-138
ADLERKREUTZ Pincés à griffes	246
ADSON Pincés à disséquer	235,236
ADSON Pincés à disséquer et à ligatures	277
ADSON Pincés à disséquer PROMEDUR	253
ADSON Pincés à griffes	241,242
ADSON Pincés à griffes PROMEDUR	253
ADSON Porte-aiguilles	360
ADSON-BABY Pincés à disséquer et à ligatures	277
ADSON-BROWN Pince à disséquer PROMEDUR	255
ADSON-BROWN Pincés à griffes	246
ADSON-DEBAKEY Pince à griffes	235
ADSON-DEBAKEY Pince atraumatique	235
ADSON-GRAEFE Pince à griffes	242
ADSON-MICRO Pince à griffes	241
ADSON-MICRO Pincés à disséquer	235
ADSON-SELECT MICRO Pince à sutures	241
ADSON-SELECT Pince à griffes	241
Aiguilles pour biopsie du foie	87
Aiguilles pour ponction du foie	87
ALAN-PARKS Ecarteurs rectaux	50
ALEXANDER Pince à biopsie utérine	157
ALLEN-KOCHER Pincés intestinales	27
ALLIS Pincés intestinales	27
ALLIS Pincés intestinales atraumatique	28
ALLIS-ADAIR Pince intestinale	28
ALLIS-BABY Pince intestinale	27
AMANN Porte-coton	131
Amnioscopie, instruments	172
Amniotome	131
ANDREW-PYNCHON Tube d'aspiration	367
Anneaux en caoutchouc pour ligateurs	65
Anusscopes	52,53,54,56
Appendectomie, Clamps	45
Aspiration	367-370
Attache de fixation pour les instruments	389
Attache de fixation pour séparateurs	389
AUVARD Spéculum vaginaux	116

B

BABCOCK Pincés intestinales	29
BABCOCK Pincés intestinales PROMEDUR	30
BABCOCK-DEBAKEY Pincés intestinales atraumatique	30
BABY-ADSON Pincés à disséquer et à ligatures	277
BABY-ALLIS Pince intestinale	27
BABY-BALFOUR Ecarteur abdominal	328
BABY-COLLIN Ecarteur abdominal	324
BABY-CRILE Pincés hémostatiques	275
BABY-CRILE-WOOD s PROMEDUR	353
BABY-GELPI Ecarteur	322
BABY-KOCHER Pincés intestinales	33
BABY-LEXER Ciseaux à préparation	218
BABY-METZENBAUM Ciseaux à préparation	218
BABY-MIKULICZ Pince à péritoine	146
BABY-MIXTER Pincés hémostatiques	285
BABY-OVERHOLT Pincés à préparation	283
BABY-PAYR Ecraseur	44
BACKHAUS Pincés à champs	297
BAINBRIDGE Pincés hémostatiques	279
BAKES Sondes pour le canal cholédoque	76
BALFOUR Bras latérales	330
BALFOUR Ecarteurs abdominaux	328-330
BALFOUR-BABY Ecarteur abdominal	328
BALFOUR-Modif. Ecarteurs abdominaux	330
BALL et SOCKET Pincés à champs	298
BALLENGER Pincés à pansements	300
Bande porte instruments	388
BARNES-NEVILLE Pince obstétricale	184
BARR Ecarteur rectal	51

BARRET Pince utérine	133
BARRON Ligateur pour Hémorroïdes	68
BARRON Manche pour bisturis	203
BARRON Pince à saisir	70
BARTON Pince obstétricale	183
BARTON Tacteur pour Pince obstétricale	183
Basiotribe	186
Bassins reniform	393
BEACHAM Amniotome	131
BENGOLEA Pincés à disséquer et à ligatures	278
BENSAUDE Anusscopes	53
BENSON Ecarteur du pylore	45
BERGER Pincés à biopsie utérine	161
BERGMANN-FOERSTER Pincés à pansements	300
BERKELEY-BONNEY Pincés à hystérectomie	150
BERNHARD Pince à champs	298
Bile, Foie, Rein	73-92
BILL Tacteur pour Pince obstétricale	184
Bipolaire Ciseaux	228-230
Bipolaire Clamps-Ciseaux	231
BIPOL-Cables pour Ciseaux "BiTech"	232
Bistouri à fibromes	145
BiTech Ciseaux bipolaires	228-230
BLAKE Curette utérine	164
BLAKE Pincés pour calculs biliaires	81
BLANK Pincés à disséquer atraumatique	237
BLESSING Ciseaux pour chirurgie rectale	60,225
BLOND Anusscopes	56
BLOND Tubes conique de proctoscope	56
BODENHAMMER Spéculum rectal	49
BOERMA Pince obstétricale	181
Boîtes à aiguilles	391,392
Boîtes à instruments avec couvercle	395
Boîtes à stérilisation	376,378,380,382,384,390
Boîtes à stérilisation plats	382
Boîtes opératoires proposées pour ACCOUCHEMENT	176
Boîtes opératoires proposées pour BILE, FOIE, REIN	74
Boîtes opératoires proposées pour ESTOMAC, INTESTINS, RECTUM	26
Boîtes opératoires proposées pour GYNECOLOGIE	106
Boîtes opératoires proposées pour UROLOGIE	94
BONNEY Pince à disséquer	238
BONNEY Pince à disséquer PROMEDUR	255
BONNEY Pincés à griffes	246
BONNEY Pincés à griffes PROMEDUR	254
Bougies dilatatrices pour l'urètre	104
BOYNTON s	345
BOYS-ALLIS Pince intestinale	28
BOZEMANN Ciseaux pour Gynécologie	179
BOZEMANN Pincés porte-éponges	304
BOZEMANN Porte-aiguilles PROMEDUR	355
BOZEMANN s	360
BOZEMANN-DOUGLAS Pincés porte-éponges	304
Bras latérales pour Ecarteurs Balfour	330
Brassards pour Tensiomètres	11,197
BRAUN Crochet à décapitation	186
BRAUN Depresseur utérin	131
BRAUN Perce-crâne	186
BRAUN Pince utérine	133
BRAUN-STADLER Ciseaux à épisiotomie	180
BREISKY Ecarteurs vaginaux	124
BRIDGE Pincés à disséquer et à ligatures	279
BROMPTON Pince à draire les tubes	299
BROPHY Pincés à disséquer atraumatique	237
BROPHY Pincés à griffes	244
Brosse à main autoclavable	23
Brosses, distributeurs	23
BRYANT Pince-tampons	302
BUIE Pince à pression	43
BUIE Sonde à fistules	63
BUIE Tube à aspiration rectal	64
Bulldog Clamps	269-272
BUMM Curettes malleables tranchante	168,169
BUMM Pince à polypes utérins	143,190
BUNT Epingle à instruments	375
BUSCH Ciseaux pour cordon umbilical	179

	Page		Page
C			
Cables d'alimentation pour ciseaux "BiTech"	232	CORONAIRE Ciseaux	210
Cables d'alimentation pour pinces bipolaires	266	Coupe à comprimés	394
Cadre fixe-toiles pour MINI-Container	383	Coupes	393
Cadres fixe-toiles pour Containers	377,379,381,383	COUPLAND Tube d'aspiration	367
Canal cholédoque, sondes	76	Couvercles de sécurité pour boîtes	378,378,380
Canule pour anesthésie transvaginal	188	CRAFOORD Ciseaux chirurgicaux	221
CARREL Pince hémostatique	273	CRAFOORD-SELLORS Pince hémostatique	289
Cassettes à stérilisation pour instruments délicats	390	CRAFOORD-SELLORS Pincés à dissequer et à ligatures	281
CASTROVIEJO	345	CRILE	359
CASTROVIEJO PROMEDUR	345	CRILE Pincés hémostatiques	275
Cathéters métalliques pour femmes et hommes	102	CRILE-BABY Pincés hémostatiques	275
CHAPUT Pince Intestinal	27	CRILE-MURRAY	359
CHARNLEY Ecarteur abdominal	341	CRILE-WOOD	359
CHEATLE Pincés à stérilisation	374	CRILE-WOOD PROMEDUR	353
CHERON Pince porte-éponges	304	CRILE-WOOD-BABY PROMEDUR	353
Chevalet à stérilisation pour Micro-instruments	389	Crochets à fistules	144
Chirurgie Générale	193-372	Crochets à fistules rectales	63
Circoncision, instrument	103	Crochets pour le canal spermatique	99
Ciseaux	209-232	Cuillère à médecine	394
Ciseaux & Lime à ongles & chain	23	Cuillère pour calculs biliaires	77
Ciseaux à détroncation	180,186	Curettes à aspiration	170
Ciseaux à envies	22	Curettes à biopsie utérine	162,163
Ciseaux à épisiotomie	180	Curettes à faux germes	189
Ciseaux à ongles	22	Curettes pour calculs biliaires	77,78
Ciseaux à paramétrium PROMEDUR	60,225	Curettes utérines	164-169
Ciseaux à préparation	216-227	CUSCO Spéculum vaginaux	110
Ciseaux bipolaire "BiTech"	228-230	CUSCO Spéculum vaginaux antiréfléchissant p.Chir. LASER	111
Ciseaux chirurgicaux	215	CUSCO Spéculum vaginaux isolé p. Chirurgie HF	111
Ciseaux chirurgicaux SUPERCUT	215	CUSCO Spéculum vaginaux Modèle suisse	110
Ciseaux coronaires	210,213	CUSHING Ecarteurs pour Chirurgie bariatrique	317
Ciseaux coronaires, Titanium	210	CUSHING Pincés à dissection PROMEDUR	253
Ciseaux délicats	214	Cuvettes rondes	393
Ciseaux délicats pour GAUCHERS	214	CUZZI Curettes à faux germes	189
Ciseaux délicats SUPERCUT	214	CZERNY Ecarteur double	307
Ciseaux pour Accouchement	178-180	CZERNY Pince utérine	133
Ciseaux pour chirurgie rectale	60,225	CZERNY Valve rectal	47
Ciseaux pour cordon ombilical	179	D	
Ciseaux pour entérotomie	58	D.I.U. Crochet pour extraction	132
Ciseaux pour GAUCHERS	215	D.I.U. Pincés à préhension	132
Ciseaux pour gynécologie PROMEDUR	224	DARLING Ecarteurs	321
Ciseaux pour le canal cholédoque	84	DARTIGUES Pince Hystérolabe	90,141
Ciseaux pour rectum	59,223	DAVIS Pincés à stérilisation	374
Ciseaux-Clamps bipolaires	231	DE LEE Pelvimètre	177
Clamp à Appendectomie	45	DE LEE Pince obstétricale	182
Clamps à compression	148	DEAVER Ecarteurs	313-316,317
Clamps Bulldog	269-272	DEBAKEY Ciseaux PROMEDUR	84
Clamps pour cordon ombilical	185	DEBAKEY Clamps Bulldog	272
Clamps-Ciseaux bipolaires	231	DEBAKEY Ecarteurs autostatiques	321
CLAR Miroirs frontaux	14,15	DEBAKEY Pince à griffes PROMEDUR	254
CLIP - lumière froide pour Proctoscopes	54,173	DEBAKEY Pince ovulaire	32,83
Coagulation bipolaire, pincés	256-260	DEBAKEY Pincés vasculaires atraumatiques	240,250-252
COLLER-CRILE Pincés hémostatiques	276	DEBAKEY Porte-aiguilles PROMEDUR	354
COLLIN Clamp pour cordon ombilical	185	DEBAKEY Tubes d'aspiration	368
COLLIN Compas pelvimètre	20,177	DEBAKEY-BABCOCK Pincés intestinales atraumatique	30
COLLIN Dynamomètre	19	DEBAKEY-COLLIER Pincés hémostatique	287
COLLIN Ecarteur abdominal	324	DEBAKEY-DOYEN Pincés intestinales	37
COLLIN Manches pour bistouris	202,204	DEBAKEY-FEHLAND Pince intestinale	
COLLIN Pince à polypes	304	DEBAKEY-HAYES Pincés intestinales	39
COLLIN Pince Hystérolabe	140,141	DEBAKEY-KOCHER Pincés intestinales	38
COLLIN Pince intestinale	31	DEBAKEY-MICRO Clamps Bulldog	272
COLLIN Spéculum vaginaux	112	DEBAKEY-MICRO Pincettes vasculaires	251
COLLIN Spéculum vaginaux antiréfléchissant p.Chir. LASER	112	DEBAKEY-MICRO Pincettes vasculaires TITANIUM	251
COLLIN Spéculum vaginaux isolé p. Chirurgie HF	112	DEBAKEY-SCUDDER Pincés intestinales	41
COLLIN Spéculum vaginaux pour enfants	107-109,118	DEBAKEY-WERTHEIM Pincés à hystérectomie	153
COLLIN-BABY Ecarteur abdominal	324	DEMARTELL Ciseaux	84
COLLIN-DUVAL Pincés à intestins	249	DEMARTEL-WOLFSON Pincés pour anastomoses intestinales	46
COLLIN-LOCKTITE Ecarteur abdominal	325	DENIS-BROWN Ecarteurs abdominaux	331
COLLYER Compas pelvimètre	20,177	DENIS-BROWN Pince à intestins	249
Containers pour instruments d'Endoscopie	384	Depresseurs utérins	131
COOLEY Pince vasculaires atraumatiques	251	DESJARDINS Explorateur pour calculs biliaires	75
COOLEY Pince vasculaires atraumatiques TITANIUM	251	DESJARDINS Pincés pour calculs biliaires	81
COOLEY Tubes d'aspiration	369,370	DESJARDINS Pincés pour le canal cholédoque	79
Cordons pour ciseaux bipolaires	232	DEWEY Pince obstétricale	183
Cordons pour pinces bipolaires	266	Diagnostique	195-198

	Page		Page
DICK Clamps à compression	148	FAURE Pincès à péritoine	147
DIETRICH Clamps Bulldog	271	FEHLAND-DEBAKEY Pince intestinale	39
Dilatateurs pour le canal cholédoque	76	FERGUSON Ciseaux pour Gynécologie	179
Dilatateurs utérins	128,129	FERGUSSON Pincès à pression	43
Dispositif à lumière froide Halogène	15,57	FERRIS-SMITH Pincès à griffes	244
Distributeur à filtres	386	Filtres, papier	386
Distributeurs de coton	391	Filtres, textile	387
Distributeurs pour brosses	23	FINOCHIETTO	360
DOUAY Pince à biopsie utérine	157	FINOCHIETTO Porte-aiguilles PROMEDUR	355
DOYEN Ciseaux pour Gynécologie	179	Fixe-filtres	386
DOYEN Ecarteurs abdominaux	312,336	FLETCHER (Javerts) Pince-tampons	301
DOYEN Ecarteurs vaginaux	125	FLETCHER Pincès-tampons	301
DOYEN Pince à polypes	82	FOCUS Halogène-Eclairer frontal	15
DOYEN Pincès intestinales	33	FOERSTER Ecarteur abdominal, transparent aux rayons X	337
DOYEN Sonde cannelée	366	FOERSTER Pince à éponges	293
DOYEN Tracteur pour fibromes	145	FOERSTER Pincès à pansements	300,301
DOYEN-DEBAKEY Pincès intestinales	37	FOERSTER Pincès pour la vésicule biliaire	83,300
DOYEN-STILLE Ecarteurs abdominaux	312	Fond du crible pour containers	383
Draps de stérilisation	387	FORD-DIXON Ligateur pour Hémorroïdes	66
DUBOIS Ciseaux à détroncation	180,186	FRANKLIN-SILVERMAN Aiguilles à biopsie	87
DUEHRSSSEN Pince à dissequer	238	FRIEDMANN (Joll) Ecarteur autostatique	126,321
DUEHRSSSEN Pince à griffes	245	FRITSCH Ecarteurs abdominaux	313
DUNHILL Pincès hémostatiques	275	FUCHSIG Pince à dissequer et à ligatures	278
DUPLAY Pince utérine	135		
DUPLAY Pincès à polypes	303	G	
DUPLEX Stéthoscopes	12,198	GAUCHERS, Ciseaux	214,215
DURANTE Pincès à dissequer	248	GAUCHERS, Poerte-Aiguilles	353,354
DUVAL Pince à intestins	249	GAUSS Pince pour le cuir chevelu	187
DUVAL Pince intestinale atraumatique PROMEDUR	31	GELPI Ecarteurs autostatiques	322,323
DUVAL Pincès intestinales	31	GELPI-BABY Ecarteur	322
Dynamomètre	19	GELPI-MINI Ecarteur	322
		GELPI-SELETZ Ecarteur	323
E		GEMINI Pincès à préparation	284
EASTMAN Spéculum vaginaux	123	GEMINI Pincès hémostatiques	293,291
Ecarteur à perinée	51	GEMINI-MINI Pincès à préparation	284
Ecarteur abdominal, transparent aux rayons X	337	GERALD Pincès à griffes	244
Ecarteur du pylore	45	GERALD Pincès à griffes PROMEDUR	254
Ecarteur pour le col vésical	96	GILLIES Pince à griffes	242
Ecarteur vesicale	325	GILLIES Pince à griffes PROMEDUR	254
Ecarteurs	305-317	GIL-VERNET Ecarteurs à hile renal	91,92
Ecarteurs à hile renal	91,92	GLASSMANN Pincès atraumatiques	252
Ecarteurs à prostate	97,98	GLOVER Clamps Bulldog	269
Ecarteurs abdominaux	311-313,324-341	Gobelets à médecine	394
Ecarteurs autostatiques	319-341	Gobelets gradués	392
Ecarteurs doubles	307,310,	GOELET Ecarteur double	307
Ecarteurs endo-cervicaux	127	GOODELL Dilatateur utérin	129
Ecarteurs pour Chirurgie bariatrique	321	GOSSET Ecarteurs abdominaux	327
Ecarteurs pour foie	85	GOURDET Curettes utérines	165
Ecarteurs rectaux	50-51,61,62	GRAVE Spéculum vaginaux	113,114
Ecarteurs vaginaux	124-126	GRAVE Spéculum vaginaux antiréfléchissant p.Chir. LASER	113
Ecarteurs vesicaux	101	GRAVE Spéculum vaginaux isolé p. Chirurgie HF	113
Eclairer frontal, halogène	15	GRAY Pincès pour le canal cholédoque	80
Ecraseurs pour l'intestin	44	GREEN Ecarteur	310
ELLIOT Pincès obstétricales	182	GREEN-ARMYTAGE Pincès utérines	187
Embout lumière froide pour Proctoscopes	50,53,109	GREGORY Clamps Bulldog	270
Embouts, Pincès à biopsie utérine	159	GREGORY MICRO Porte-aiguilles PROMEDUR	349
EMMET Crochets à fistules	144	GROSS Pincès à polypes	303
EMMET Pince porte-tampons	303	GUNNAR-HEY Pince draire-tubes	299
Epingles à instruments	375	GUTTMAN Cuiller à secretion	103
EPPENDORF Pince à biopsie utérine	160	GUYON Bougies dilatatrices pour l'urètre	104
Estomac, Intestins, Rectum	25-71	GUYON Mandrils pour introduire cathétères	102
Etiquettes d'identification en papier	385	GUYON Pincès rénales	88,291
Etriers pour instruments	375	GUYON Trousse à dilatation	104
EWALD Pince à dissequer	235	GWILLIAM Pincès à hystérectomie	150
EXACTA Tensiomètre	10,196	Gynécologie	105-173
Explorateurs pour calculs biliaires	75		
Extracteur-lames	205	H	
		HARRINGTON Pince hémostatique	292
F		HARRISON Pincès à stérilisation	374
FANSLER-IVES Anuscope	53	HARTMANN Pincès hémostatiques	273
FANSLER-IVES Anuscope avec lumière froide	54	HARTMANN-MICRO Pincès hémostatiques	273
FAURE Pince à biopsie utérine	156	HARTMANN-MOSQUITO Pincès hémostatiques	274
		HAYES-DEBAKEY Pincès intestinales	39
		HEANEY (Hegar)	361

	Page		Page
HEANEY Pincés à hystérectomie	149	KOERTE Ecarteurs	308
HEANEY Porte-aiguilles PROMEDUR	356	KOGAN Ecarteurs endocervicaux	127
HEANEY-BALLENTINE Pincés à hystérectomie	149	KONRICH tambours de stérilisation	390
HEANEY-KANTER Pincés à hystérectomie	149	KRISTELLER Spéculems vaginaux	108,118,119-122
HEANEY-REZEK Pincés à hystérectomie	149	KÜSTNER Pince utérine	139
HEGAR Dilatateurs utrines	128,129		
HEISS Pincés à dissequer et à ligatures	278	L	
HENROTIN Pince utérine	137	LAHEY Ecarteur	309
HERRICK Pince rénale	88	LAHEY Pincés pour le canal cholédoque	79
HERTZLER Ecarteur abdominal	328	Lames de bistouris	199,200,203
HEYWOOD-SMITH Pince à polypes	83,142,190	Lames de bistouris, Micro	199
HEYWOOD-SMITH Pince pour hémorroïdes	70	LANDAU Ecarteurs vaginaux	124
HILL-FERGUSON Valves rectales	47	LANDOLD Manches pour bisturis	199
HIRSCHMANN Anusscopes	52	LANE Pincés à champs	298
HOESEL Ecarteurs rectaux	61	LANE Pincés à griffes	247
HOLZBACH Ecarteur abdominal	326	LANGENBECK Porte-aiguilles PROMEDUR	355
HORGAN Valves pour Ecarteurs	330	LANG-STEVENSON Pince intestinal	33
HRYNTSCHAK Ecarteur vesical	101	Lateral Ecarteur vaginal	127
Huile d'entretien des instruments	391	LAWRENCE Pince à préparation	285
HULKA Pince utérine	135	LEGUEU Ecarteur à prostate	97
HULKA-KENWICK Pince utérine	135	LEGUEU Ecarteur vesicale	325
Hystéromètres	130	LERCHE Pince à griffes	246
Hystéro-Salpingographie	171	LEXER Ciseaux à préparation	217
		LEXER Ciseaux à préparation PROMEDUR	224
I		LEXER-BABY Ciseaux à préparation	218
Instrument à circoncision	103	LICHTENBERG Porte-aiguilles PROMEDUR	358
Instrumentation pour Amnioscopie et micro-prise de sang	172	LICHTWITZ Trocart	371
Instruments à comparaison	18-19	Ligateurs aspiratrices pour Hémorroïdes	66-68
IOWA Canule pour anesthésia transvaginal	188	Ligateurs pour Hémorroïdes	65-69
IOWA Pince prise membranes	188	Limes à ongles	23
IOWA trompette guide-aiguilles	188	LISTER-SINUS Pincés à tampons	302
ISRAEL Ecarteurs	309	LITTAUER Pincés à ongles	22
		LITTLE Ecarteur	309
J		LITTLEWOOD Pince intestinale	28
JACKSON Spéculems vaginaux	123	LLOYD-DAVIS Ciseaux pour rectum	59,223
JACKSON-BURROWS Ecarteur	323	LLOYD-DAVIS Pince à anastomose	43
JACOBS Pincés utérines	138	LOCKHART-MUMMERY Sondes à fistules	63,366
JACOBSON-MICRO Pincés hémostatiques	274	LOCKWOOD Pince intestinale	29
JARCHO Pince utérine	134	LORNA Pincés à champs	298
JEFFERSON Pince à dissequer	236	Loupes binoculaires	13
JEFFERSON Pince à griffes	242	LOWER Pince pour le canal cholédoque	80
JOERGENSEN Ciseaux à préparation	217	LUER-KOERTE Curettes pour calculs biliaires	78
JOHN-HOPKINS Pince pour le canal cholédoque	80	LUIKART Pince obstétricale	182
JOHNSON	360	LUIKART-BILL Tracteur pour Pince obstétricale	184
JONES Pincés à champs	297	LURZ Cône de charge	66,67,68
JUDD-ALLIS Pincés intestinales	28	LURZ Pincés à urètere	96
JUDD-MASON Ecarteurs vesicalaux	100,101		
		M	
K		Magasin à étiquettes d'identification	385
KALLMORGEN Spéculems vaginaux	122	MAIER Pincés à polypes	303
KANE Clamp à cordon umbilical	185	MAINGOT Pincés à hystérectomie	150
KANTROWITZ Pincés à préparation	284	Manche à lumière froide pour Anusscopes	55
KELLY Ecarteurs	311	Manches à piles pour anusscopes	55
KELLY Ecarteurs pour foie	85,311	Manches pour bistouris PRO-MEDSEKUR™	201
KELLY Pince à faux germe	191	Manches pour bisturis	199,201-203,204-205
KELLY Pince à polypes utérins	142,190	Manches pour Microbistouris	199
KELLY Pincés hémostatiques	275	Manches pour Pincés à biopsie utérine	159
KELLY Proctoscopes	52	Mandrils pour introduire cathéters	102
KELLY Sphincteroscopes	52	MARBERGER Ecarteurs à hile rénal	91
KERSTING Clamp Intestinal	40	MARINUS Pincés intestinales	42
KEVORKIAN Curettes à biopsie utérine	162	MARTEL Pince pour le cuir chevelu	187
KEVORKIAN Pince à biopsie utérine	161	MARTIN Compas pelvimètre	20,177
KEVORKIAN-PACIFIC Pince à biopsie	158	MARTIN Hystéromètres	130
KIELLAND Pince obstétricale	181	MARTIN Pince à déchets	374
KIELLAND-LUIKART Pince obstétricale	182	MASSON	361
KIRSCHNER Ecarteurs abdominaux	332	MASSON Porte-aiguilles PROMEDUR	356
KLEINSCHMIDT Clamp pour Appendectomie	45	MATHIEU Pince à corps étrangers	103
KLING-EX Extracteur-Lames	205	MATHIEU Porte-aiguilles PROMEDUR	358
KLINIK.BERLIN Pince presse-tube	299	MATHIEU Spéculem rectal	49
KOCHER Ecarteur à prostate	97	MATHIEU-KOCHER Porte-aiguilles PROMEDUR	358
KOCHER Pincés intestinales	34	MAYO Ciseaux à préparation	216
KOCHER-BABY Pincés intestinales	33	MAYO Ciseaux à préparation PROMEDUR	222
KOCHER-DEBAKEY Pincés intestinales	38	MAYO Curettes pour calculs biliaires	77
KOCHER-WAGNER Ecarteurs abdominaux	313	MAYO Epingles à instruments	375

	Page		Page
MAYO-ADAMS Ecarteur abdominal	325	MURLESS Elevateur à tête	181
MAYO-BLAKE Pincés pour calculs biliaires	82	MUSEUX Pincés utérines	139
MAYO-GUYON Pince rénale	88	N	
MAYO-HARRINGTON Ciseaux à préparation	217	NAEGELE Perce-crâne	186
MAYO-HARRINGTON Ciseaux pour gynécologie	224	NAEGELE Pincés obstétricales	181
MAYO-HEGAR Porte-aiguilles	359	NAGEL Micro-Ciseaux	213
MAYO-HEGAR Porte-aiguilles pour Gauchers PROMEDUR	354	NAUNTON-MORGAN Porte-aiguilles PROMEDUR	357
MAYO-HEGAR Porte-aiguilles PROMEDUR	354	NEIVERT Porte-aiguilles	359
MAYO-LEXER Ciseaux à préparation	217	NEIVERT Porte-aiguilles PROMEDUR	353
MAYO-LEXER Ciseaux à préparation PROMEDUR	224	NELATON Sonde boutonée/cannalée	366
MAYO-NOBLE Ciseaux à préparation	217	NELSON Pince pour saisir	246
MAYO-ROBSON Pincés intestinales	35	NELSON Trocarts	371
MAYO-RUSSIAN Pince à griffes	247	NISSEN Pince à dissequer et à ligatures	278
MAYO-STILLE Ciseaux à préparation	216	NONSTICK Pincés bipolaires	256-260
MAYO-STILLE Ciseaux à préparation SUPERCUT	216	NOTO Pince à polypes utérins	143,190
McGIVNEY Ligateurs pour Hémorroïdes	65,69	NOVAK Curettes à biopsie utérine	163
McGIVNEY Pincés à saisir Hémorroïdes	70	NOVA-PRESAMETER Tensiomètre	9,195
McINDOE Pince à dissequer	236	NUSSBAUM Pincés intestinales	36
McINDOE Pince à dissequer PROMEDUR	254	O	
McLEAN Pince obstétricale	183	Obstétrique	175-191
McLEAN-LUIKART Pince obstétricale	183	OCHSNER Trocarts	371
McLEAN-TUCKER Pince obstétricale	183	OCULUS Loupes binoculaires	13
MEEKER Pince à préparation	285	OEHLER Pincés à griffes PROMEDUR	255
MENGHINI Aiguilles pour biopsie du foie	87	OLLIER Ecarteurs	308
METZENBAUM	360	OLVECRONA Pincés à dissequer et à ligatures	281
METZENBAUM Ciseaux à préparation	219,221	OMBREDANNE Pince à champs	297
METZENBAUM Ciseaux à préparation PROMEDUR	222,226	OMBREDANNE Pince intestinale	29
METZENBAUM-BABY Ciseaux	218	Ongles, instruments	23
METZENBAUM-BABY Ciseaux à préparation	218	O'SULLIVAN-O'CONNOR Ecarteur abdominal	334
METZENBAUM-FINO Ciseaux à préparation	220	Ouvre-bouteilles d'infusion	375
METZENBAUM-FINO Ciseaux à préparation PROMEDUR	227	OVERHOLT-BABY Pincés à préparation	283
MICRO Porte-aiguilles	345-352,353	OVERHOLT-GEISSENDOERFER Pincés hémostatiques	283
MICRO Porte-aiguilles PROMEDUR	347-349	OVERHOLT-MIXTER Pince à préparation	283
MICRO Porte-aiguilles TITANIUM	350,351,353	P	
MICRO-ADSON Pince à griffes	241	Panier à stérilisation avec couvercle	383
MICRO-ADSON Pincés à dissequer	235	Paniers grillagés	377,379,381,383,384
Micro-Ciseaux	205-213	Paniers pour Endoscopie	384
MICRO-DEBAKEY Clamps Bulldog	272	Parametrium Ciseaux	60,225
MICRO-HARTMANN Pincés hémostatiques	273	PARKS Ecarteur rectal pour embout lumière froide	50
MICRO-JACOBSON Pincés hémostatiques	274	PAYR Ecraseurs	44
MICRO-Lames de bistouris	199	PAYR-BABY Ecraseur	44
MICRO-MOSQUITO Pincés hémostatiques	274	PEAN Pincés hémostatiques	279
MICRO-VASCULAR Porte-aiguilles	353	PEAN-FINO Pincés hémostatiques	280
MIDDELDORF Ecarteurs	310	PEDERSON Spéculums vaginaux	107,114
MIKULICZ Ecarteurs pour foie	85	PEDERSON Spéculums vaginaux antiréfléchissant p.Chir. LASER	114
MIKULICZ Pincés à péritoine	146	PEDERSON Spéculums vaginaux isolé p. Chirurgie HF	114
MIKULICZ-BABY Pince à péritoine	146	PEERS Pince à champs	297
MILLER Ciseaux pour enterotomie	58	PELKMANN Pincés à pansements	302
MILLIN Ecarteur à prostatectomie	100	Pelvimètres	20,177
MILLIN Ecarteur pour le col vésical	96,100	PENNINGTON Pincés intestinales	27
MILLIN Pince à fils	95	Perces-crâne	186
MILLIN Pincés pour saisir capsule	95	PESTALOZZA Curette à faux germes	189
MILLS Ciseaux	84	PETRI Boîte ronde	392
MINI Boîtes à stérilisation	382	PHANEUF Pincés à péritoine	148
MINI-GEMINI Pincés à préparation	284	PINARD Stéthoscopes	12,198
MINIMUS II Tensiomètre	10,196	Pince à corps étrangers	103
Miroirs frontaux	14,15	PINCE à griffes USA Model	243
MIXTER Pince pour calculs biliaires	80,81	Pince fixe-toiles	388
MIXTER Pincés hémostatiques	286	Pince Hystérolabe	90,141
MIXTER-BABY Pincés hémostatiques	285	Pince pour fixer canal déférent	96
MIXTER-O'SHAUGHNESSY Pincés à préparation	283	Pince pour Microbiopsie du col	161
MOGEN Instrument à circoncision	103	Pince pour ouvrir bouteilles d'infusion	375
MOORE Cuiller pour calculs biliaires	77	Pince pour pénis	103
MORGAN Proctoscopes	53	Pince pour saisir	247,249
MORRIS Ecarteurs abdominaux	312	Pince pour saisir la prostate	95
MORRIS Ecarteurs doubles	307	Pincés	235-266
MORRIS-MITRAL Ecarteur autostatique	323	Pincés à biopsie rectale	71
MOSQUITO Pincés hémostatiques MAIN GAUCHE	274	Pincés à biopsie utérine	155-161
MOSQUITO-MICRO Pincés hémostatiques	274	Pincés à champs	297-298
MOYNIHAN Explorateur malleable	75	Pincés à déchets	374
MOYNIHAN Pince à champs	298	Pincés à dissequer	235-239
MOYNIHAN Pincés pour le canal cholédoque	79		
MUENCHEN Curettes à biopsie utérine	163		

	Page		Page
Pincés à dissequer et à ligatures	277-286	RAMATHIBODI Manipulateur utérin	132
Pincés à dissequer PROMEDUR	253-255	RAMPLEY Pincés à pansements	301
Pincés à dissequer USA-MODEL	237	RAMSAY Pince à dissequer atraumatique	238
Pincés à draire les drains	300	RAMSAY Pincés à griffes	245
Pincés à faux germe	191	RANDALL Curettes à biopsie utérine	163
Pincés à griffes	239,241-248,253-255	RANDALL Pincés pour calculs rénales	89
Pincés à hystérectomie	146-154	RANKIN-CRILE Pincés hémostatiques	276
Pincés à intestins	249	RANKIN-KELLY Pincés hémostatiques	276
Pincés à ongles	22	RECAMIER Curettes utérines	167
Pincés à pansements	300-304	Rectoscope	57
Pincés à péritoine	146-148	Règles	19
Pincés à polypes	302,303	RESANO Clamp Intestinal	40
Pincés à polypes utérins	142,190	Ressorts spiraux pour Micro-instruments	388
Pincés à préhension D.I.U.	132	RICARD Ecarteurs abdominaux	326
Pincés à pression	43	RICHARDSON Ecarteurs	310
Pincés à saisir Hémorroïdes	70	RICHARDSON-EASTMAN Ecarteurs doubles	310
Pincés à stérilisation	374	ROBERTS Pincés hémostatiques	280
Pincés à tampons avec couvercle	393	ROBIN-MASSE Ecarteur abdominal	327
Pincés à urètre	96	ROCHARD Compas articulé	335
Pincés atraumatiques	250-252	ROCHARD Dispositifs	335
Pincés atraumatiques TITANIUM	250,251	ROCHARD Ecarteurs abdominaux	335
Pincés bipolaires "NONSTICK"	256-260	ROCHESTER-CARMALT Pincés hémostatiques	279
Pincés bipolaires à coagulation	261-265	ROCHESTER-OCHSNER Pincés hémostatiques	282,29
Pincés hémostatiques	273-276	ROCHESTER-PEAN Pincés hémostatiques	280,288
Pincés hémostatiques et à préparation	269-293	ROEDER Pincés à champs	298
Pincés hystérolabe	141	ROGGE Pincés à stérilisation	374
Pincés intestinales	27-44	ROTOCLETTE Curettes à biopsie utérine	162
Pincés intestinales atraumatique	28,29-32,37-41	Rubans métrique	19
Pincés obstétricales	181-184	RUDD Ligateur pour Hémorroïdes	65
Pincés ovulaires	32,83	RUMEL Pincés à préparation	284
Pincés pour anastomoses intestinales	46	RUSSIAN Pincés à griffes	239,247
Pincés pour calculs biliaires	80,81-82		
Pincés pour calculs rénales	89	S	
Pincés pour la vésicule biliaire	83,300	SAENGER Pincés à faux germe	191
Pincés pour le canal cholédoque	79-80	Salpingographe	171
Pincés pour le col de l'utérus	133	SANTULLI Clamp Bulldog	271
Pincés pour le cuir chevelu	187	SAROT Pince hémostatique	289
Pincés pour saisir capsule	95	SAROT Porte-aiguilles	361
Pincés pour urètre	90	SAROT Porte-aiguilles PROMEDUR	357
Pincés presse-tube	299	SAUERBRUCH Boîte à aiguilles	392
Pincés presse-tube avec protecteur	299	SAUERBRUCH Pince à déchets	374
Pincés rénales	88	Scellés de sécurité plastique	385
Pincés utérines	133-143,187	SCHAEDEL Pince à champs	297
Pincés vasculaires atraumatiques	250-252	SCHERBAK Spéculum vaginaux	117
Pincés pour transplantation du foie	86	SCHIMMELBUSCH tambours de stérilisation	390
Pincés-tampons	302	SCHROEDER Curettes utérines	164
PIPER Pincés obstétricale	182,184	SCHROEDER Pincés utérines	134,136
PITTSBURG Clamps pour transplantation fu foie	86	SCHUBERT Pincés à biopsie utérine	156
Plaquettes d'identification	385	SCHULTZE Salpingographe	171
Plateaux à instruments	395	SCHULZE-BERGMANN Spéculum rectaux	48
POOLE Tubes d'aspiration	368,37	SCHUMACHER Ciseaux pour cordon umbilical	179
Port-cotons	131	SCHUMACHER Pince à biopsie utérine	160
Porte-aiguilles	345-361	SCHUMACHER-VAN DOREN Pince à biopsie utérine	155
Porte-aiguilles pour Gauchers PROMEDUR	353,354	SCUDDER Pincés intestinales	35
Portes-coton pour rectoscopes	64	SCUDDER-DEBAKEY Pincés intestinales	41
POST-MORTEM Lames de bisturies	203	SEGOND Bistouri à fibromes	145
POTTS-DE-MARTEL Ciseaux	84	SEGOND Pincés à hystérectomie	149
POTTS-SMITH Ciseaux PROMEDUR	84	SEGOND-LANDAU Pincés à hystérectomie	149
POTTS-SMITH Pincés à dissequer	238	SELLHEIM Cuiller obstétricale	184
POTTS-SMITH Pincés à dissequer PROMEDUR	253	SEMKEN Pince à griffes PROMEDUR	253
POTTS-SMITH Pincés à griffes	245	SEMKEN Pincés à dissequer	236
Poubelles pour coton	391	SEMKEN Pincés à griffes	242,253
POZZI Pincés utérines	134	SEMM Ecarteurs abdominaux	333
PRATT Crochets fistules rectales	63	SEMM Spéculum vaginaux	115
PRATT Pincés utérines	137	Séparateurs pour boîtes à stérilisation	377,379,381,389
PRATT Spéculum rectal	49	SEYFFERT Spéculum vaginaux	115
PRATT-"T" Pince hémostatique	32	SIEBOLD Ciseaux pour Gynécologie	179
PRECISA Tensiomètre	9,195	Silicone bande porte-instruments	388
PRESBYTERIAN Pincés presse-tube	299	SIMON Crochets à fistules	144
Proctoscopes	52,56	SIMON Curettes utérines	164
PRO-MEDSEKUR™ Manches à bistouris	201	SIMON Ecarteurs vaginaux	125
PROVIDENCE-HOSPITAL Pincés hémostatiques	275	SIMPSON Pince obstétricale	181
		SIMPSON-BRAUN Pince obstétricale	182
R		SIMPSON-LUIKART Pince obstétricale	182
RAMATHIBODI Crochet tubulaire	132	SIMS Ciseaux SUPERCUT	178

	Page		Page
SIMS Ciseaux pour Accouchement	178	TOWNSEND Manche seul	159
SIMS Ciseaux pour gynécologie PROMEDUR	224	TOWNSEND-KERVORKIAN Pince à biopsie utérine	159
SIMS Curettes utérines	166	TOWNSEND-KRAUSE Pince à biopsie utérine	159
SIMS Depresseur utérin	131	TOWNSEND-MINI Pincettes à biopsie utérine	159
SIMS Hystéromètres	130	TOWNSEND-TISCHLER Pincettes à biopsie utérine	159
SIMS Spéculum rectal	48	Tracteurs pour fibromes	145
SIMS Spéculum vaginaux	123	Tracteurs pour Pince obstétricales	183,184
SIMS-MAIER Pincettes à polypes	302	Transformateur à lumière froide Halogène	15
SINGLEY (TUTTLE) Pince à saisir	240,247	Transformateur pour Miroirs frontaux	14
SINGLEY Pincettes à saisir	247	TRELAT Spéculum vaginaux	115
SKENE Pince utérine	136	TREVES Pincettes à griffes	246
SMELLIE Crochet à obstétrique	185	Trocarts	371
SMELLIE Perce-crâne	186	Tube à aspiration rectal	64
SOFIELD Ecarteurs	307	Tubes conique de proctoscope	56
SOMER Pince hystérolabe	140	Tubes d'aspiration	367-370
Sonde métalliques p.femmes et hommes	102	Tubes d'aspiration pour Chirurgie bariatrique	367-370
Sondes à fistules	63,366	TUEBINGEN Ecarteur	316
Sondes cannelées	366	TUFFIER Pince Intestinal	27
Sondes cannelées/boutonnées	366	TURNBULL Pincettes à ongles	22
Sondes pour le canal cholédoque	76	TURNER-WARWICK Ecarteur abdominal	338-340
Sondes, feuille myrte	366		
Spéculum abdominal	336	U	
Spéculum rectaux	47-49	UNIVERSAL Trocarts	371
Spéculum vaginaux	107-127	USA-MODELE Pince presse-tube	299
Spéculum vaginaux antiréfléchissant p.Chir. LASER	111-114		
Spéculum vaginaux isolé p. Chirurgie HF	111-114	V	
SPENCER-WELLS Pincettes hémostatiques	279	Vaginoscope	109,173
Sphincteroscopes	52	VALLEIX Hystéromètre	130
St.MARKS Ecarteur à perinée	51	Valves rectales	47
St.MARKS Ecarteurs rectaux	62	VAN BUREN Bougies dilatatrices pour l'urètre	104
ST.MARKS Proctoscope	52,53	VAN DOREN Pince à biopsie utérine	155
STAUDE-MOORE Pince utérine	133	VANNAS-MICRO Ciseaux	209,212
STEINER-AUVARD Spéculum vaginal	116	VANNAS-MICRO Ciseaux, manche "Profil"	212
STELZNER Ciseaux pour rectum	59,223	Vasectomie, instruments	99
Stérilisation	373-395		
Stéthoscopes	12,198	W	
STILLE Pince rénale	88	WALDMANN Ciseaux à épisiotomie	180
STILLE Pincettes à dissequer	237	WALLICH Curette à faux germes	189
STILLE-BARRAYA Pincettes à griffes	248	WALTON Pincettes-tampons	302
STOCKMANN Pince pour pénis	103	WANGENSTEEN Pince à saisir	247
STONE Pince à griffes	246	WANGENSTEEN Pincettes à dissection PROMEDUR	253
STRATTE Porte-aiguilles	361	WANGENSTEEN Porte-aiguilles	361
STRATTE Porte-aiguilles PROMEDUR	357	WANGENSTEEN Porte-aiguilles PROMEDUR	356
STRAUSS Pince pour pénis	103	WASSMUND Ecarteur	308
STRAUSS Rectoscope	57	WAUGH Pincettes à griffes	248
STRINGER Etriers pour instruments	375	WEISSBARTH Spéculum vaginal	118
Stylets	365	WERTHEIM Ciseaux chirurgicaux	218
Stylets boutonnés	365	WERTHEIM Pincettes à hystérectomie	146,149,152
Stylets, Aspiration, Trocarts	365-371	WERTHEIM-ATRAUMA Pincettes à hystérectomie	151
Stylets-aiguille	365	WERTHEIM-CULLEN Pincettes à hystérectomie	151
Suture	345-361	WERTHEIM-DEBAKEY Pincettes à hystérectomie	153
		WIJNEN Tube d'aspiration	368,370
T		WIKSTROEM Pincettes à préparation	285
Tambours de stérilisation	390	WILLET Pince pour le cuir chevelu	187
Tapis port-instruments silicone	387	WILLIAMS Pince intestinale	29
TARNIER Basiotribe	186	WINTER Pincettes à faux germe	191
TARNIER Pince obstétricale	183	WITTNER Pincettes à biopsie utérine	160
TAYLOR Pincettes à griffes	245	WRIGLEY Pince obstétricale	181
TAYLOR-CUSHING Pincettes à griffes	245		
TEALE Pincettes utérines	138	Y	
Tensiomètres	9,10,11,196,197	YANKAUER Tubes d'aspiration	367
THOMAS Curettes utérines	165	YEOMAN Pincettes à biopsie rectale	71
THOMS-ALLIS Pince intestinale	28	YOUNG Ecarteurs à prostate	98
THOMS-GAYLOR Pince à biopsie utérine	155	YOUNG Pince à prostatectomie	95
THOMSON-WALKER Ecarteur vesical	101		
THOREK Ciseaux à préparation	218	Z	
TIEMANN Pince tire-balle	136	Z-HYSTEREKTOMIE Clamps	154
TISCHLER (Baggish) Pince à biopsie utérine	158	ZIEGLER Miroir frontal	14
TISCHLER Pince à biopsie utérine	158		
TISCHLER-BURKE Pince à biopsie utérine	158,159		
TISCHLER-KEVORKIAN Pince à biopsie utérine	158		
TISCHLER-MINI Pince à biopsie utérine	158		
TOHOKU Pincettes à champs	298		
TOWNSEND Curette à biopsie utérine	162		

INDICE ALFABETICO

A

ADAIR Pinze per collo dell'utero	134
ADLERKREUTZ Pinze chirurgiche	246
ADSON Pinze anatomiche	235,236
ADSON Pinze anatomiche PROMEDUR	253
ADSON Pinze chirurgiche	241,242
ADSON Pinze chirurgiche PROMEDUR	253
ADSON Pinze per preparazione e legature	277
ADSON Portaghi	360
ADSON-BABY Pinze emostatiche	277
ADSON-BROWN Pinze chirurgiche	246
ADSON-BROWN Pinze chirurgiche PROMEDUR	254,255
ADSON-DEBAKEY Pinze anatomiche	235
ADSON-GRAEFE Pinze chirurgiche	242
ADSON-MICRO Pinze anatomiche	235
ADSON-MICRO Pinze chirurgiche	241
ADSON-SELECT MICRO Pinze chirurgiche	241
ALAN-PARKS Divaricatore rettale	50
ALEXANDER Pinza per biopsia uterina	157
ALLEN-KOCHER Pinze emostatiche	27
ALLIS Pinza per tessuti e organi	27,292
ALLIS Pinze atraumatiche per tessuti e organi	28
ALLIS-ADAIR Pinza per tessuti e organi	28
ALLIS-BABY Pinza per tessuti e organi	27
AMANN porta garza uterino	131
Amnioscopi	172
Amniotomo	131
ANDREW-PYNCHON Tubo aspirazione	367
Anoscopi	52,53
AUVARD Specoli vaginali	116

B

BABCOCK Pinze per tessuti e organi	29,293
BABCOCK Pinze per tessuti e organi PROMEDUR	30
BABCOCK-DEBAKEY Pinze per tessuti e organi	30
BABY-ADSON Pinze emostatiche	277
BABY-ALLIS Pinza per tessuti e organi	27
BABY-BALFOUR Divaricatore addominale	329
BABY-COLLIN Divaricatore addominale	324
BABY-CRILE Pinze emostatiche	275
BABY-CRILE-WOOD Portaghi PROMEDUR	353
BABY-GELPI Divaricatore autostatico	322
BABY-KOCHER Pinze intestinali	33
BABY-LEXER Forbici per dissezione	218
BABY-METZENBAUM Forbici per preparazione	218
BABY-MIKULICZ Pinza per peritoneo	146
BABY-MIXTER Pinza per preparazione e legatore	285
BABY-OVERHOLT Pinza emostatica	283
BABY-PAYR Schiacciatore intestinale	44
Bacinelle per compresse	394
Bacinelle universali	395
BACKHAUS Pinze fissateli	297
BACKHAUS Pinze fissateli con porta-tubi	297
BAINBRIDGE Pinze emostatiche	279
BAKES Dilatatori per condotti biliare	76
BAKES Sonda per calcoli biliare	76
BALFOUR Divaricatori addominali	328-330
BALFOUR-BABY Divaricatore addominale	328
BALL e SOCKET Pinze fissateli	298
BALLENGER Pinze per tamponamento	300-304
BARNES-NEVILLE Forcipo obstetrico	184
BARR Divaricatore rettale	51
BARRET Pinza per il collo dell'utero	133
BARRON Legatore emorroidale aspiratrice	68
BARRON Manico per bisturi	203
BARRON Pinza per afferare	70
BARTON Forcipo obstetrico	183
BARTON Manico a trazione	183
Base per MINI-Container	383
Basiotribo	186
BEACHAM Amniotomo	131
BENGOLEA Pinze emostatiche	278

Página

BENSAUDE Anoscopi	53
BENSON Divaricatore per piloro	45
BERGER Pinze per biopsia uterina	161
BERGMANN-FOERSTER Pinze-tamponi	300
BERKELEY-BONNEY Pinza per isterectomia	150
BERNHARD Pinza fissateli	298
Bicchieri graduati	392
Bicchieri per medicina	394
Bile, Fegato, Rene	74-92
BILL Manico a trazione	184
Bipolar cavi per pinze	266
BIPOLAR Pinze NONSTICK	257-259
BIPOLAR Pinze per coagulazione	261-265
Bisturi per fibromi	145
BiTech Micro Forbici bibolari	228
BLAKE Curetta uterina	164
BLAKE Pinze per calcoli biliari	81
BLANK Pinze atraumatiche	237
BLESSING Forbici per chirurgia	60,225
BLOND Anoscopi	56
BLOND Tubi protoscopico	56
BODENMAMMER Specolo rettale	49
BOERMA Forcipo obstetrico	181
BONNEY Pinza anatomiche	238
BONNEY Pinza per dissezione	255
BONNEY Pinze chirurgiche	246
BONNEY Pinze chirurgiche PROMEDUR	254
BOYNTON Porthagi PROMEDUR	345
BOYS-ALLIS Pinza per tessuti e organi	28
BOZEMANN Forbici per Ginecologia/Ostetricia	179
BOZEMANN Pinze per tamponi e spugne	304
BOZEMANN Portaghi	360
BOZEMANN Portaghi PROMEDUR	355
BOZEMANN-DOUGLAS Pinza-tamponi	304
Bracciali per manometri	11,197
BRAUN Cranioclasto	186
BRAUN Depressore uterino	131
BRAUN Pinza per collo dell'utero	133
BRAUN Uncino di decapitazione	186
BRAUN-STADLER Forbici per perineo (Episiotomia)	180
BREISKY Divaricatori vaginali	124
BRIDGE Pinze per preparazione e legature	279
BROMPTON Pinza per drenaggio	299
BROPHY Pinze anatomiche	237
BROPHY Pinze chirurgiche	244
BROWN Pinze chirurgiche	247
BRYANT Pinza-tamponi e spugne	302
BUIE Cannula rettale	64
BUIE Pinza a pressione	43
BUIE Sonda per fistole	63
BULLDOG Pinze atraumatiche	269-272
BUMM Curette uterine	168-169
BUMM Pinza per polipi uterini	143,190
BUSCH Forbici ombelicale	179

Página

C

Candelette dilatatrici uretrali	104
Cannula per l'anestesia transvaginale del necvo pudico	188
Cannula rettale	64
Cannule per biopsia del fegato	87
Canule per aspirazione	367-370
CARREL Pinze emostatiche	273
Casetta de selezione tharghette	385
Cassette per strumenti per microcirurgia	390
CASTROVIEJO Portaghi	345
CASTROVIEJO Portaghi PROMEDUR	345
Cateteri metallici donne e uomini	102
Cavi bipolari per forbici "BiTech"	232
Cavi bipolari per pinze	266
Cestelli per strumenti endoscopica	384
Cestelli, griglia in metallo	377,379,381,383,385
CHAPUT Pinza per afferare tessuti	27
CHARNLEY Divaricatore addominale	341
CHEATLE Pinza per la sterilizzazione	374
CHERON Pinze per tamponi e spugne	304

	Página		Página
Circoncisione, strumento	103	DEAVER Divaricatori	314-317
Clamp per appendicectomia	45	DEAVER Divaricatori con manico "Comfort"	314
Clamps ombilicali	185	DEBAKEY Canule per aspirazione	368
CLAR lampada frontale	15	DEBAKEY Divaricatori autostatici	321
CLAR Riflettore frontale	14	DEBAKEY Pinze atraumatiche	240,250-252
CLAR Specchio frontale LUCE FREDO	15	DEBAKEY Pinze Bulldog atraumatiche	272
Clip - illuminazione luce fredda per anoscopi	54,173	DEBAKEY Pinze chirurgiche PROMEDUR	254
COLLER-CRILE Pinze emostatiche	276,287	DEBAKEY Pinze per cistifellea PROMEDUR	84
COLLIN Clamp ombelicale	185	DEBAKEY Pinze per tessuti e organi	32,83
COLLIN Dinamometro	19	DEBAKEY Pinze vascolari	250-252
COLLIN Divaricatori addominali	324	DEBAKEY Pinze vascolari TITANIO	250-252
COLLIN Manici per bisturi	202,204	DEBAKEY Portaghi ROMEDUR	354
COLLIN Pelvimetro	20,177	DEBAKEY-ADSON Pinze anatomiche	235
COLLIN Pinza per tessuti e organi	31	DEBAKEY-MICRO Pinze Bulldog atraumatiche	272
COLLIN Pinze per afferrare l'utero	140,141	DEBAKEY-MICRO Pinze vascolari	251
COLLIN Pinze per tamponi e spugne	304	DEBAKEY-MICRO Pinze vascolari TITANIO	251
COLLIN Specoli vaginali	112	DEBAKEY-WERTHEIM Pinze per isterectomia	153
COLLIN Specoli vaginali antiabbagliante per chirurgia LASER	112	DEMARTELL Forbici per il condotto biliare	84
COLLIN Specoli vaginali isolari per chirurgia HF	112	DEMARTEL-WOLFSON Pinze per anastomosi intestinali	46
COLLIN Speculo vaginale ber bambini	108	DENIS-BROWN Divaricatori addominali	331
COLLIN-BABY Divaricatore addominale	324	Depressori uterini	131
COLLIN-DUVAL Pinze intestinali	249	DESJARDINS Pinze per calcoli biliari	81
COLLIN-LOCKTITE Divaricatore addomenele	325	DESJARDINS Pinze per condotto biliare	79
COLLYER Pelvimetro	20,177	DESJARDINS Sonde per calcoli biliare	75
Container per Endoscopia	384	DEWEY Forcipo obstetrico	183
Container per sterilizzazione	376,378,380,382,384,390	Diagnostica	7-15,195-198
Container piatto per sterilizzazione	382	DICK Pinze de pressione	148
COOLEY Canule per aspirazione	369,370	DIETRICH Pinze Bulldog atraumatiche	271
COOLEY Pinze vascolari	251	Dilatatore per collo vescicale	96,100
COOLEY Pinze vascolari TITANIO	251	Dilatatori per condotti biliare	75,76
Coperchi di sicurezza per container	378,378,380	Dilatatori uterini	128,129
CORONAR Forbici	210	Dinamometro	19
COUPLAND Canula per aspirazione	367	Distributore per spazzole	23
CRAFOORD Forbici per lobectomia	221	Distributori de cotone	391
CRAFOORD Pinze emostatiche	281	Distributori di filtri	386
CRAFOORD-SELLORS Pinza emostatataca	289	DIU Pinze per mettere pessari	132
CRAFOORD-SELLORS Pinze per preparazione e legature	281	DIU Uncino per estrazione	132
Cranioclasto	186	Divaricatore per piloro	45
CRILE Pinze emostatiche	275	Divaricatore rettale per inserto a fibra ottica	50
CRILE Portaghi	359	Divaricatori	305-318
CRILE-BABY Pinze emostatiche	275	Divaricatori addominali	324-341
CRILE-COLLER Pinze emostatiche	276	Divaricatori autostatici	319-341
CRILE-MURRAY Portaghi	359	Divaricatori doppi	307,310
CRILE-RANKIN Pinze emostatiche	276	Divaricatori per fegato	85
CRILE-WOOD Portaghi	359	Divaricatori per seno renali	91,92
CRILE-WOOD Portaghi per mano SINISTRTRA	353	Divaricatori rettali	50-51,60,61
CRILE-WOOD Portaghi PROMEDUR	353	Divaricatori vaginali	124-126
CRILE-WOOD-BABY Portaghi PROMEDUR	353	Divaricatori vescicali	96,100-101,325,
Cucchiari per calcoli biliare	77,78	Divisore per container per sterilizzazione	377,379,381,389
Cucchiari per placenta ed aborto	189	DOUAY Pinze per biopsia uterina	157
Cucchiari uterini	164-166	DOYEN Divaricatore	312
Cucchiaio ostetrico	184	DOYEN Divaricatori addominali	336
Cucchiaio per medicina	394	DOYEN Forbici per Ginecologia/Ostetricia	179
Cucchiaio per secrezione	103	DOYEN Pinza per polipi	82
Curette per aspirazione	170	DOYEN Pinza per polipi uterini	142,190
Curette per biopsia	162-164	DOYEN Pinze intestinali	33
Curette uterine	164-169	DOYEN Sonda scanalate	366
CUSCO Specoli vaginali	110,111	DOYEN Specoli vaginali	125
CUSCO Specoli vaginali antiabbagliante per chirurgia LASER	111	DOYEN Tiramiomi	145
CUSCO Specoli vaginali isolari per chirurgia HF	111	DOYEN-DEBAKEY Pinze intestinali	37
CUSCO Specoli vaginali per bambini e vergini	107-109,118	DOYEN-STILLE Divaricatori	312
CUSHING Divaricatore	317	DUBOIS Forbici per decapitazione	180,186
CUSHING Pinze anatomiche PROMEDUR	253	DUEHRSEN Pinze anatomiche	238
CUZZI Cucchiaio per placenta ee aborto	189	DUEHRSEN Pinze chirurgiche	245
CZERNY Divaricatore doppio	307	DUNHILL Pinze emostatiche	275
CZERNY Pinza per collo dell'utero	133	DUPLAY Pinza per collo dell'utero	135
CZERNY Specolo rettale	47	DUPLAY Pinze per medicatura	303
		DUPLEX Stetoscopi	12,198
D		DURANTE Pinza per intestini	249
DARLING Divaricatori autostatici	321	DURANTE Pinze chirurgiche	248
DARTIGUES Pinza afferare il rene e utero	90,141	DUVAL Pinza per intestini	249
DAVIS Pinze per la sterilizzazione	374	DUVAL Pinze per tessuti e organi	31
DE LEE Forcipo obstetrico	182	DUVAL Pinze per tessuti e organi PROMEDUR	31
DE LEE Pelvimetro	177		

	Página		Página
E			
EASTMAN Specoli vaginali	123	GILLIES Pinza chirurgiche	242
Elevatore per testa	181	GILLIES Pinza chirurgiche PROMEDUR	254
ELLIOT Forcipi obstetrici	182	GIL-VERNET Divaricatori per seno renali	91
EMMET Pinza per tamponi e spugne	303	Ginecologia	106-173
EMMET Uncini per fistole	144	GLASSMANN Pinze atraumatiche	252
Endospecoli	127	GLOVER Pinze Bulldog atraumatiche	269
EPPENDORF Pinza per biopsia uterina	160	GOELET Divaricatore doppio	307
EWALD Pinza chirurgiche	241	GOODELL Dilatatore uterino	129
EWALD Pinze anatomiche	235	GOSSET Divaricatori addominali	327
EXACTA Sfigmometri	10,196	GOURDET Cucchiari uterini	165
F			
FANSLER-IVES Anoscopi	53,54	GRAVE Specali vaginali	113,115
FANSLER-IVES Anoscopio con luce fredda	54	GRAVE Specoli vaginali antiabbagliante per chirurgia LASER	113
FAURE Pinza per biopsia	156	GRAVE Specoli vaginali isolari per chirurgia HF	113
FAURE Pinza per peritoneo	147	GRAY Pinze per il condotto biliare	80
FEHLAND-DEBAKEY Pinza per amastomosi rettali	39	GREEN Divaricatore	310
FERGUSON Forbici per Ginecologia	179	GREEN-ARMYTAGE Pinza serra utero	187
FERGUSSON Pinze a pressione	43	GREGORY Portaghi DIAMANTATE	351
Fermafiltro per Container	386	GREGORY Portaghi PROMEDUR	351
FERRIS-SMITH Pinze chirurgiche	244	GROSS Pinze per medicatura	303
Filtri, carta per Container	386	GUNNAR-HEY Pinza per drenaggio	299
Filtri, tessile per Container	387	GUTTMAN Cucchiario per secrezione	103
FINOCHIETTO Portaghi	360	GUYON Candelette dilatatrici uretrali	104
FINOCHIETTO Portaghi PROMEDUR	355	GUYON Pinza renali	88,293,291
FLETCHER (JAVERTS) Pinza-tamponi	301	GUYON Strumenti per introdurre catetere	102
FLETCHER Pinze-tamponi	301	GWILLIAM Pinze per isterectomia	150
FOCUS Lampada frontale ALOGENO	15	H	
FOERSTER Divaricatore addominale, plastica, radiotrasparente	337	HALSTED Pinze emostatiche	277
FOERSTER Pinza-tamponi	293	HARRINGTON Pinza emostatica	292
FOERSTER Pinze per cistifellea	83,300	HARTMANN-MICRO Pinze emostatiche	273
FOERSTER Pinze-tamponi	300,301	HARTMANN-MOSQUITO Pinze emostatiche	274
Forbici	207-232	HASSISON Pinza per la sterilizzazione	374
Forbici bilobari	228-230	HAYES-DEBAKEY Pinze per anastomosi rettali	39
Forbici chirurgiche	215	HEANEY (Hegar) Portaghi	361
Forbici con taglio in carburo di tungsteno	222,224-227	HEANEY Pinze per isterectomia	149
Forbici delicate	214	HEANEY Portaghi PROMEDUR	356
Forbici delicate per MANO SINISTRA	214	HEANEY-BALLENTINE Pinze per isterectomia	149
Forbici e pinza bipolari	231	HEANEY-KANTER Pinze per isterectomia	149
Forbici ombelicale	179	HEANEY-REZEK Pinza per isterectomia	149
Forbici per decapitazione	180,186	HEGAR Dilatatori uterini	128,129
Forbici per dissezione	216-222	HEISS Pinze emostatiche	278
Forbici per dissezione PROMEDUR	222,225-227	HENROTIN Pinza per collo dell'utero	137
Forbici per Enterotomia	58	HERRICK Pinza renali	88
Forbici per episiotomia (perineo)	180	HERTZLER Divaricatore addominale	328
Forbici per Ginecologia/Ostetricia	179-181	HEYWOOD-SMITH Pinza per polipi	70
Forbici per il condotto biliare	84	HEYWOOD-SMITH Pinze per polipi uterini	83,142,190
Forbici per il retto	58,59,223	HILL-FERGUSON Valve rettale	47
Forbici per la cuticola	22	HIRSCHMANN Anoscopi	52
Forbici per lobectomia	221	HOESEL Divaricatori rettali	61
Forbici per MANO SINISTRA	214,215	HOLZBACH Divaricatore addominale	326
Forbici per operazione	224	HORGAN valve per divaricatori	330
Forbici per parametrio	60,217,225	HRYNYSCHAK Divaricatore vescicale	101
Forbici per perineo (episiotomia)	180	HULKA Pinza per collo dell'utero	135
Forbici per preparazione	219,221,222	HULKA-KENWICK Pinza per collo dell'utero	135
Forbici per unghie	22	I	
Forcipi obstetrici	181-184	Inserto per Proctoscopi fibra ottica	50,53,109
FORD-DIXON Legatore emorroidale	66	IOWA Guida per aghi cannule (tromba)	188
FRANKLIN-SILVERMAN Cannule per biopsia del fegato	87	IOWA Pinza rompimembrana	188
FRITSCH Divaricatori	313	ISRAEL Divaricatori	309
FUCHSIG Pinza emostatiche	278	Isterometri	130
G			
Ganci a cripta	63	Isterosalpionografia	171
GAUSS Pinza per pericraneone	187	J	
GELPI Divaricatori autostatici	322,323	JACKSON Specoli vaginali	123
GELPI-BABY Divaricatore autostatico	322	JACKSON-BURROWS Divaricatore autostatico	323
GELPI-MINI Divaricatore autostatico	322	JACOBS Pinze per collo dell'utero	138
GELPI-SELETZ Divaricatore autostatico	323	JACOBSON-MICRO Pinze emostatiche	274
GEMINI Pinze emostatiche	284,293	JARCHO Pinza per collo dell'utero	134
GEMINI-MINI Pinze emostatiche	284	JEFFERSON Pinza chirurgiche	242
GERALD Pinze chirurgiche	244	JEFFERSON Pinze anatomiche	236
GERALD Pinze chirurgiche PROMEDUR	254	JOHN-HOPKINS Pinza per condotto biliare	80
		JOHNSON Portaghi	360
		JOLL (Friedmann) Divaricatore vaginale autosatico	126,321

	Página		Página
JONES Pinze fissateli	297	Manici a batterie per Anoscopi	55
JUDD-ALLIS Pinze per tessuti e organi	28	Manici a luzce fredda per Anoscopi	55
JUDD-MASON Divaricatori vescicali	100,101	Manici a trazione per Forcipi obstetrici	183,184
K		Manici per bisturi	199,201,202-2035
KALLMORGEN Specoli vaginali	122	Manici per bisturi "PRO-MEDSEKUR™"	201
KANE Clamp ombelicale	185	Manici per micro bisturi	199
KANTROWITZ Pinze emostatiche	284	Manici per pinze per biopsia uterina	159
KELLY Divaricatori	85,311	MANO SINISTRA forbici	214,215
KELLY Pinza per aborto e placenta	191	MANO SINISTRA Portaghi	353,354
KELLY Pinze emostatiche	275	Manometri	9,10,195,196
KELLY Sfinteroscopi	52	MARBERGER Divaricatori per seno renali	91
KELLY-RANKIN Pinze emostatiche	276	MARINUS Pinze intestinali atraumatichi	42
KERSTING Pinza per anastomosi rettali	40	MARTEL Pinza per pericraneo	187
KEVORKIAN Curette per biopsia	162	MARTIN Isterometri	130
KEVORKIAN Pinza per biopsia uterina	161	MARTIN Pelvimetro	20,177
KEVORKIAN-PACIFIC Pinza per biopsia uterina	158	MARTIN Pinza per bendaggi usati	374
KIELLAND Forcipo obstetrico	181	MASSON Portaghi	361
KIELLAND-LUIKART Forcipo obstetrico	182	MASSON Portaghi PROMEDUR	356
KIRSCHNER Divaricatori addominali	332	MATHIEU Pinze per corpi estranei	103
KLEINSCHMIDT clamp per appendicectomia	45	MATHIEU Portaghi PROMEDUR	358
KLING-EX Levare-lame	205	MATHIEU Specolo rettale	49
KLINIKUM BERLIN Pinza serratubi	299	MATHIEU-KOCHER PROMEDUR	358
KOCHER Pinze intestinali	34	MAYO Cuchia per calcoli biliare	77
KOCHER-BABY Pinze intestinali	33	MAYO Forbici per dissezione	216
KOCHER-DEBAKEY Pinze intestinali	38	MAYO Forbici per dissezione PROMEDUR	222
KOCHER-WAGNER Divaricatori	313	MAYO-ADAMS Divaricatore addominale	325
KOERTE Divaricatori	308	MAYO-BLAKE Pinze per calcoli biliari	82
KOGAN Endospecoli	127	MAYO-GUYON Pinza renali	88
KONRICH scatole per sterilizzazione	390	MAYO-HARRINGTON Forbici per dissezione	217
KRISTELLER Divaricatori vaginali	126	MAYO-HARRINGTON Forbici per operazione PROMEDUR	224
KRISTELLER Specoli vaginali	108,118-121	MAYO-HEGAR Portaghi	359
KRISTELLER Specoli vaginali per vergini	108	MAYO-HEGAR Portaghi per mano SINISTRA	354
KÜSTNER Pinza per collo dell'utero	139	MAYO-HEGAR Portaghi PROMEDUR	354
L		MAYO-LEXER Forbici PROMEDUR	224
LAHEY Divaricatori	309	MAYO-NOBLE Forbici per dissezione	217
LAHEY Pinza per il condotto biliare	79	MAYO-ROBSON Pinze intestinali	35
Lame per bisturi	199,200,203	MAYO-RUSSIAN Pinza chirurgiche	247
LANDAU Divaricatori vaginali	124	MAYO-STILLE Forbici per dissezione	216
LANDOLD Manici per micro bisturi	199	McGIVNEY Legatgore emorroidale	65,69
LANE Pinze chirurgiche	247	McGIVNEY Pinze per emorroidi	70
LANE Pinze fissateli	298	McINDOE Pinza anatomiche	236
LANGENBECK Portaghi PROMEDUR	355	McINDOE Pinza chirurgiche PROMEDUR	254
LANG-STEVENS Pinze intestinali	33	McLEAN Forcipo obstetrico	183
LATERAL Divaricatore vaginale autosatico	127	McLEAN-LUIKART Forcipi obstetrici	183
LAWRENCE Pinza per preparazione e legatore	285	MEEKER Pinza per preparazione e legatore	285
Legatori emorroidali	65-69	MENGHINI Cannule per biopsia del fegato	87
LEGUEU Divaricatore vescicale	325	METZENBAUM Forbici per preparazione	219,221,222
LEGUEU Spatola vescicali	97	METZENBAUM Forbici PROMEDUR	226
LERCHE Pinza chirurgiche	246	METZENBAUM Portaghi	360
Levare-lame	205	METZENBAUM-BABY Forbici per preparazione	218
LEXER-BABY Forbici per dissezione	218	METZENBAUM-FINO Forbici per preparazione	220
LICHTENBERG Portaghi PROMEDUR	358	METZENBAUM-FINO Forbici PROMEDUR	227
LICHTWITZ Trequarto	371	Micro Forbici	209-213
Lime per unghie	23	Micro Forbici bibolari	228
LISTER-SINUS Pinze-tamponi	302	Micro lame per bisturi	199
LITTAUER Tronchesine per unghie	22	Micro Portaghi	345-352
LITTLEWOOD Pinza per tessuti e organi	28	Micro Portaghi DIAMAMTATE	349-351,353
LLOYD-DAVIS Forbici per il retto	59,223	Micro Portaghi PROMEDUR	347-349
LLOYD-DAVIS Pinza per anastomosi rettale	43	Micro Portaghi TITANIO	350-351,353
LOCKHART-MUMMERY Sonde per fistole	63,366	MICRO-DEBAKEY Pinze Bulldog atraumatiche	272
LOCKWOOD Pinza per tessuti e organi	29	MICRO-HARTMANN Pinze emostatiche	273
LORNA Pinze fissateli	298	MICRO-JACOBSON Pinze emostatiche	274
LOWER Pinza per condotto biliare	80	MICRO-MOSQUITO Pinze emostatiche	274
LUER-KOERTE Cuchia per calcoli biliare	78	MICRO-VASCULAR Portaghi PROMEDUR DIAMANTATE	353
LUIKART Forcipo obstetrico	182	MIDDELDORF Divaricatori	310
LUIKART-BILL Manico a trazione	184	MIKULICZ Divaricatori per fegato	85
LURZ Legatore emorroidale aspiratrice	66	MIKULICZ Pinze per peritoneo	146
LURZ Pinze per uretere	96	MIKULICZ-BABY Pinza per peritoneo	146
M		MILLER Forbici per il retto	58
MAIER Pinze per medicatura	303	MILLIN Divaricatore per prostatectomia	100
MAINGOT Pinze per isterectomia	150	MILLIN Dilatatore per collo vescicale	96,100
		MILLIN Pinza per afferare lobuli anteriori	95
		MILLIN Pinza portafilo	95
		MILLIN Pinze per afferare la prostata	95
		MILLS Forbici per il condotto biliare	84

	Página		Página
MINI Container piatto per sterilizzazione	382	PELKMANN Pinze-tamponi	302
MINIMUS II Sfigmometro	10,196	Pelvimetri	20,177
Misurini graduati	392	PENNINGTON Pinze per tessuti e organi	27
MIXTER Pinza per calcoli biliari	82	Perne di fissaggio per divisori e strumenti	389
MIXTER Pinza per condotto biliare	80	PESTALOZZA Cucchiaino per placenta ed aborto	189
MIXTER Pinze emostatiche	286	PETRI Scodella	392
MIXTER-BABY Pinze per preparazione e legatore	285	PHANEUF Pinze per peritoneo	148
MIXTER-O'SHAUGHNESSY Pinze per preparazione	283	PINARD Stetoscopi fetali	12,198
MOGEN Strumento per circoncisione	103	Pinza afferare il rene e utero	90,141
MOORE Cucchiaino per calcoli biliare	77	Pinza apri flebo	375
MORGAN Proctoscopi	53	Pinza per fissare il tronco spermatico	96
MORRIS Divaricatore autostatico	323	Pinza per microbiopsia uterina	161
MORRIS Divaricatori	312	Pinza per pericraneio	187
MORRIS Divaricatori doppi	307	Pinza rompimembrana	188
MOSQUITO Pinze emostatiche	274	Pinze	233-266
MOSQUITO-MICRO Pinze emostatiche	274	Pinze a pressione	43
MOYNIHAN Exploradore per calcoli biliare	75	Pinze anatomiche FINO	237
MOYNIHAN Pinza fissateli	298	Pinze anatomiche Modello "USA"	237
MOYNIHAN Pinze per condotto biliare	79	Pinze atraumatiche	240,250-252
MÜNCHEN Curette per biopsia	163	Pinze atraumatiche PROMEDUR	250-253
MURLESS Elevatore per testa	181	Pinze atraumatiche TITANIO	250,251
MUSEUX Pinze per collo dell'utero	139	Pinze bipolari	261-265
		Pinze bipolari NONSTICK	257-259
N		Pinze bipolari per coagulazione	256-265
NAEGELE Forcipo obstetrico	181	Pinze Bulldog atraumatiche	269-272
NAEGELE Spezzacrano	186	Pinze calcoli renali	89
NAGEL Micro-Forbici	213	Pinze chirurgiche	241-248
Nastri medico	19	Pinze chirurgiche FINO	243
NAUNTON-MORGAN Portaghi PROMEDUR	357	Pinze chirurgiche Modello USA	243
Necessario per infermeria	23	Pinze de pressione	148
NEIVERT Portaghi	359	Pinze di fillaggio per teli	388
NEIVERT Portaghi PROMEDUR	353	Pinze emostatiche	273-276,280
NELATON Sonda bottonuta scanalata	366	Pinze emostatiche e per preparazione	237-293
NELSON Pinze chirurgiche	246	Pinze emostatiche per chirurgia bariatrica	287-293
NELSON Tre quarti	371	Pinze fissateli, serratubi, tamponi	295-304
NISSEN Pinza emostatica	278	Pinze intestinali	33-46
NONSTICK Pinze bipolari	257-259	Pinze per aborto e placenta	191
NOTO Pinza per polipi uterini	143,190	Pinze per afferare	240,247,249
NOVAK Curette per biopsia	163	Pinze per afferare la prostata	95
NOVA-PRESAMETER Sfigmometro	9,195	Pinze per afferrare l'utero	141-141
NUSSBAUM Pinze intestinali	36	Pinze per anastomosi intestinali	46
		Pinze per anastomosi rettali	38-40
O		Pinze per bendaggi con recipiente	393
Occhiali a lenti binoculari	13	Pinze per bendaggi usati	374
OCHSNER Tre quarti	371	Pinze per biopsia rettale	71
OCULUS Occhiali a lenti binoculari	13	Pinze per biopsia uterina	156-161
OEHLER Pinze chirurgiche PROMEDUR	255	Pinze per calcoli biliari	81,82
Olio per la pulizia degli strumenti	391	Pinze per cistifellea	83,300
OLLIER Divaricatori	308	Pinze per dissezione	235-239
OLVECRONA Pinze emostatiche	281	Pinze per drenaggio tubi con rulli	299
OMBREDANNE Pinza fissateli	297	Pinze per il collo dell'utero	133-139
OMBREDANNE Pinza per intestino	29	Pinze per il condotto biliare	79,80
Ostetricia	176-191	Pinze per isterectomia	149-154
Ostetricia	176-191	Pinze per la sterilizzazione	374,375
O'SULLIVAN-O'CONNOR Divaricatori addominali	334	Pinze per medicaturas	300-304
OVERHOLT-BABY Pinza emostatica	283	Pinze per pericraneio	187
OVERHOLT-GEISSENDOERFER Pinze emostatiche	283	Pinze per peritoneo	146-148
OVERHOLT-MIXTER Pinza emostatica	283	Pinze per polipi uterini	83,142,143,190
		Pinze per preparazione e legature	277-279,281-286
P		Pinze per rifiuti	374
Padelle reniforme	393	Pinze per tamponamento	300-304
Panni di sterilizzazione	387	Pinze per tessuti e organi	27-32
PARAMETRIUM Forbici	60,225	Pinze per trapiantare del fegato	86
PARKS Divaricatore rettale per inserto a fibra ottica	50	Pinze per uretere	90,96
PAYR Schiacciatore intestinale	44	Pinze per vasectomia	99
PAYR-BABY Schiacciatore intestinale 18 c	44	Pinze PROMEDUR	253-255
PEAN Pinze emostatiche	279	Pinze renali	88
PEAN-FINO Pinze emostatiche	280	Pinze serra utero	187
PEDERSON Specoli vaginali	114	Pinze serrapene	103
PEDERSON Specoli vaginali antiabbagliante per chirurgia LASER	114	Pinze serratubi	299
PEDERSON Specoli vaginali isolari per chirurgia HF	114	PIPER Forcipi obstetrici	182,184
PEDERSON Speculo vaginale per vergini	107,114	PITTSBURG Pinze per trapiantare del fegato	86
PEERS Pinza fissateli per fazzoletti di carta	297	POOLE Canule per aspirazione	368,370
		Porta garza uterino	131
		Portacotone e tamponi	64

	Página		Página
POTTS-DE-MARTEL Forbici per il condotto biliare PROMEDUR	84	SCHUMACHER-VAN DOREN Pinza per biopsia uterina	155
POTTS-SMITH Forbici per il condotto biliare	84	Scodelle in acciaio inossidabile	391-395
POTTS-SMITH Pinze anatomiche	238	Scodelle rotonde	393
POTTS-SMITH Pinze anatomiche PROMEDUR	253	SCUDDER Pinze intestinali	35
POTTS-SMITH Pinze chirurgiche	245	SCUDDER-DEBAKEY Pinze intestinali	41
POZZI Pinza per collo dell'utero	134	SEGOND Bisturi per fibromi	145
PRATT Ganci a cripta	63	SEGOND Pinza per isterectomia	149
PRATT Pinze per collo dell'utero	137	SEGOND-LANDAU Pinza per isterectomia	149
PRATT Specolo rettale	49	SELLHEIM Cucchiaino ostetrico	184
PRATT-"T" Pinza emostatiche	32	SEMKEN Pinze anatomiche	236
PRECISA Sfigmometro	9,195	SEMKEN Pinze chirurgiche	242
Preparazione, Dermatologia	21-24	SEMKEN Pinze chirurgiche PROMEDUR	253
PRESBYTERIAN Pinze serratubi	299	SEMM Divaricatore addominale	333
Proctoscopi	52,53,56	SEMM Specoli vaginali	115
Proiettore Luce Fredda Alogeno	15,57	SEYFFERT Specoli vaginali	115
PRO-MEDSEKUR™ Manici per bisturi	201	Sfigmometri	9,10,195,196
PROVIDENCE-HOSPITAL Pinze emostatiche	275	Sfinteroscopi	52
R			
RAMATHIBODI Manipolatore uterino	132	SIEBOLD Forbici per Ginecologia	179
RAMATHIBODI unchino tubular	132	Sigilli di sicurezza per sterilizzazione	385
RAMPLEY Pinze-tamponi	301	SIMON Cucchiaini uterini	164
RAMSAY Pinza anatomiche	238	SIMON Divaricatori vaginali	125
RAMSEY Pinze chirurgiche	245	SIMON Uncini per fistole	144
RANDALL Curetta per biopsia	163	SIMPSON Forcipo obstetrico	181
RANDALL Pinze per calcoli renali	89	SIMPSON-BRAUN Forcipo obstetrico	182
RANKIN-CRILE Pinze emostatiche	276	SIMPSON-LUIKART Forcipo obstetrico	182
RANKIN-KELLY Pinze emostatiche	276	SIMS Curette uterine	166
RECAMIER Curette uterine	167	SIMS Depressore uterino	131
Recipiente per cotone usato	391	SIMS Forbici per Ginecologia/Obstetrica	178
Recipienti cilindrici	394	SIMS Forbici PROMEDUR	224
RESANO Pinza per anastomosi rettali	40	SIMS Isterometri	130
RICARD Divaricatore addominale	326	SIMS Specoli vaginali	123
RICHARDSON Divaricatori	310	SIMS Specolo rettale	48
RICHARDSON-EASTMAN Divaricatori doppi	310	SIMS-MAIER Pinze per medicatura	302
Riflettore frontale	14	SINGLEY(TUTTLE) Pinza per afferrare	240
Righe	19	SINGLEY(TUTTLE) Pinze chirurgiche	247
ROBERTS Pinze emostatiche	280	SKENE Pinza per collo dell'utero	136
ROBIN-MASSE Divaricatore addominale	327	SMELLIE Spezzacrano	186
ROCH.-OCHSNER Pinze emostatiche	282	SMELLIE Uncino ostetrico	185
ROCHARD Divaricatori addominali	335	SOFIELD Divaricatori doppi	307
ROCHESTER-CARMALT Pinze emostatiche	279	SOMER Pinza per afferrare l'utero	140
ROCHESTER-OCHSNER Pinze emostatiche	292,290	SONDA bottonute scanalate	366
ROCHESTER-PEAN Pinze emostatiche	280,288	Sonde "mirto"	366
ROEDER Pinze fissateli	298	Sonde bottonute	365
ROGGE Pinza per la sterilizzazione	374	Sonde bottonute scanalate	366
ROTOCLETTE Curette per biopsia	162	Sonde con oculo	365
RUDD Legatgore emorroidale	65	Sonde per calcoli biliari	75
RUMEL Pinze emostatiche	284	Sonde per fistole	63,366
RUSSIAN Pinze chirurgiche	239,247	Sonde scanalate	366
S			
SAENGER Pinza aborto e placenta	191	SPAZZOLE per mano	24
SALING Amnioscopi	172	Specili, Aspirazione, Trequarti	363-371
SANTULLI Pinza Bulldog atraumatiche	271	Specilli bottonuti	365,366
SAROT Pinza emostatataca	289	Specoli rettali	48-51
SAROT Portaghi	361	Specoli vaginali	107-127
SAROT Portaghi PROMEDUR	357	Specoli vaginali per bambine e vergini	108
SAUERBRUCH Pinza per bendaggi usati	374	Specolo addominale	336
SAUERBRUCH Scatola per aghi	392	SPENCER-WELLS Pinze emostatiche	279
Scatole per aghi	391,392	Spezzacrani	186
Scatole per sterilizzazione	390	St.MARKS Divaricatore pelviano	51
Scatole per strumenti	395	St.MARKS Divaricatori rettali	62
SCHAEDEL Pinza fissateli	297	ST.MARKS Proctoscopio	52
SCHERBAK Specoli vaginali	117	STAUDE-MOORE Pinza per collo dell'utero	133
Schiacciatori intestinali	44	STELZNER Forbici per il retto	59,223
SCHIMMELBUSCH scatole per sterilizzazione	390	Sterilizzazione	373-395
SCHROEDER Curette uterine	164	Stetoscopi	12,198
SCHROEDER Pinze per collo dell'utero	134,136	STILLE Pinza renali	88
SCHUBERT Pinza per biopsia uterina	156	STILLE Pinze anatomiche	237
SCHULTZE Isterosalpionografo	171	STILLE-BARRAYA Pinze chirurgiche	248
SCHULZE-BERGMANN Specoli rettali	48	STOCKMANN Pinza serrapene	103
SCHUMACHER Forbici ombelicale	179	Stomaco, Intestini, Retto	25-71
SCHUMACHER Pinze per biopsia uterina	160	STONE Pinza chirurgiche	246
		STRATTE Portaghi	361
		STRATTE Portaghi PROMEDUR	357
		STRAUSS Pinza serrapene	103
		STRAUSS Rettoscopio fibra ottica	57
		Strisce per fissaggio strumenti	388

	Página
Strumenari raccomandati per BILE, FEGATO, RENE	74
Strumenari raccomandati per GINECOLOGIA	106
Strumenari raccomandati per OSTETRICIA	176
Strumenari raccomandati per UROLOGIA	94
Strumentari raccomandati per STOMAGO, INTESTINALE, RETTO	26
Strumenti di paragone	17-20
Strumenti generali	195-371
Strumenti per introdurre catetere	102
Strumento per circoncisione	103
Supporti a molle	388
Sutura	343-361

T

Tapetti porta-strumenti in silicone	387
Targhette con indicatore chimico	385
Targhette di identificazione	385
TARNIER Basiotribo	186
TARNIER Forcipo obstetrico	183
TAYLOR Pinze chirurgiche	245
TAYLOR-CUSHING Pinze chirurgiche	245
TEALE Pinze per collo dell'utero	138
Telai fissateli per container per sterilizzazione	377,379,381,383
THOMAS Curette uterine	165
THOMS-ALLIS Pinza per tessuti e organi	28
THOMS-GAYLOR Pinza p. biopsia	155
THOREK (HALLE) Forbici per dissezione	218
THOREK Forbici per dissezione	218
TIEMANN Pinza per collo dell'utero	136
Tiramiomi	145
TISCHLER (Baggish) per biopsia uterina	158
TISCHLER Pinza per biopsia uterina	158
TISCHLER-BURKE Pinza per biopsia uterina	158
TISCHLER-KEVORKIAN per biopsia uterina	158
TISCHLER-MINI Pinza per biopsia uterina	158
TOHOKU Pinze fissateli	298
Tonchesine per unghie	22
TOWNSEND Curetta per biopsia	162
TOWNSEND-BURKE Pinza per biopsia uterina	159
TOWNSEND-KERVORKIAN Pinza per biopsia uterina	159
TOWNSEND-KRAUSE Pinza per biopsia uterina	159
TOWNSEND-MINI Pinze per biopsia uterina	159
TOWNSEND-TISCHLER Pinze per biopsia uterina	159
Trasformatore per riflettore	14
TRELAT Specoli vaginali	115
Trequarti	371
TREVES Pinze chirurgiche	246
Tubi d'aspirazione	367-370
Tubi protoscopico	56
TUEBINGEN Divaricatore	313
TUFFIER Pinza per tessuti e organi	27
TURNBULL Tronchesine per unghie	22

U

ULRICH Pinze per tamponi e spugne	303
Uncini per cordone spermatico	99
Uncini per fistole	144
Uncino di decapitazione	186
Uncino ostetrico	185
UNIVERSAL Trequarti	371
Urologia	94-104
USA-MODELO Pinza serratubi	299

V

Vaginoscopio, fibra ottica per vergini	109,173
VALLEIX Isterometro	130
Valve rettale	47
VAN BUREN Candelette dilatatrici uretrali	104
VAN DOREN Pinza p. biopsia	155
VANNAS-Micro Forbici	209

W

WALDMANN Forbici per episiotomia	180
WALLICH Cucchiaino per placenta ed aborto	189
WALTON Pinze-tamponi	302
WANGENSTEEN Pinza per afferare	247
WANGENSTEEN Pinze per afferare PROMEDUR	253
WANGENSTEEN Portaghi	361
WANGENSTEEN Portaghi PROMEDUR	356
WASSMUND Divaricate	308
WAUGH Pinze chirurgiche	248
WERTHEIM Forbici chirurgiche	218
WERTHEIM Pinza per peritoneo	146
WERTHEIM Pinze per isterectomia	149,152
WERTHEIM-ATRAUMA Pinza per isterectomia	151
WERTHEIM-CULLEN Pinza per isterectomia	151
WERTHEIM-DEBAKEY Pinze per isterectomia	153
WIJNEN Canula per aspirazione	368,370
WIKSTROEM Pinze emostatiche	285
WILLET Pinza per pericraneio	187
WILLIAMS Pinza per tessuti e organi	29
WINTER Pinze per aborto e placenta	191
WITTNER Pinze per biopsia uterina	160
WRIGLEY Forcipo obstetrico	181

Y

YANKAUER Canule per aspirazione	367
YEOMAN Pinze per biopsia rettale	71
YOUNG Pinza per afferare la prostata	95

Z

ZIEGLER Riflettore frontale	14
Z-ISTEREKTOMIA Pinze per isterectomia	154

INDICE ALFABÉTICO

A

Abdominal Especulo autoestático	336
Abre-botellas de infusión	375
ADAIR Pinzas para cuello uterino	134
Adaptador luz fría para Proctoscopios,	50,53,109
ADLERKREUTZ Pinzas quirúrgicas	246
ADSON Pinzas anatómicas	235,236
ADSON Pinzas de disección PROMEDUR	253
ADSON Pinzas hemostáticas	277
ADSON Pinzas quirúrgicas	241,242
ADSON Porta-agujas	360
ADSON-BABY Pinzas hemostáticas	277
ADSON-BROWN Pinza de disección PROMEDUR	255
ADSON-BROWN Pinzas quirúrgicas	246
ADSON-DEBAKEY Pinzas anatómicas	235
ADSON-GRAEFE Pinzas quirúrgicas	242
ADSON-MICRO Pinzas anatómicas	235
ADSON-MICRO Pinzas quirúrgicas	241
ADSON-MICRO Pinzas quirúrgicas	241
ADSON-SELECT Pinzas quirúrgicas	241
ALAN-PARKS Espéculo rectal	50
ALEXANDER Pinza para biopsia uterina	157
ALLEN-KOCHER Pinzas para tejidos y organos	27
ALLIS Pinza intestinal atraumatica	28
ALLIS Pinza intestinale atraumatica	28
ALLIS Pinzas para tejidos y organos	27
ALLIS Pinzas para tejidos y organos	27,292
ALLIS-ADAIR Pinza para tejidos y organos	28
ALLIS-BABY Pinza para tejidos y organos	27
AMANN Guida-tampónes	131
Amnioscopios	172
Amniotómo	131
ANDREW-PYNCHON Cánula de aspiración	367
Anoscopios	52,53,55
Apoyos con resorte spiral singular	388
Arandelas de goma para ligadores	65
AUVARD Espéculos vaginales	116

B

BABCOCK Pinzas intestinales	29
BABCOCK Pinzas intestinales PROMEDUR	30
BABCOCK-DEBAKEY Pinzas intestinales	30
BABY-ADSON Pinzas hemostáticas	277
BABY-ALLIS Pinzas para tejidos y organos	27
BABY-BALFOUR Separador abdominal	328
BABY-COLLIN Separador abdominal	324
BABY-CRILE Pinzas hemostáticas	275
BABY-CRILE-WOOD Porta-agujas PROMEDUR	353
BABY-KOCHER Pinzas intestinales	33
BABY-LEXER Tijeras para preparaciones	218
BABY-METZENBAUM Tijeras para preparaciones	218
BABY-MIKULICZ Pinza para peritoneo	146
BABY-MIXTER Pinzas de disección y ligaduras	285
BABY-PAYR Pinza intestinale para píloro	44
BACKHAUS Pinzas de campo	297
BAINBRIDGE Pinzas intestinales	279
BAKES sondas para conducto biliares	76
BALFOUR brazos para separadores	330
BALFOUR Separadores abdominales	328-330
BALFOUR-BABY Separador abdominal	328
BALFOUR-Modif. Separadores abdominales	330
BALL e SOCKET Pinzas de campo	298
BALLENGER Pinzas para curaciones	300
BALLENGER Pinzas para curaciones	300
Bandejas para esterilización	377,379,381,373,384
Bandejas para instrumentos	395
Bandejita para tabletas	394
BARNES-NEVILLE Forceps obstétrico	184
BARR Espéculo rectal	51
BARRET Pinza uterina	133
BARRON Mango de bisturi	203
BARRON Ligador para hemorroïdes	68

Pagina

BARRON Pinza para coger hemorroïdes	70
BARTON Forceps obstétrico	183
BARTON Tractor	183
BEACHAM Amniotómo	131
BENGOLEA Pinzas hemostáticas	278
BENSAUDE Anoscopios	53
BENSON Separador para píloro	45
BERGER Pinzas para biopsia uterina	161
BERGMANN-FOERSTER Pinzas para curaciones	300
BERKELEY-BONNEY Pinza para histerectomia	150
BERNHARD Pinza de campo	298
Billis, Higado, Riñón,	75-92
BILL Tractor	184
BIPOLAR Pinzas para coagulación	257
Bipolar Tijeras para coagulación	228-230
BIPOL-Cables para Pinzas-Tijeras bipolares	232
BIPOL-Cables para Tijeras "BiTech"	232
BiTech Tijeras bipolares	228
BLAKE Cureta uterina	164
BLAKE Pinzas para cálculos biliares	81
BLANK Pinzas de disección atraumáticas	237
BLESSING Tijeras para recto	60,225
BLOND Anoscopios con obturador	56
BLOND Tubos cónicos para proctoscopios	56
BODENHAMMER Espéculo rectal	49
BOERMA Forceps obstétrico	181
BONNEY Pinza anatómica PROMEDUR	254
BONNEY Pinza de disección promedur	255
BONNEY Pinzas anatómicas	238
BONNEY Pinzas quirúrgicas	246
BOYNTON Porta-agujas	345
BOYS-ALLIS Pinza para tejidos y organos	28
BOZEMANN Pinzas para curaciones	304
BOZEMANN Porta-agujas	360
BOZEMANN Porta-agujas PROMEDUR	355
BOZEMANN Tijeras para ginecología	179
BOZEMANN-DOUGLAS Pinzas para curaciones	304
BRAUN Craneoclasto	186
BRAUN Depresor uterino	131
BRAUN Gancho para decapitación	186
BRAUN Pinzas para cuello uterino	133
BRAUN-STADLER Tijeras para episiotomia	180
Brazaletes para Tensiómetros	11,197
BREISKY Separdores vaginales	124
BRIDGE Pinzas hemostáticas	279
BROMPTON Pinza para drenaje	299
BROPHY Pinzas de disección	237
BROPHY Pinzas quirúrgicas	244
BROWN Pinzas quirúrgicas	247
BRYANT Pinzas para tampones	302
BUIE Cánulas de aspiración	64
BUIE Pinza de presión	43
BUIE Sonda para fistulas	63
Bujias dilatadoras uretrales	104
BUMM Curetas uterinas	168-169
BUMM Pinza p. polipos uterinos	143,190
BUNT Clavijas de esterilización	375
BUSCH Tijerasumbilicales	179

C

Cables de conecion para pinzas bipolares	266
Cables para Pinzas-Tijeras bipolares	232
Cables para Tijeras "BiTech"	232
Cajas para instrumentos	395
Cajas para instrumentos con tapa	395
Cajas quirurgicas para BILIS, HIGADO, RINON	74
Cajas quirurgicas para ESTOMAGO, INTESTINO, RECTO	26
Cajas quirurgicas para GINECOLOGIA	106
Cajas quirurgicas para OBSTETRICA	176
Cajas quirurgicas para UROLOGIA	94
Cánula para anestesia transvaginal	188
Cánulas de aspiración	367-370
Cánulas de aspiración	64,367-370
Cánulas para biopsia	87
CARREL Pinza hemostática	273

	Pagina		Pagina
CASTROVIEJO Porta-agujas	345	CZERNY Pinza para cuello uterino	133
CASTROVIEJO PROMEDUR Porta-agujas	345	CZERNY Separador doble	307
Catéteres metalicas	102		
Cepillos a mano autoclavables	23	D	
Cestillos, acero para esterilización	377,379,381,383,385	DARLING Separador	321
CHAPUT Pinza para tejidos y organos	27	DARTIGUES Histérolabe	90,141
CHARNLEY Separador abdominal	341	DARTIGUES Pinzas coger para el útero	90,141
CHEATLE Pinza para esterilización	374	DAVIS Pinzas para esterilización	374
CHERON Pinza para curaciones	304	De LEE Forceps obstétrico	182
Clamps Bulldog atraumáticas	269-272	DE LEE Pelvimetro	177
Clamps intestinales	39-42	DEAVER Separadores	314-316,317
Clamps para cordon ombilical	185	DEBAKEY Cánulas de aspiración	368
CLAR Espejo frontal Ø 33 mm LUZ FRIA	15	DEBAKEY Clamps Bulldog atraumáticas	272
CLAR Espejos frontales	14	DEBAKEY Pinza vascular	240
Clavijas de esterilización	375	DEBAKEY Pinzas de disección PROMEDUR	254
CLIP - luz fria para proctoscopios	54,173	DEBAKEY Pinzas para tejidos y organos	32,83
COLLER-CRILE Pinzas hemostáticas	276	DEBAKEY Pinzas vasculares	250
COLLIN Clamp ombilical	185	DEBAKEY Pinzas vasculares TITANIO	250-251
COLLIN Dinamómetro	19	DEBAKEY Porta-agujas PROMEDUR	354
COLLIN Espéculos vaginales para niños y virgenes	107	DEBAKEY Separadores autoestáticos	321
COLLIN Espéculos vaginales, aislados para cirugía HF	112	DEBAKEY Tijeras para conducto biliar PROMEDUR	84
COLLIN Espéculos vaginales, aislados para cirugía HF	112	DEBAKEY-COLLIER Pinza hemostática	287
COLLIN Espéculos vaginales, antideslumbrante para cirugía LASER	112	DEBAKEY-DOYEN Pinzas intestinales	37
COLLIN Mangos de bisturi	202,205	DEBAKEY-HAYES Pinzas intestinales	39
COLLIN Pelvimetro	20,177	DEBAKEY-KOCHER Pinzas intestinales	38
COLLIN Pinza para curaciones	304	DEBAKEY-MICRO Clamps Bulldog atraumáticas	272
COLLIN Pinza para tejidos y organos	31	DEBAKEY-MICRO Pinzas vasculares	251
COLLIN Pinzas coger para el útero	140,141	DEBAKEY-SCUDDER Clamps intestinales	41
COLLIN Separadores abdominales	324	DEBAKEY-WERTHEIM Pinza para histerectomia	153
COLLIN-BABY Separador abdominal	324	Decapitación, instrumentos	186
COLLIN-DUVAL Pinzas intestinales	249	DEMARTELL Tijeras para conducto biliar	84
COLLIN-LOCKTITE Separador abdominal	325	DEMARTEL-WOLFSON Pinzas para anastomosis intestinales	46
COLLYER Pelvimetro	20,177	DENIS- BROWNE Pinzas intestinales	249
Contenedores para esterilización	376,378,380,382,384,390	DENIS-BROWN Separadores abdominales	331
Contenedores para esterilización Mini	382	Depresor uterino	131
Contenedores para esterilización para endoscopia	384	DESJARDINS Cucharillas para cálculos biliares	79
Contenedores para esterilización para instrumental microcirugia	390	DESJARDINS Exploradores para cálculos biliares	75
Contenedores para esterilización planos	382	DESJARDINS Pinzas para cálculos biliares	81
COOLEY Cánulas de aspiración	369,370	DEWEY Forceps obstétrico	183
COOLEY Pinzas vasculares	251	Diagnóstico	42186
COOLEY Pinzas vasculares TITANIO	251	Diagnóstico	195-198
Copas graduadas	392	DICK Pinzas de presión	148
COUPLAND Cánula de aspiración	367	DIETRICH Clamps Bulldog atraumáticas	271
CRAFOORD Pinzas hemostáticas	281	Dilatadores uterinos	128,129
CRAFOORD Tijeras quirúrgicas	221	Dinamómetro	19
CRAFOORD-SELLORS Pinzas hemostáticas	281	Dispensores de algodón	391
CRAFOORD-SELLORS Pinzas hemostáticas	289	Distribuidor de filtros	386
Craneoclastos	186	Distribuidores para cepillos	23
CRILE Pinzas hemostáticas	275	DIU instrumentos	132
CRILE Porta-agujas	359	DIU Pinzas para poner y para extracción	132
CRILE-BABY Pinzas hemostáticas	275	DOUAY Pinzas para biopsia uterina	157
CRILE-COLLER Pinzas hemostáticas	276	DOYEN Pinza para cálculos biliares	82
CRILE-MURRAY Porta-agujas	359	DOYEN Pinzas intestinales	33
CRILE-RANKIN Pinzas hemostáticas	276	DOYEN Separador	312
CRILE-WOOD Porta-agujas	359	DOYEN Separadores abdominales	336
CRILE-WOOD Porta-agujas PROMEDUR	353	DOYEN Separdores vaginales	125
CRILE-WOOD-BABY Porta-agujas PROMEDUR	353	DOYEN Sonda acanalada	366
Cuadros para fijar	377,379,381,383	DOYEN Tijeras para ginecologia	179
Cubetas	393	DOYEN Tira miomas	145
Cuchara para medicamentos	394	DOYEN-DEBAKEY Pinzas intestinales	37
Cucharillas para aborto	189	DOYEN-STILLE Separadores	312
Cucharillas para cálculos biliares	77,78,79	DUBOIS Tijeras para decapitación	180,186
Cucharillas uterinas	164,165	DUEHRSEN Pinza quirúrgica	245
Cuchillo para miomas	145	DUEHRSEN Pinzas de disección	238
Curetetas aspiradoras uterinas	170	DUNHILL Pinzas hemostáticas	275
Curetetas para biopsia uterina	162,163	DUPLEY Pinzas para cuello uterino	135
Curetetas uterinas	164-169	DUPLEY Pinzas porta-tampones	303
CUSCO Espéculos vaginales	111	DUPLEX DE LUXE Estetoscopio	12,198
CUSCO Espéculos vaginales Modelo suizo	110	DUPLEX Estetoscopio	12,198
CUSCO Espéculos vaginales, aislados para cirugía HF	111	DURANTE Pinzas quirúrgicas	248
CUSCO Espéculos vaginales, antideslumbrante para cirugía LASER	111	DUVAL Pinza para tejidos y organos PROMEDU	31
CUSHING Pinzas de disección PROMEDUR	253	DUVAL Pinzas intestinales atraumaticas	31
CUSHING Separador	317	DUVAL Pinzas para tejidos y organos	31
CUZZI Cucharillas para aborto	189	DUVAL Pinzas per afferare tessuti	249
CZERNY Espéculo rectal	47		

	Pagina		Pagina
E		Ginecología	105-173
EASTMAN Espéculos vaginales	123	GLASSMANN Pinzas atraumaticas	252
Elevador para cabeza	181	GLOVER Clamps Bulldog atraumáticas	269
ELLIOT Forceps obstétricos	182	GOELET Separador doble	307
EMMET Ganchos para fistulas	144	GOODELL Dilatador uterino	129
EMMET Pinza para curaciones	303	GOSSET Separadores abdominales	327
EPPENDORF Pinza para biopsia uterina	160	GOURDET Cucharillas uterinas	165
Esfinteroscopia	52	Grapas para fijar paños	388
Especulo abdominal autoestático	336	GRAVES Espéculos vaginales	113,114
Espéculos rectales	47-49	GRAVES Espéculos vaginales, aislados para cirugía HF	113
Espéculos vaginales	107-127	GRAVES Espéculos vaginales, antideslumbrante para cirugía LASER	113
Espéculos vaginales para niños y vírgenes	107-109,,118	GRAY Pinzas para cálculos biliares	80
Esterilización	373-395	GREEN Separador	310
Estetoscopios	12,198	GREEN-ARMYTAGE Pinzas uterinas	187
Estiletos con ojo	365	GREGORY Clamps Bulldog atraumáticas	270
Estiletos dobles abotonados	365	GREGORY Porta-agujas DIAMANTE	349
Estiletos mirtoform	366	GREGORY Porta-agujas PROMEDUR	349
Estiletos, Sondas	365	GROSS Pinzas para curaciones	303
Estómago, Intestinos, Recto	25-71	GROSS Pinzas para polipos	303
Estrijos para instrumentos	375	Guida-tampónes	131
Estuchos para agujas	391,392	GUNNAR-HEY Pinza para drenaje	299
Etiquetas indicadoras (esterilización)	385	GUTTMAN Cucharilla para secreción	103
EWALD Pinzas anatómicas	235	GUYON Bujias dilatadoras uretrales	104
EWALD Pinzas quirúrgicas	241	GUYON Mandril para sondas	102
EXACTA Tensiómetro	10,196	GUYON Pinzas renales	88,291,293
Exploradores para cálculos biliares	75	GWILLIAM Pinzas para histerectomia	150
Extractor-hojas de bisturi	205		
F		H	
FANSLER-IVES Anoscopio	53	HALSTED Pinzas hemostáticas	277
FANSLER-IVES Anoscopio con alumbrado frio	54	HALSTED-MOSQUITO Pinzas hemostáticas	274
FAURE Pinza para biopsia uterina	156	HARRINGTON Pinza de disección y ligaduras	292
FAURE Pinzas para peritoneo	147	HARRISON Pinzas para esterilización	374
FEHLAND-DEBAKEY Clamp intestinal	39	HARTMANN Pinzas hemostáticas	273
FERGUSON Tijeras para ginecología	179	HARTMANN-MICRO Pinzas hemostáticas	273
FERGUSSON Pinza de presión	43	HAYES-DEBAKEY Pinzas intestinales	39
FERRIS-SMITH Pinzas quirúrgicas	244	HEANEY (Hegar) Porta-agujas	361
FILTROS textil	387	HEANEY Pinzas para histerectomia	149
FILTROS, papel	386	HEANEY Porta-agujas PROMEDUR	356
FINOCHIETTO Porta-agujas	360	HEANEY-BALLENTINE Pinza para histerectomia	149
FINOCHIETTO Porta-agujas PROMEDUR	355	HEANEY-KANTER Pinza para histerectomia	149
FLETCHER Pinzas para curaciones	301	HEANEY-REZEK Pinzas para histerectomia	149
FOCUS Halogen-Lampara frontal 230 V.	15	HEGAR Dilatadores uterinos	128,129
FOERSTER P/esponj. 25 cm cur.est	83,300	HEISS Pinzas hemostáticas	278
FOERSTER Pinza para esponjas	293	HENROTIN Pinza para cuello uterino	137
FOERSTER Pinzas para curaciones	300,301	HERRICK Pinza rénale	88
FOERSTER Pinzas para vesícula biliar	83,300	HERTZLER Separador abdominal	328
FOERSTER Separador abdominal plástico, transparente a los rayos-X	337	HEYWOOD-SMITH Pinza hemorroïdal	70
Fórceps obstétricos	181-184	HEYWOOD-SMITH Pinzas para polipos	83,142,190
FORD-DIXON Ligador para hemorroïdes	66	HILL-FERGUSON Espéculos rectales	47
FRANKLIN-SILVERMAN Cánulas para biopsia	87	HIRSCHMANN Anoscopios	52
FRITSCH Separadores	313	Histerómetros	130
FUCHSIG Pinza hemostática	278	Histero-Salpingografía	171
G		HOESEL Separadores rectales	61
Gancho para decapitación	186	Hojas de bisturi	200,203
Gancho para extracción DIU	132	Hojas de Microbisturi	199
Ganchos para cordón espermático	99	HOLZBACH Separador abdominal	326
Ganchos para fistulas	144	HORGAN valva central para separadores	330
GAUSS Pinza para pericráneo	187	HRYNTSCHAK Separador vesical	101
GELPI Separadores autoestáticos	322,323	HULKA Pinza para cuello uterino	135
GELPI-BABY Separador autoestático	322	HULKA-KENWICK Pinza para cuello uterino	135
GELPI-MINI Separador autoestático	322		
GELPI-SELETZ Separador autoestático	323	I	
GEMINI Pinzas de disección y ligaduras	284	Instrumento para circuncisión	103
GEMINI Pinzas hemostáticas	293,291	Instrumentos de aspiración	367-370
GEMINI-MINI Pinzas de disección y ligaduras	284	Instrumentos Generales	195-371
GERALD Pinzas de disección PROMEDUR	254	Instrumentos para amnioscopia	172
GERALD Pinzas quirúrgicas	244	Instrumentos para introducir catéteres	102
GILLIES Pinza de disección	242	IOWA Cánula para anestesia transvaginal	188
GILLIES Pinza de disección PROMEDUR	254	IOWA Guía-agujas	188
GIL-VERNET Separadores para venas y hilares	91	IOWA Pinza rompe-membrana	188
		ISRAEL Separadores	309

	Pagina		Pagina
J			
JACKSON Espécúlos vaginales	123	LITTLEWOOD Pinza para tejidos y organos	28
JACKSON-BURROWS Separador autoestático	323	Llmparas frontales	15
JACOBS Pinzas para cuello uterino	138	LLOYD-DAVIS Pinzas para anastomosis rectales	43
JACOBSON-MICRO Pinzas hemostáticas	274	LLOYD-DAVIS Tijera para recto	59,223
JARCHO Pinza para cuello uterino	134	LOCKHART-MUMMERY Sondas para fistulas	63,366
JEFFERSON Pinza de disección	242	LOCKWOOD Pinza intestinal	29
JEFFERSON Pinzas anatómicas	236	LORNA Pinzas de campo	298
JOERGENSON Tijeras para preparaciones	217	LOWER Pinza para conducto pililar	80
JOHN-HOPKINS Pinza para conducto biliar	80	LUER-KOERTE Cucharillas para cálculos biliares	78
JOHNSON Porta-agujas	360	LUIKART Forceps obstétrico	182
JOLL (Friedmann) Separador para retención	126,321	LUIKART-BILL Tractor	184
JONES Pinzas de campo	297	Lupas frontales binoculares	13
JUDD-ALLIS Pinzas para tejidos y organos	28	LURZ Pinzas para uretère	96
JUDD-MASON Separador vesical	100	Luz fria, proyector hanógeno	57
JUDD-MASON Separador vesical	101		
Juego de manicura para enfermeras	23		
K			
KALLMORGEN Espécúlos vaginales	122	MAIER Pinzas para curaciones	303
KANE Clamp para cordon ombilical	185	MAINGOT Pinzas para histerectomia	150
KANTROWITZ Pinzas de disección y ligaduras	284	Mangos de bisturi	201-203,206-206
KELLY Esfinteroscopio	52	Mangos de bisturi PRO-MEDSEKUR™	202
KELLY Pinza para aborto	191	Mangos de Microbisturi	199
KELLY Pinza para polipos	142,190	Mangos para anoscopios, proctoscopios	55
KELLY Pinzas hemostáticas	275	Mangos para Pinzas para biopsia uterina	159
KELLY Proctoscopios	52	Mano izquierda, Tijeras	214,215
KELLY Separadores	311	MARBERGER Separadores para venas y hilares	91
KELLY Separadores para el higado	85,311	MARINUS Clamps intestinales	42
KELLY-RANKIN Pinzas hemostáticas	276	MARTEL Pinza para pericráneo	187
KERSTING Clamp intestinal	40	MARTIN Histerómetro malleable	130
KEVORKIAN Curetas para biopsia	162	MARTIN Pelvimetro	20,177
KEVORKIAN Pinza para biopsia uterina	161	MARTIN Pinza para desechos	374
KEVORKIAN-PACIFIC Pinza para biopsia uterina	158	MASSON Porta-agujas	361
KIELLAND Forceps obstétrico	181	MASSON Porta-agujas PROMEDUR	356
KIELLAND-LUIKART Forceps obstétrico	182	MATHIEU Espécúlo rectal	49
KIRSCHNER Separadores abdominales	332	MATHIEU Pinzas para cuerpos extraños	103
KLEINSCHMIDT Pinza para apendectomia	45	MATHIEU Porta-agujas PROMEDUR	358
KLING-EX Extractor-hojas	205	MATHIEU-KOCHER Porta-agujas PROMEDUR	358
KLINIK.BERLIN Pinza cierra-tubos	299	MAYO Clavijas de esterilización	375
KOCHER Pinzas intestinales	34	MAYO Cucharillas para cálculos biliares	77
KOCHER Separador prostático	97	MAYO Tijeras para preparaciones	216
KOCHER-BABY Pinzas intestinales	33	MAYO Tijeras para preparaciones PROMEDUR	222
KOCHER-DEBAKEY Pinzas intestinales	38	MAYO Tijeras para preparaciones SUPER CUT	216
KOCHER-WAGNER Separadores	313	MAYO-ADAMS Separador autoestático	325
KOERTE Separadores	308	MAYO-BLAKE Pinzas para cálculos biliares	82
KOGAN Endospécúlos	127	MAYO-GUYON Pinza rênale	88
KONRICH Tambores de esterilización	390	MAYO-HARRINGTON Tijeras para preparaciones	217
KRISTELLER Espécúlos vaginales	118-121	MAYO-HARRINGTON Tijeras para preparaciones PROMEDUR	224
KRISTELLER Espécúlos vaginales para niños y vírgenes	108	MAYO-HEGAR Porta-agujas	359
KÜSTNER Pinza uterina	139	MAYO-HEGAR Porta-agujas PROMEDUR	354
		MAYO-LEXER Tijeras para preparaciones	217
		MAYO-LEXER Tijeras para preparaciones PROMEDUR	224
		MAYO-LEXER Tijeras para preparaciones SUPER CUT	217
		MAYO-NOBLE Tijeras para preparaciones	217
		MAYO-ROBSON Pinzas intestinales	35
		MAYO-RUSSIAN Pinza de diseccion	247
		MAYO-STILLE Tijeras para preparaciones	216
		MAYO-STILLE Tijeras para preparaciones SUPER CUT	216
		McGIVNEY Ligadores para hemmorroides	65,69
		McGIVNEY Pinzas para aggarar hemmorroides	70
		McINDOE Pinza anatómica PROMEDUR	254
		McLEAN Forceps obstétrico	183
		McLEAN-TUCKER Forceps obstétrique	183
		MEEKER Pinzas de disección y ligaduras	285
		MENGHINI Cánulas para biopsia del higado	87
		METZENBAUM Porta-agujas	360
		METZENBAUM Tijeras para preparaciones	219,220,221
		METZENBAUM Tijeras para preparaciones PROMEDUR	222,226-227
		METZENBAUM Tijeras para preparaciones SUPER CUT	219
		METZENBAUM-BABY Tijeras para preparaciones	218
		METZENBAUM-FINO Tijeras para preparaciones	220
		METZENBAUM-FINO Tijeras para preparaciones PROMEDUR	227
		MICRO-ADSON Pinzas anatómicas	235
		MICRO-ADSON Pinzas quirúrgicas	241
		MICRO-DEBAKEY Clamps Bulldog atraumáticas	272
		MICRO-DEBAKEY Pinzas vasculares	251
		MICRO-JACOBSON Pinzas hemostáticas	274
L			
LAHEY Pinzas para conducto biliar	79		
LAHEY Separador	309		
LANDAU Separdores vaginales	124		
LANDOLD Mangos de Microbisturi	199		
LANE Pinzas de campo	298		
LANE Pinzas quirúrgicas	247		
LANGENBECK Porta-agujas PROMEDUR	355		
LANG-STEVENSON Pinza intestinales	33		
LATERAL Separador vaginal	127		
LAWRENCE Pinza de disección y ligaduras	285		
LEGUEU Separador vesical	97		
LEGUEU Separador vesical autostatico	325		
LERCHE Pinzas quirúrgicas	246		
LEXER-BABY Tijeras para preparaciones	218		
LICHTENBERG Porta-agujas PROMEDUR	358		
LICHTWITZ Trocar	371		
Ligadores para hemmorroides	65-69		
Limas de uñas	23		
LISTER-SINUS Pinzas para senus	302		
LITTAUER Pinzas corta-uñas	22		
LITTLE Separador	309		

	Pagina		Pagina
MICRO-MOSQUITO Pinzas hemostáticas	274	PEDERSON Espéculos vaginales, antideslumbrante para cirugía LASER114	
Micro-Tijeras	209-213	PEERS Pinza de campo para paños de papel	297
Micro-Tijeras coronarias	210	PELKMANN Pinzas para curaciones	302
Micro-Tijeras para Ginecología	211	Pelvímetros	20,177
MICRO-VASCULAR Porta-agujas PROMEDUR	353	PENNINGTON Pinza para tejidos y órganos	27
MIDDELDORF Separadores	310	Perforadores-cráneo	186
MIKULICZ Pinzas para peritoneo	146	PESTALOZZA Cucharilla para aborto	189
MIKULICZ Separadores para el hígado	85	PETRI cubeta	392
MIKULICZ-BABY Pinza para peritoneo	146	PHANEUF Pinzas para peritoneo	148
MILLER Tijera para recto	58	PINARD Estetoscopios	12,198
MILLIN Pinzas para prostatectomía	95	Piñons para fijar instrumentos	389
MILLIN Separador para prostatectomía	100	Piñons para fijar separadores	389
MILLIN Separadore para cuello vesical	96,100	Pinza para abrir botellas de infusión	375
MILLS Tijeras para aconducto biliar	84	Pinza para apendectomía	45
MINIMUS II Tensiómetro	10,196	Pinza para cordón espermático	96
MIXTER Pinza para cálculos biliares	80,82	Pinza para Microbiopsia uterina	161
MIXTER Pinzas de disección y ligaduras	286	Pinza para pene	103
MIXTER-BABY Pinzas de disección y ligaduras	285	Pinza para útero	90,141
MIXTER-O'SHAUGHNESSY Pinzas hemostáticas	283	Pinza rompe-membrana	188
MOGEN Instrumento para circuncisión	103	Pinza-abrir botellas de infusión	375
MOORE Cucharilla para cálculos biliares	77	Pinzas anatómicas, quirúrgicas, etc.	234-266
MORGAN Proctoscopio	53	Pinzas atraumáticas	250-252
MORRIS Separadores	312	Pinzas bipolares	257-265
MORRIS Separadores dobles	307	Pinzas cierra-tubos	299
MORRIS-MITRAL Separador autoestático	323	Pinzas cierra-tubos con estribo de protección	299
MOSQUITO Pinzas hemostáticas	274	Pinzas corta-uñas	22
MOYNIHAN Cucharillas para cálculos biliares	79	Pinzas de campo	297-298
MOYNIHAN Explorador para cálculos biliares	75	Pinzas de disección	237
MOYNIHAN Pinza de campo	298	Pinzas de disección FINO	237
MÜNCHEN Curetas para biopsia uterina	163	Pinzas de disección PROMEDUR	253-256
MURLESS Elevador para cabeza	181	Pinzas de disección USA-MODEL	237
MUSEUX Pinzas para cuello uterino	139	Pinzas de disección y ligaduras	277-286
		Pinzas de presión	43,148
N		Pinzas hemostáticas	273-281
NAEGELE Forceps obstétrico	181	Pinzas hemostáticas y para preparaciones	269-293
NAEGELE Perforador-cráneo	186	Pinzas intestinales	33-46,279
NAGEL Micro-Tijeras	213	Pinzas intestinales para píloro	44
NAUNTON-MORGAN Porta-agujas PROMEDUR	357	Pinzas para aborto	190,191
NEIVERT Porta-agujas	359	Pinzas para agarrar hemorroides	70
NEIVERT Porta-agujas PROMEDUR	353	Pinzas para anastomosis intestinales	46
NELATON Sonda acanalada	366	Pinzas para anastomosis rectales	44
NELSON Pinzas per afferare tessuti	246	Pinzas para biopsia rectal	71
NELSON Trocares	371	Pinzas para biopsia uterina	155-161
NISSEN Pinza hemostática	278	Pinzas para cálculos biliares	81-82
NONSTICK Pinzas bipolares	257-260	Pinzas para cálculos renales	89
NOTO Pinza para polipos uterinos	143,190	Pinzas para coger el útero	141
NOVAK Curetas para biopsia uterina	163	Pinzas para conducto biliar	79-80
NOVA-PRESAMETER Tensiómetro	9,195	Pinzas para cuello uterino	133-138
NUSSBAUM Pinzas intestinales	36	Pinzas para cuerpos extraños	103
		Pinzas para curaciones	300-304
O		Pinzas para desechos	374
Obstetrica	175-191	Pinzas para drenaje	299
OCHSNER Trocares	371	Pinzas para esterilización	374
OCULUS Lupas frontales	13	Pinzas para histerectomía	149-154
OEHLER Pinza de disección PROMEDUR	255	Pinzas para pericráneo	187
Olío para el mantenimiento de instrumentos	391	Pinzas para peritoneo	146-148
OLLIER Separadores	308	Pinzas para polipos	303
OLVECRONA Pinzas hemostáticas	281	Pinzas para polipos uterinos	142,143
OMBREDANNE Pinza de campo	297	Pinzas para prostatectomía	95
OMBREDANNE Pinza intestinale	29	Pinzas para senus	302
O'SULLIVAN-O'CONNOR Separador abdominal	334	Pinzas para tejidos y órganos	27-32
OVERHOLT-BABY Pinza hemostatática	283	Pinzas para uréter	90,96
OVERHOLT-GEISSENDOERFER Pinzas hemostáticas	283	Pinzas para vasectomía	99
OVERHOLT-MIXTER Pinzas hemostáticas	283	Pinzas para vendajes con tapa	393
		Pinzas per afferare tessuti	240,246,247,249
P		Pinzas porta-tampones	300-304
Paños de esterilización	387	Pinzas quirúrgicas	239-243
PARAMETRIUM Tijeras PROMEDUR	60,225	Pinzas quirúrgicas USA Model	243
PARKS Espéculo rectal para adaptador luz fría	50	Pinzas renales	88
PAYR-BABY Pinza intestinale para píloro	44	Pinzas vasculares	250-252
PEAN Pinzas hemostáticas	279	Pinzas-Clamps para transplantar del hígado	86
PEAN-FINO Pinzas hemostáticas	280	Pinzas-Tijeras bipolares	231
PEDERSON Espéculos vaginales	107,114	PIPER Forceps obstétrico	182,184
PEDERSON Espéculos vaginales, aislados para cirugía HF	114	PITTSBURG Clamps para transplantar del hígado	86
		Placas de identificación (esterilización)	385
		POOLE Cánulas de aspiración	368,37

	Pagina		Pagina
Porta-agujas	345-361	SCHULZE-BERGMANN Espéculo rectal	48
Porta-agujas micro	345-352,353	SCHUMACHER Pinzas para biopsia uterina	160
Porta-agujas micro von mango "PERFIL"	352	SCHUMACHER Tijera umbilicales	179
Porta-agujas PROMEDUR	345,347-349,353-358	SCHUMACHER-VAN DOREN Pinza para biopsia	155
Porta-agujas TITANIO	350,351,352	SCUDDER Pinzas intestinales	35
Porta-aldodones para rectoscopios	64	SCUDDER-DEBAKEY Clamps intestinales	41
Porta-Micro-instrumentos	389	SEGOND Bisturi para fibromas	145
POTTS-DE-MARTEL Tijeras para aconducto biliar	84	SEGOND Pinza para histerectomia	149
POTTS-SMITH Pinzas de disección	238	SEGOND-LANDAU Pinza para histerectomia	149
POTTS-SMITH Pinzas de disección PROMEDUR	253	SELLHEIM Elevador obstetrico	184
POTTS-SMITH Pinzas quirúrgicas	245	SEMKEN Pinzas anatómicas	236
POTTS-SMITH Tijeras para aconducto biliar PROMEDUR	84	SEMKEN Pinzas quirúrgicas	242
POZZI Pinzas para cuello uterino	134	SEMM Espéculos vaginales	115
PRATT Espéculo rectal	49	SEMM Separadores abdominales	333
PRATT Pinzas para cuello uterino	137	Separador abdominal plástico, transparente a los rayos-X	337
PRATT-"T" Pinza para tejidos y organos	32	Separador para perinea	51
Precintos de seguridad	385	Separador para píloro	44
PRECISA I Tensiómetro	9,195	Separador vesical	325
PRESBYTERIAN Pinzas cierra-tubos	299	Separadore para cuello vesical	96
Proctoscopios	52	Separadores	307-341
PRO-MEDSEKUR™ Mangos de bisturi	201	Separadores abdominales	324-341
PROVIDENCE-HOSPITAL Pinzas hemostáticas	275	Separadores autoestáticos	321-341
Proyector halógeno de luz fria	15,57	Separadores dobles	307,310
		Separadores endocervicales	127
		Separadores para contenedores	389
		Separadores para el higado	85
		Separadores para pelvis	63
		Separadores para venas y hilares	91,92
		Separadores prostáticos	98
		Separadores rectales	61,62
		Separadores vesicales	100-101
		Separadores vaginales	124,125
		SEYFFERT Espéculos vaginales	115
		SIEBOLD Tijeras para ginecologia	179
		SIMON Cucharillas uterinas	164
		SIMON Ganchos para fistulas	144
		SIMON Separdores vaginales	125
		SIMPSON Forceps obstétrico	181
		SIMPSON-BRAUN Forceps obstétrico	182
		SIMPSON-LUIKART Forceps obstétrico	182
		SIMS Curetas uterinas	166
		SIMS Depresor uterino	131
		SIMS Espéculo rectal	48
		SIMS Espéculos vaginales	123
		SIMS Histerómetros	130
		SIMS Tijeras para ginecologia	178
		SIMS Tijeras quirúrgicas PROMEDUR	224
		SIMS-MAIER Pinzas para curaciones	302
		SINGLEY (TUTTLE) Pinzas per afferare tessuti	240,247
		SKENE Pinza para cuello uterino	136
		SMELLIE Gancho obstétrico	185
		SMELLIE Perforador-cráneo	186
		SOFIELD Separadores	307
		SOMER Pinza para el útero	140
		Sondas acanaladas	366
		Sondas acanaladas abotonadas	366
		Sondas metalicas p.hombres y mujeres	102
		Sondas para conducto biliares	76
		Sondas para fistulas	63,366
		Sondas, Estiletos	365
		SPENCER-WELLS Pinzas hemostáticas	279
		ST.MARKS Proctoscopio	52
		St.MARKS Separador para perinea	51
		St.MARKS Separadores para pelvis	62
		STAUDE-MOORE Pinza para cuello uterino	133
		STELZNER Tijeras para recto	59,223
		STILLE Pinza renal	88
		STILLE Pinzas de disección	237
		STILLE-BARRAYA Pinzas quirúrgicas	248
		STINGER Estribos para instrumentos	375
		STOCKMANN Pinza para pene	103
		STONE Pinza quirúrgica	246
		STRATTE Porta-agujas	361
		STRATTE Porta-agujas PROMEDUR	357
		STRAUSS F/O Rectoscopio completo	57
		STRAUSS Pinza para pene	103

R

RAMATHIBODI Gancho tubular	132
RAMATHIBODI Manipulador uterino	132
RAMPLEY Pinzas para curaciones	301
RAMSAY Pinzas anatómicas	238
RAMSAY Pinzas quirúrgicas	245
RANDALL Cureta para biopsia uterina	163
RANDALL Pinzas para cálculos renales	89
RANKIN-CRILE Pinzas hemostáticas	276
RANKIN-KELLY Pinzas hemostáticas	276
RECAMIER Curetas uterinas	167
Recipientes de algodón	391
Reglas	19
RESANO Clamp intestinal	40
RICARD Separador abdominal	326
RICHARDSON Separadores	310
RICHARDSON-EASTMAN Separadores dobles	310
Riñoneras	393
ROBERTS Pinzas hemostáticas	280
ROBIN-MASSE Separador abdominal	327
ROCHARD Dispositivos	335
ROCHARD Separadores abdominales	335
ROCHESTER-CARMALT Pinzas hemostáticas	279
ROCHESTER-OCHSNER Pinzas hemostáticas	282,290
ROCHESTER-PEAN Pinzas hemostáticas	280,288
ROEDER Pinzas de campo	298
ROGGE Pinzas para esterilización	374
ROTOCRETA Cureta para biopsia uterina	162
RUDD Ligador hemmoroidal	65
RUMEL Pinzas de disección y ligaduras	284
RUSSIAN Pinzas de disección	247
RUSSIAN Pinze per afferare tessuti	239

S

SAENGER Pinzas para aborto	191
SALING amnioscopios	172
Salpingografía	171
SANTULLI Clamp Bulldog atraumática	271
SAROT Pinza hemostatática	289
SAROT Porta-agujas	361
SAROT Porta-agujas PROMEDUR	357
SAUERBRUCH Estucho para agujas	392
SAUERBRUCH pinza para desechos	374
SCHAEDEL Pinza de campo	297
SCHERBAK Espéculos vaginales	117
SCHIMMELBUSCH Tambores de esterilización	390
SCHROEDER Cucharillas uterinas	164
SCHROEDER Pinzas para cuello uterino	134,136
SCHUBERT Pinzas para biopsia uterina	156
SCHULTZE Salpingógrafo	171

	Página
STRINGER estribos para instrumentos	375
Sujetafiltros	386
Sutura	345-361

T

Tabiques	377,379,381
Tambores de esterilización	390
Tapas de seguridad para contenedores	376,378,380
Tapices portas instrumentos de silicona	387
TARNIER Basiotribo	186
TARNIER Forceps obstétrico	183
Tarros	394
TAYLOR Pinzas quirúrgicas	245
TAYLOR-CUSHING Pinzas quirúrgicas	245
TEALE Pinzas para cuello uterino	138
Tensiómetros	9-11,195-197
THOMAS Curetas uterinas	165
THOMS-ALLIS Pinza para tejidos y organos	28
THOMS-GAYLOR Pinza p. biopsia 24cm	155
THOMSON-WALKER Separador vesical	101
THOREK Tijeras para vesícula biliar	218
TIEMANN Pinza para cuello uterino	136
TIJERA corta-uñas	22
Tijeras	209-231
Tijeras bipolares	228-230
Tijeras finas	214
Tijeras finas para ZURDOS	214
Tijeras finas SUPERCUT	214
Tijeras para conducto biliar	84
Tijeras para decapitación	180,186
Tijeras para enterotomía	58
Tijeras para episiotomía	180
Tijeras para ginecología	178-180
Tijeras para perineo	180
Tijeras para preparaciones	216-222
Tijeras para recto	59,223
Tijeras para vesícula biliar	218
Tijeras quirúrgicas	215
Tijeras quirúrgicas para ZURDOS	214,215
Tijeras umbilicales	179
Tijeras.cuticulares	22
Tijeras-Pinzas bipolares	231
Tira miomas	145
Tiras de protección	388
TISCHLER (Baggish) Pinza para biopsia uterina	158
TISCHLER Pinza para biopsia uterina	158
TISCHLER-BURKE Pinza para biopsia uterina	158,159
TISCHLER-KEVORKIAN Pinza para biopsia uterina	158
TISCHLER-MINI Pinza para biopsia uterina	158
TOHOKU Pinzas de campo	298
TOWNSEND Curetas para biopsia uterina	162
TOWNSEND Mango suelto	159
TOWNSEND-KERVORKIAN Pinza para biopsia uterina	159
TOWNSEND-KRAUSE Pinza para biopsia uterina	159
TOWNSEND-MINI Pinzas para biopsia uterina	159
TOWNSEND-TISCHLER Pinzas para biopsia uterina	159
Transformador 220 V, 1 A	14
TRELAT Espéculos vaginales	115
TREVES Pinzas quirúrgicas	246
Trocares	371
TUEBINGEN Separador	313
TUFFIER Pinza para tejidos y organos	27
TURNBULL Pinzas corta-uñas	22
TURNER-WARWICK Separador abdominal	338-340

U

ULRICH Pinzas porta-tampones	303
UNIVERSAL Trocares	371
URO Pinzas para uréter	90
Urología	93-104
USA-MODELO Pinzas cierra-tubos	299

V

Vaginoscopio con iluminación	173
Vaginoscopio para niños y vírgenes	109,173
VALLEIX Histerómetro	130
VAN BUREN Bujías dilatadoras uretrales	104
VAN DOREN Pinza p. biopsia 25 cm	155
VANNAS Micro-Tijeras	209,212
Vasectomía	99
Vasos para medicamentos	394

W

WALDMANN Tijeras para episiotomía	180
WALLICH Cucharilla para aborto	189
WALTON Pinzas para curaciones	302
WANGENSTEEN Pinzas de disección PROMEDUR	253
WANGENSTEEN Pinzas per afferare tessuti	247
WANGENSTEEN Porta-agujas	361
WANGENSTEEN Porta-agujas PROMEDUR	356
WASSMUND Separador	308
WAUGH Pinzas quirúrgicas	248
WEISSBARTH Espéculo vaginal	118
WERTHEIM Pinza para peritoneo	146
WERTHEIM Pinzas para histerectomía	149,152
WERTHEIM Tijeras quirúrgicas	218
WERTHEIM-ATRAUMA Pinza para histerectomía	151
WERTHEIM-CULLEN Pinza para histerectomía	151
WERTHEIM-DEBAKEY Pinzas para histerectomía	153
WIJNEN Tubo de aspiración	368,370
WIKSTROEM Pinza de disección y ligaduras	285
WILLET Pinza para pericráneo	187
WILLIAMS Pinza para tejidos y organos	29
WINTER Pinzas para aborto	191
WITTNER Pinzas para biopsia uterina	160
WRIGLEY Forceps obstétrico	181

Y

YANKAUER Cánulas de aspiración	367
YEOMAN Pinzas para biopsia rectal	71
YOUNG Pinza para prostatectomía	95
YOUNG Separadores prostáticos	98

Z

Z-HISTEREKTOMIA Pinzas para histerectomía	154
ZIEGLER Espejo frontal	14
ZURDOS, Tijeras	214,215

NUMMERNVERZEICHNIS · NUMMERICAL INDEX · INDEX DES NUMEROS · INDICE NUMERIO · INDICE NUMERIO

Kat.Nr. Cat.No. No. Réf. No. Ref. No. Cat.	Seite Page Page Página Pagina	Kat.Nr. Cat.No. No. Réf. No. Ref. No. Cat.	Seite Page Page Página Pagina	Kat.Nr. Cat.No. No. Réf. No. Ref. No. Cat.	Seite Page Page Página Pagina	Kat.Nr. Cat.No. No. Réf. No. Ref. No. Cat.	Seite Page Page Página Pagina
10...		12.0062S	199	13.0309SC	215	13.0434	216
10.0010	9,195	12.0065	199	13.0310	215	13.0434SC	216
10.0020	9,195	12.0067	199	13.0311	215	13.0435	216
10.0030	10,196	12.0069	199	13.0312	215	13.0435SC	216
10.0040	10,196	12.0070	205	13.0313	215	13.0436	216
10.0080	11,197	12.0101	202	13.0330	215	13.0437	216
10.0081	11,197	12.0102	204	13.0330SC	215	13.0438	216
10.0082	11,197	12.0103	202	13.0331	215	13.0439	216
10.0083	11,197	12.0104	204	13.0332	215	13.0440	217
10.0084	11,197	12.0105	204	13.0333	215	13.0440SC	217
10.0085	11,197	12.0106	202	13.0333SC	215	13.0441	217
10.0090	11,197	12.0107	202	13.0334	215	13.0441SC	217
10.0091	11,197	12.0108	202	13.0334SC	215	13.0462	217
10.0092	11,197	12.0109	204	13.0335	215	13.0463	217
10.0094	11,197	12.0113	202	13.0335SC	215	13.0551	217
10.0095	11,197	12.0114	205	13.0336	215	13.0554	217
10.0300	19	12.0115	203	13.0337	215	13.0554SC	217
10.0331	19	12.0117	205	13.0338	215	13.0555	217
10.0332	19	12.0123	203	13.0339	215	13.0555SC	217
10.0333	19	12.0125	202	13.0340	215	13.0561	218
10.0334	19	12.0127	202	13.0341	215	13.0562	218
10.0335	19	12.0133	203	13.0342	215	13.0563	218
10.0350	19	12.0153	199	13.0343	215	13.0565	218
10.0352	19	12.0157	199	13.0350	215	13.0567	218
10.0400	12,198	12.0163	203	13.0351	215	13.0594	218
10.0410	12,198	12.0173	203	13.0352	215	13.0594SC	218
10.0460	12,198	12.0174	205	13.0352SC	215	13.0595	218
10.0462	12,198	12.0180	199	13.0353	215	13.0595SC	218
10.0700	14	12.0182	199	13.0353SC	215	13.0596	218
10.0707	14	12.0184	199	13.0354	215	13.0597	218
10.0709	14	12.0186	199	13.0354SC	215	13.0598	218
10.0730	14	12.0188	199	13.0355	215	13.0598SC	218
10.0731	14	12.0193	201	13.0355SC	215	13.0599	218
10.0737	14	12.0194	201	13.0356	215	13.0599SC	218
10.0739	14			13.0357	215	13.0602	219
10.0750	14			13.0358	215	13.0602SC	219
10.0760	15	13...		13.0358SC	215	13.0603	219
10.0761	15	13.0010	214	13.0359	215	13.0603SC	219
10.0762	15	13.0010SC	214	13.0360	215	13.0604	219
10.0763	15	13.0011	214	13.0360SC	215	13.0604SC	219
10.0769	15	13.0011SC	214	13.0361	215	13.0605	219
10.0790	15	13.0012	214	13.0362	215	13.0605SC	219
10.2000	15,57	13.0012L	214	13.0363	215	13.0606	219
		13.0012LSC	214	13.0363SC	215	13.0606SC	219
		13.0012SC	214	13.0394	215	13.0607	219
		13.0013	214	13.0400	216	13.0607SC	219
		13.0013L	214	13.0400SC	216	13.0608	219
		13.0013LSC	214	13.0401	216	13.0608SC	219
		13.0013SC	214	13.0401SC	216	13.0609	219
		13.0014	214	13.0402	216	13.0609SC	219
		13.0014SC	214	13.0402SC	216	13.0610	219
		13.0015	214	13.0403	216	13.0610SC	219
		13.0015SC	214	13.0403L	216	13.0611	219
		13.0022	214	13.0403SC	216	13.0611SC	219
		13.0023	214	13.0404	216	13.0612	219
		13.0300	215	13.0404L	216	13.0612SC	219
		13.0301	215	13.0404SC	216	13.0613	219
		13.0301SC	215	13.0405	216	13.0613SC	219
		13.0302	215	13.0405SC	216	13.0614	221
		13.0302SC	215	13.0406	216	13.0615	221
		13.0303	215	13.0406SC	216	13.0622	219
		13.0303SC	215	13.0407	216	13.0623	219
		13.0304	215	13.0407SC	216	13.0624	219
		13.0304L	215	13.0408	216	13.0625	219
		13.0304SC	215	13.0408SC	216	13.0626	219
		13.0305	215	13.0409	216	13.0627	219
		13.0305SC	215	13.0409SC	216	13.0628	219
		13.0306	215	13.0432	216	13.0629	219
		13.0307	215	13.0432SC	216	13.0630	219
		13.0308	215	13.0433	216	13.0631	219
		13.0308SC	215	13.0433SC	216	13.0642	219
		13.0309	215				

Kat.Nr. Cat.No. No. Réf. No. Ref. No. Cat.	Seite Page Page Página Pagina	Kat.Nr. Cat.No. No. Réf. No. Ref. No. Cat.	Seite Page Page Página Pagina	Kat.Nr. Cat.No. No. Réf. No. Ref. No. Cat.	Seite Page Page Página Pagina	Kat.Nr. Cat.No. No. Réf. No. Ref. No. Cat.	Seite Page Page Página Pagina
13.0643.....	219	13.2160.....	179	13.8120.....	232	14.0187.....	237
13.0644.....	219	13.2161.....	179	13.8130.....	232	14.0188.....	237
13.0644SC.....	219	13.2170.....	58	13.8304.....	231	14.0189.....	237
13.0645.....	219	13.2172.....	58	13.8305.....	231	14.0202.....	237
13.0645SC.....	219	13.2174.....	58	13.8310.....	231	14.0204.....	237
13.0646.....	219	13.2181.....	58	13.8311.....	231	14.0207.....	237
13.0647.....	219	13.2183.....	59,223	13.8400.....	232	14.0220.....	237
13.0648.....	219	13.2186.....	59,223	13.8410.....	232	14.0300.....	237
13.0649.....	219	13.2187.....	59,223	13.8420.....	232	14.0301.....	237
13.0650.....	219	13.2189.....	59,223	13.8430.....	232	14.0330.....	238
13.0650SC.....	219	13.2200.....	180			14.0340.....	238
13.0651.....	219	13.2202.....	180	14...		14.0350.....	238
13.0651SC.....	219	13.2210.....	179	14.0026.....	235	14.0352.....	238
13.0660.....	220	13.2220.....	179	14.0028.....	235	14.0354.....	238
13.0660SC.....	220	13.2232.....	179	14.0030.....	235	14.0390.....	238
13.0661.....	220	13.2240.....	180	14.0032.....	235	14.0526.....	241
13.0661SC.....	220	13.2240SC.....	180	14.0040.....	235	14.0527.....	241
13.0662.....	220	13.2244.....	180	14.0042.....	235	14.0528.....	241
13.0662SC.....	220	13.2246.....	180	14.0044.....	236	14.0530.....	241
13.0663.....	220	13.5208.....	222	14.0049.....	235	14.0532.....	241
13.0663SC.....	220	13.5209.....	222	14.0050.....	235	14.0540.....	241
13.0664.....	220	13.5220.....	224	14.0056.....	236	14.0541.....	241
13.0664SC.....	220	13.5221.....	224	14.0060.....	236	14.0542.....	241
13.0665.....	220	13.5222.....	224	14.0061.....	236	14.0543.....	241
13.0665SC.....	220	13.5223.....	224	14.0062.....	236	14.0545.....	241
13.0666.....	220	13.5240.....	224	14.0063.....	236	14.0546.....	235
13.0666SC.....	220	13.5241.....	224	14.0070.....	236	14.0547.....	235
13.0667.....	220	13.5242.....	224	14.0100.....	237	14.0548.....	242
13.0667SC.....	220	13.5243.....	224	14.0101.....	237	14.0549.....	241
13.0670.....	220	13.5248.....	224	14.0102.....	237	14.0550.....	242
13.0671.....	220	13.5249.....	224	14.0103.....	237	14.0554.....	242
13.0672.....	220	13.5250.....	224	14.0104.....	237	14.0556.....	242
13.0673.....	220	13.5251.....	224	14.0105.....	237	14.0560.....	242
13.0674.....	220	13.5255.....	60,225	14.0107.....	237	14.0561.....	242
13.0675.....	220	13.5259.....	60,225	14.0108.....	237	14.0562.....	242
13.0676.....	220	13.5281.....	60,225	14.0109.....	237	14.0563.....	242
13.0677.....	220	13.5310.....	226	14.0110.....	237	14.0566.....	242
13.0683.....	220	13.5311.....	226	14.0111.....	237	14.0570.....	242
13.0685.....	220	13.5313.....	227	14.0112.....	237	14.0600.....	243
13.0687.....	220	13.5317.....	227	14.0113.....	237	14.0601.....	243
13.0693.....	220	13.5320.....	226	14.0114.....	237	14.0602.....	243
13.0695.....	220	13.5321.....	226	14.0115.....	237	14.0603.....	243
13.0697.....	220	13.5323.....	227	14.0116.....	237	14.0604.....	243
13.0700.....	218	13.5327.....	227	14.0117.....	237	14.0605.....	243
13.0701.....	218	13.5330.....	226	14.0118.....	237	14.0607.....	243
13.1083.....	221	13.5331.....	226	14.0119.....	237	14.0608.....	243
13.1180.....	84	13.5333.....	227	14.0120.....	237	14.0609.....	243
13.1182.....	84	13.5337.....	227	14.0121.....	237	14.0620.....	243
13.1190.....	84	13.5360.....	226	14.0122.....	237	14.0621.....	243
13.1192.....	84	13.5361.....	226	14.0123.....	237	14.0622.....	243
13.2100.....	178	13.5370.....	226	14.0124.....	237	14.0623.....	243
13.2100SC.....	178	13.5371.....	226	14.0125.....	237	14.0624.....	243
13.2101.....	178	13.5380.....	226	14.0127.....	237	14.0625.....	243
13.2101SC.....	178	13.5381.....	226	14.0128.....	237	14.0627.....	243
13.2102.....	178	13.5382.....	222	14.0129.....	237	14.0628.....	243
13.2102SC.....	178	13.5383.....	222	14.0130.....	237	14.0629.....	243
13.2103.....	178	13.5601.....	84	14.0132.....	239	14.0630.....	243
13.2103SC.....	178	13.5621.....	84	14.0142.....	237	14.0632.....	239
13.2110.....	178	13.8003.....	228	14.0143.....	237	14.0633.....	243
13.2111.....	178	13.8005.....	228	14.0144.....	237	14.0657.....	243
13.2112.....	178	13.8007.....	228	14.0151.....	237	14.0681.....	243
13.2113.....	178	13.8023.....	229	14.0152.....	237	14.0682.....	243
13.2120.....	178	13.8025.....	229	14.0153.....	237	14.0683.....	243
13.2121.....	178	13.8027.....	229	14.0154.....	237	14.0684.....	243
13.2122.....	178	13.8029.....	229	14.0155.....	237	14.0687.....	243
13.2123.....	178	13.8043.....	230	14.0157.....	237	14.0688.....	243
13.2134.....	179	13.8045.....	230	14.0158.....	237	14.0689.....	243
13.2150.....	179	13.8047.....	230	14.0181.....	237	14.0701.....	243
13.2155.....	179	13.8049.....	230	14.0182.....	237	14.0702.....	243
13.2158.....	179	13.8100.....	232	14.0183.....	237	14.0703.....	243
13.2159.....	179	13.8110.....	232	14.0184.....	237	14.0704.....	243

Kat.Nr. Cat.No. No. Réf. No. Ref. No. Cat.	Seite Page Page Página Pagina	Kat.Nr. Cat.No. No. Réf. No. Ref. No. Cat.	Seite Page Page Página Pagina	Kat.Nr. Cat.No. No. Réf. No. Ref. No. Cat.	Seite Page Page Página Pagina	Kat.Nr. Cat.No. No. Réf. No. Ref. No. Cat.	Seite Page Page Página Pagina
14.0705.....	243	14.0980.....	248	14.2020.....	253	14.3102.....	262
14.0707.....	243	14.0982.....	248	14.2021.....	253	14.3102.2.....	262
14.0708.....	243	14.0984.....	248	14.2023.....	253	14.3104.....	262
14.0709.....	243	14.0988.....	249	14.2049.....	253	14.3104.2.....	262
14.0722.....	243	14.0990.....	249	14.2050.....	253	14.3106.....	262
14.0723.....	243	14.0994.....	249	14.2052.....	253	14.3106.2.....	262
14.0724.....	243	14.0996.....	249	14.2054.....	253	14.3108.....	262
14.0725.....	243	14.0998.....	249	14.2070.....	253	14.3108.2.....	262
14.0727.....	243	14.1000.....	250	14.2072.....	253	14.3110.....	262
14.0728.....	243	14.1002.....	250	14.2074.....	253	14.3110.2.....	262
14.0732.....	244	14.1004.....	250	14.2103.....	253	14.3112.....	262
14.0733.....	244	14.1006.....	250	14.2105.....	253	14.3112.2.....	262
14.0734.....	244	14.1007T.....	250	14.2107.....	253	14.3114.....	262
14.0735.....	244	14.1008T.....	250	14.2108.....	253	14.3114.2.....	262
14.0790.....	244	14.1009T.....	250	14.2109.....	253	14.3116.....	262
14.0792.....	244	14.1010.....	250	14.2110.....	253	14.3116.2.....	262
14.0800.....	244	14.1010T.....	250	14.2122.....	253	14.3118.....	262
14.0801.....	244	14.1012.....	250	14.2123.....	253	14.3118.2.....	262
14.0820.....	244	14.1012T.....	250	14.2125.....	253	14.3120.....	262
14.0821.....	244	14.1014.....	250	14.2127.....	253	14.3120.2.....	262
14.0825.....	244	14.1014T.....	250	14.2128.....	253	14.3122.....	262
14.0830.....	245	14.1016.....	250	14.2129.....	253	14.3122.2.....	262
14.0840.....	245	14.1016T.....	250	14.2130.....	253	14.3124.....	262
14.0842.....	245	14.1017T.....	250	14.2170.....	254	14.3124.2.....	262
14.0850.....	245	14.1018.....	240	14.2200.....	254	14.3126.....	262
14.0851.....	245	14.1018T.....	250	14.2202.....	254	14.3126.2.....	262
14.0852.....	245	14.1019T.....	250	14.2204.....	254	14.3128.....	262
14.0853.....	245	14.1021.....	250	14.2210.....	254	14.3128.2.....	262
14.0854.....	245	14.1021T.....	250	14.2212.....	254	14.3141.....	263
14.0855.....	245	14.1023.....	250	14.2214.....	254	14.3141.2.....	263
14.0860.....	245	14.1023T.....	250	14.2220.....	254	14.3143.....	263
14.0861.....	245	14.1025.....	250	14.2222.....	254	14.3143.2.....	263
14.0862.....	245	14.1025T.....	250	14.2224.....	254	14.3145.....	263
14.0865.....	245	14.1027.....	250	14.2230.....	254	14.3145.2.....	263
14.0866.....	246	14.1027T.....	250	14.2232.....	254	14.3147.....	263
14.0867.....	246	14.1030.....	250	14.2234.....	254	14.3147.2.....	263
14.0868.....	246	14.1030T.....	250	14.2240.....	254	14.3149.....	263
14.0869.....	246	14.1032.....	250	14.2242.....	254	14.3149.2.....	263
14.0870.....	246	14.1032T.....	250	14.2244.....	254	14.3151.....	263
14.0872.....	246	14.1034.....	250	14.2320.....	254	14.3151.2.....	263
14.0880.....	246	14.1034T.....	250	14.2390.....	254	14.3153.....	263
14.0885.....	246	14.1036.....	250	14.2570.....	254	14.3153.2.....	263
14.0890.....	246	14.1036T.....	250	14.2623.....	255	14.3155.....	263
14.0892.....	246	14.1040.....	251	14.2625.....	255	14.3155.2.....	263
14.0895.....	246	14.1040T.....	251	14.2627.....	255	14.3157.....	263
14.0896.....	246	14.1042.....	251	14.2628.....	255	14.3157.2.....	263
14.0897.....	246	14.1042T.....	251	14.2629.....	255	14.3159.....	263
14.0900.....	246	14.1044.....	251	14.2630.....	255	14.3159.2.....	263
14.0904.....	246	14.1044T.....	251	14.2820.....	254	14.3161.....	263
14.0910.....	247	14.1046.....	251	14.2890.....	255	14.3161.2.....	263
14.0912.....	247	14.1046T.....	251	14.2900.....	255	14.3163.....	263
14.0914.....	247	14.1050.....	251	14.3000.....	261	14.3163.2.....	263
14.0920.....	247	14.1050T.....	251	14.3000.2.....	261	14.3165.....	263
14.0922.....	247	14.1052.....	251	14.3002.....	261	14.3165.2.....	263
14.0925.....	247	14.1052T.....	251	14.3002.2.....	261	14.3167.....	263
14.0927.....	247	14.1054.....	251	14.3003.....	261	14.3167.2.....	263
14.0930.....	247	14.1054T.....	251	14.3003.2.....	261	14.3169.....	263
14.0932.....	247	14.1060.....	251	14.3005.....	261	14.3169.2.....	263
14.0934.....	247	14.1060T.....	251	14.3005.2.....	261	14.3202.....	264
14.0938.....	239	14.1062.....	251	14.3007.....	261	14.3202.2.....	264
14.0940.....	247	14.1062T.....	251	14.3007.2.....	261	14.3204.....	264
14.0948.....	247	14.1064.....	251	14.3009.....	261	14.3204.2.....	264
14.0950.....	247	14.1064T.....	251	14.3009.2.....	261	14.3206.....	265
14.0952.....	247	14.1070.....	252	14.3061.....	264	14.3206.2.....	265
14.0954.....	247	14.1072.....	252	14.3061.2.....	264	14.3208.....	265
14.0958.....	240	14.2000.....	253	14.3071.....	264	14.3208.2.....	265
14.0960.....	248	14.2001.....	253	14.3071.2.....	264	14.3212.....	264
14.0962.....	248	14.2002.....	253	14.3081.....	264	14.3212.2.....	264
14.0964.....	248	14.2005.....	253	14.3081.2.....	264	14.3214.....	264
14.0968.....	248	14.2007.....	253	14.3100.....	262	14.3214.2.....	264
14.0970.....	248	14.2010.....	253	14.3100.2.....	262	14.3216.....	265

Kat.Nr. Cat.No. No. Réf. No. Ref. No. Cat.	Seite Page Page Página Pagina	Kat.Nr. Cat.No. No. Réf. No. Ref. No. Cat.	Seite Page Page Página Pagina	Kat.Nr. Cat.No. No. Réf. No. Ref. No. Cat.	Seite Page Page Página Pagina	Kat.Nr. Cat.No. No. Réf. No. Ref. No. Cat.	Seite Page Page Página Pagina
14.3216.2	265	14.3722	260	15.0301	277	15.0478	288
14.3218	265	14.3722.2	260	15.0302	277	15.0479	288
14.3218.2	265	14.3724	260	15.0303	277	15.0480	280
14.3222	265	14.3724.2	260	15.0306	277	15.0481	280
14.3222.2	265	14.3726	260	15.0307	277	15.0482	281
14.3224	264	14.3726.2	260	15.0308	277	15.0484	281
14.3224.2	264	14.3728	260	15.0309	277	15.0486	281
14.3226	265	14.3728.2	260	15.0310	277	15.0492	281
14.3226.2	265	14.3900	266	15.0311	277	15.0493	281
14.3228	265	14.3905	266	15.0313	277	15.0494	281
14.3228.2	265	14.3910	266	15.0315	277	15.0495	281
14.3500	257	14.3915	266	15.0316	277	15.0496	281
14.3500.2	257	14.3920	266	15.0317	277	15.0497	281
14.3502	257	14.3925	266	15.0320	278	15.0499	289
14.3502.2	257	14.3930	266	15.0321	278	15.0503	289
14.3503	257	14.3935	266	15.0323	278	15.0620	282
14.3503.02	257	14.3940	266	15.0324	278	15.0621	282
14.3505	257	14.3945	266	15.0325	278	15.0622	282
14.3505.2	257	14.3950	266	15.0331	278	15.0623	282
14.3600	258	14.3955	266	15.0335	278	15.0624	282
14.3600.2	258			15.0360	278	15.0625	282
14.3602	258	15...		15.0361	278	15.0626	282
14.3602.2	258	15.0098	273	15.0362	278	15.0627	282
14.3604	258	15.0100	273	15.0363	278	15.0628	282
14.3604.2	258	15.0101	273	15.0364	278	15.0629	282
14.3606	258	15.0102	273	15.0365	278	15.0630	282
14.3606.2	258	15.0103	273	15.0366	278	15.0631	282
14.3610	258	15.0104	273	15.0367	278	15.0632	282
14.3610.2	258	15.0105	273	15.0392	279	15.0633	282
14.3612	258	15.0108	273	15.0393	279	15.0634	292,290
14.3612.2	258	15.0116	274	15.0404	279	15.0635	292,290
14.3614	258	15.0117	274	15.0406	279	15.0701	283
14.3614.2	258	15.0120	274	15.0408	279	15.0703	283
14.3616	258	15.0120L	274	15.0410	279	15.0720	283
14.3616.2	258	15.0121	274	15.0411	279	15.0721	283
14.3620	258	15.0121L	274	15.0412	279	15.0722	283
14.3620.2	258	15.0122	274	15.0413	279	15.0723	283
14.3622	258	15.0123	274	15.0414	279	15.0724	283
14.3622.2	258	15.0124	274	15.0415	279	15.0725	283
14.3624	258	15.0125	274	15.0416	279	15.0726	283
14.3624.2	258	15.0126	274	15.0417	279	15.0727	283
14.3626	258	15.0127	274	15.0418	279	15.0729	283
14.3626.2	258	15.0128	274	15.0419	279	15.0731	284
14.3641	259	15.0129	274	15.0430	279	15.0732	284
14.3641.2	259	15.0130	275	15.0431	279	15.0733	284
14.3643	259	15.0131	275	15.0432	279	15.0734	284
14.3643.2	259	15.0136	274	15.0433	279	15.0741	284
14.3651	259	15.0137	274	15.0450	280	15.0743	284
14.3651.2	259	15.0139	274	15.0451	280	15.0745	284
14.3653	259	15.0180	275	15.0452	280	15.0762	284
14.3653.2	259	15.0181	275	15.0453	280	15.0764	284
14.3661	259	15.0200	275	15.0454	280	15.0765	284
14.3661.2	259	15.0201	275	15.0455	280	15.0766	284
14.3663	259	15.0210	275	15.0458	280	15.0770	284
14.3663.2	259	15.0211	275	15.0459	280	15.0771	284
14.3702	260	15.0212	275	15.0460	280	15.0772	284
14.3702.2	260	15.0213	275	15.0461	280	15.0773	284
14.3704	260	15.0214	275	15.0462	280	15.0774	284
14.3704.2	260	15.0215	275	15.0463	280	15.0775	284
14.3706	260	15.0240	276	15.0464	280	15.0776	284
14.3706.2	260	15.0241	276	15.0465	280	15.0778	293,291
14.3708	260	15.0250	276	15.0466	280	15.0780	285
14.3708.2	260	15.0251	276	15.0467	280	15.0782	285
14.3712	260	15.0252	276	15.0468	280	15.0784	285
14.3712.2	260	15.0253	276	15.0469	280	15.0785	285
14.3714	260	15.0260	276	15.0470	280	15.0801	285
14.3714.2	260	15.0261	276	15.0471	280	15.0802	285
14.3716	260	15.0262	276	15.0472	280	15.0803	285
14.3716.2	260	15.0263	276	15.0473	280	15.0807	286
14.3718	260	15.0269	287	15.0476	280	15.0809	286
14.3718.2	260	15.0300	277	15.0477	280	15.0811	286

Kat.Nr. Cat.No. No. Réf. No. Ref. No. Cat.	Seite Page Page Página Pagina	Kat.Nr. Cat.No. No. Réf. No. Ref. No. Cat.	Seite Page Page Página Pagina	Kat.Nr. Cat.No. No. Réf. No. Ref. No. Cat.	Seite Page Page Página Pagina	Kat.Nr. Cat.No. No. Réf. No. Ref. No. Cat.	Seite Page Page Página Pagina
15.0813.....	286	15.2318.....	149	16.0224.....	299	16.1115.....	375
15.0817.....	286	15.2319.....	149	16.0230.....	299	16.1150.....	375
15.0831.....	286	15.2321.....	149	16.0232.....	299	16.1152.....	375
15.0833.....	286	15.2324.....	149	16.0234.....	299	16.1153.....	375
15.0835.....	286	15.2325.....	149	16.0280.....	299	16.1154.....	375
15.0841.....	79	15.2330.....	150	16.0290.....	299	16.1155.....	375
15.0843.....	79	15.2331.....	150	16.0300.....	302	16.1156.....	375
15.0901.....	79	15.2332.....	150	16.0360.....	302	16.1157.....	375
15.0903.....	79	15.2333.....	150	16.0362.....	302	16.1158.....	375
15.0911.....	79	15.2335.....	150	16.0364.....	302	16.1159.....	375
15.0913.....	79	15.2337.....	150	16.0370.....	302	16.1500.....	375
15.0931.....	80	15.2340.....	151	16.0371.....	302		
15.0941.....	80	15.2344.....	151	16.0390.....	300		
15.1015.....	80	15.2345.....	152	16.0391.....	300	17...	
15.1031.....	80	15.2347.....	152	16.0400.....	300	17.0001.....	99
15.1033.....	80	15.2348.....	152	16.0401.....	300	17.0576.....	317
15.1035.....	80	15.2349.....	152	16.0406.....	300	17.0620.....	307
15.1037.....	80	15.2360.....	153	16.0407.....	300	17.0621.....	307
15.1200.....	27	15.2361.....	153	16.0408.....	300	17.0622.....	307
15.1204.....	27	15.2362.....	153	16.0409.....	300	17.0623.....	307
15.1270.....	27	15.2363.....	153	16.0410.....	300	17.0624.....	307
15.1272.....	27	15.2365.....	153	16.0411.....	300	17.0625.....	307
15.1300.....	27	15.2366.....	153	16.0416.....	83,300	17.0626.....	307
15.1302.....	27	15.2367.....	153	16.0417.....	83,300	17.0629.....	307
15.1320.....	279	15.2368.....	153	16.0418.....	301	17.0665.....	307
15.1321.....	279	15.2380.....	154	16.0419.....	301	17.0666.....	307
15.1322.....	279	15.2381.....	154	16.0420.....	301	17.0667.....	307
15.1323.....	279	15.2382.....	154	16.0422.....	301	17.0670.....	307
15.1340.....	187	15.2383.....	154	16.0423.....	301	17.0671.....	91
15.1342.....	187	15.2384.....	154	16.0424.....	301	17.0672.....	91
15.1350.....	32	15.2385.....	154	16.0425.....	301	17.0673.....	91
15.1580.....	32,83	15.2386.....	154	16.0426.....	302	17.0674.....	91
15.1582.....	32,83	15.2387.....	154	16.0427.....	302	17.0675.....	91
15.1721.....	283	15.2388.....	154	16.0430.....	302	17.0676.....	91
15.1722.....	283	15.2389.....	154	16.0431.....	302	17.0680.....	91
15.1723.....	283	15.2390.....	154	16.0436.....	293	17.0681.....	91
15.1724.....	283	15.2391.....	154	16.0440.....	303	17.0682.....	91
15.1725.....	283	15.2392.....	154	16.0441.....	303	17.0683.....	91
15.1726.....	283	15.2393.....	154	16.0450.....	303	17.0684.....	91
15.1727.....	283	15.2394.....	154	16.0451.....	303	17.0900.....	308
15.1930.....	88	15.2395.....	154	16.0452.....	303	17.0910.....	308
15.1931.....	88			16.0453.....	303	17.0912.....	308
15.1933.....	88	16...		16.0454.....	303	17.0920.....	308
15.1935.....	88	16.0010.....	297	16.0455.....	303	17.0922.....	308
15.1936.....	293,291	16.0012.....	297	16.0460.....	303	17.0925.....	308
15.1937.....	88	16.0031.....	297	16.0461.....	303	17.0930.....	309
15.1940.....	88	16.0100.....	297	16.0462.....	303	17.0931.....	309
15.1960.....	88	16.0102.....	297	16.0463.....	303	17.0932.....	309
15.2125.....	146	16.0105.....	297	16.0466.....	303	17.0934.....	309
15.2200.....	146	16.0106.....	297	16.0470.....	303	17.1000.....	309
15.2202.....	146	16.0107.....	297	16.0471.....	303	17.1010.....	309
15.2209.....	146	16.0108.....	297	16.0472.....	303	17.1086.....	310
15.2211.....	146	16.0112.....	297	16.0473.....	303	17.1087.....	310
15.2215.....	146	16.0115.....	298	16.0500.....	304	17.1088.....	310
15.2216.....	146	16.0116.....	298	16.0501.....	304	17.1090.....	310
15.2217.....	146	16.0120.....	298	16.0505.....	304	17.1091.....	310
15.2218.....	146	16.0125.....	298	16.0510.....	304	17.1092.....	310
15.2221.....	147	16.0132.....	298	16.0520.....	304	17.1093.....	85,311
15.2223.....	147	16.0135.....	298	16.1000.....	374	17.1094.....	85,311
15.2225.....	147	16.0140.....	298	16.1002.....	374	17.1095.....	311
15.2230.....	148	16.0145.....	298	16.1004.....	375	17.1096.....	311
15.2232.....	148	16.0150.....	297	16.1010.....	374	17.1097.....	310
15.2234.....	148	16.0160.....	298	16.1020.....	374	17.1098.....	310
15.2300.....	148	16.0164.....	298	16.1030.....	374	17.1099.....	310
15.2301.....	148	16.0170.....	298	16.1032.....	374	17.1100.....	312
15.2311.....	149	16.0180.....	298	16.1050.....	374	17.1101.....	311
15.2313.....	149	16.0200.....	299	16.1052.....	374	17.1102.....	311
15.2314.....	149	16.0202.....	299	16.1060.....	374	17.1103.....	311
15.2315.....	149	16.0210.....	299	16.1070.....	374	17.1104.....	311
15.2316.....	149	16.0220.....	299	16.1100.....	375	17.1105.....	312
15.2317.....	149	16.0222.....	299	16.1110.....	375	17.1106.....	312

Kat.Nr. Cat.No. No. Réf. No. Ref. No. Cat.	Seite Page Page Página Pagina	Kat.Nr. Cat.No. No. Réf. No. Ref. No. Cat.	Seite Page Page Página Pagina	Kat.Nr. Cat.No. No. Réf. No. Ref. No. Cat.	Seite Page Page Página Pagina	Kat.Nr. Cat.No. No. Réf. No. Ref. No. Cat.	Seite Page Page Página Pagina
17.1107	312	17.6010	325	17.6702	339	18.0212	357
17.1108	312	17.6015	325	17.6703	339	18.0214	357
17.1109	312	17.6020	326	17.6704	339	18.0220	357
17.1110	312	17.6030	326	17.6710	340	18.0242	355
17.1111	61	17.6035	326	17.6711	340	18.0244	355
17.1112	61	17.6040	327	17.6712	340	18.0246	355
17.1113	61	17.6100	327	17.6713	340	18.0250	358
17.1114	61	17.6101	327	17.6714	340	18.0252	358
17.1115	61	17.6102	327	17.6715	340	18.0254	358
17.1116	61	17.6110	328	17.6716	340	18.0256	358
17.1117	61	17.6150	328	17.6717	340	18.0260	358
17.1118	85,311	17.6152	328	17.6718	340	18.0262	358
17.1119	85,311	17.6153	328	17.7000	341	18.0264	358
17.1120	313	17.6154	329	17.7001	341	18.0266	358
17.1121	313	17.6155	329	17.7002	341	18.0270	358
17.1122	313	17.6156	330	17.7012	341	18.0272	358
17.1123	313	17.6157	330	17.7022	341	18.0274	358
17.1124	313	17.6158	330			18.0280	358
17.1125	313	17.6159	330	18...		18.0800	345
17.1130	313	17.6170	330	18.0016TD	353	18.0801	345
17.1131	313	17.6172	330	18.0050	353	18.0802	345
17.1132	313	17.6173	330	18.0069	353	18.0803	345
17.1133	313	17.6174	330	18.0070	353	18.0804	345
17.1154	313	17.6176	330	18.0070L	353	18.0805	345
17.1166	85	17.6177	330	18.0070TD	353	18.0810	345
17.1167	85	17.6178L	330	18.0071	353	18.0811	345
17.1168	85	17.6178R	330	18.0072	353	18.0812	345
17.1169	85	17.6180	331	18.0072L	353	18.0813	345
17.1270	315	17.6181	331	18.0074	353	18.0814	345
17.1271	315	17.6182	331	18.0074L	353	18.0815	345
17.1272	315	17.6183	331	18.0076	353	18.0840	345
17.1273	315	17.6185	331	18.0076L	353	18.1050	359
17.1273C	314	17.6186	331	18.0080	354	18.1060	359
17.1274	315	17.6210	332	18.0080L	354	18.1065	359
17.1274C	314	17.6211	332	18.0082	354	18.1070	359
17.1275	315,317	17.6222	332	18.0082L	354	18.1072	359
17.1275.36	317	17.6224	332	18.0084	354	18.1074	359
17.1276	316	17.6225	332	18.0084HP	354	18.1076	359
17.1276C	314	17.6228	332	18.0084L	354	18.1078	359
17.1277	316	17.6229	332	18.0086	354	18.1080	359
17.1277C	314	17.6230	332	18.0086HP	354	18.1082	359
17.1278	316	17.6250	333	18.0086L	354	18.1084	359
17.1278C	314	17.6251	333	18.0088	354	18.1086	359
17.1279	316	17.6252	333	18.0088L	354	18.1088	359
17.1279C	314	17.6253	333	18.0090	354	18.1090	359
17.1280	62	17.6254	333	18.0092	354	18.1092	359
17.1281	62	17.6255	333	18.0094	354	18.1094	359
17.1282	62	17.6256	333	18.0096	354	18.1100	360
17.1284	62	17.6260	334	18.0100	354	18.1110	360
17.1285	62	17.6261	334	18.0100TD	353	18.1152	360
17.1286	62	17.6262	334	18.0102	354	18.1154	360
17.5670	321	17.6263	334	18.0102TD	353	18.1160	360
17.5672	321	17.6270	335	18.0104	354	18.1161	360
17.5890	321	17.6271	335	18.0104TD	353	18.1162	360
17.5892	321	17.6272	335	18.0106	354	18.1164	360
17.5899	322	17.6273	335	18.0108	354	18.1170	361
17.5900	322	17.6274	335	18.0110	354	18.1180	361
17.5901	322	17.6277	335	18.0150	355	18.1190	361
17.5902	322	17.6278	335	18.0152	355	18.1200	361
17.5905	322	17.6279	335	18.0160	355	18.1212	361
17.5906	323	17.6300	337	18.0162	355	18.1214	361
17.5907	323	17.6301	337	18.0164	355	18.1800	345
17.5908	323	17.6303	337	18.0166	355	18.1801	345
17.6000	324	17.6304	337	18.0170	356	18.1802	345
17.6001	324	17.6309	337	18.0180	356	18.1803	345
17.6001.1	324	17.6350	336	18.0190	356	18.1804	345
17.6001.2	324	17.6353	336	18.0192	356	18.1805	345
17.6002	324	17.6354	336	18.0194	356	18.1810	345
17.6003	324	17.6355	336	18.0202	357	18.1811	345
17.6004	324	17.6700	338	18.0204	357	18.1812	345
17.6007	325	17.6701	339	18.0210	357	18.1813	345

Kat.Nr.
Cat.No.
No. Réf.
No. Ref.
No. Cat.

Seite
Page
Page
Página
Pagina

18.1814..... 345
18.1815..... 345
18.1840..... 345
18.1850..... 345

19...

19.0101..... 365
19.0102..... 365
19.0103..... 365
19.0104..... 365
19.0105..... 365
19.0106..... 365
19.0109..... 365
19.0110..... 365
19.0111..... 365
19.0112..... 365
19.0113..... 365
19.0114..... 365
19.0115..... 365
19.0116..... 365
19.0117..... 365
19.0119..... 365
19.0120..... 365
19.0121..... 365
19.0122..... 365
19.0123..... 365
19.0124..... 365
19.0125..... 365
19.0126..... 365
19.0127..... 365
19.0128..... 365
19.0200..... 365
19.0201..... 365
19.0202..... 365
19.0203..... 365
19.0204..... 365
19.0205..... 365
19.0206..... 365
19.0207..... 365
19.0210..... 365
19.0211..... 365
19.0212..... 365
19.0213..... 365
19.0214..... 365
19.0215..... 365
19.0216..... 365
19.0302..... 366
19.0303..... 366
19.0320..... 366
19.0321..... 366
19.0322..... 366
19.0323..... 366
19.0324..... 366
19.0325..... 366
19.0332..... 366
19.0351..... 366
19.0352..... 366
19.0353..... 366
19.0354..... 366
19.0355..... 366
19.0356..... 366
19.0363..... 366
19.0371..... 63,366
19.0372..... 63,366
19.0373..... 63,366
19.0374..... 63,366
19.0700..... 367
19.0710..... 367
19.0711..... 367
19.0712..... 367
19.0713..... 367

Kat.Nr.
Cat.No.
No. Réf.
No. Ref.
No. Cat.

Seite
Page
Page
Página
Pagina

19.0715..... 367
19.0718..... 367
19.0720..... 368
19.0721..... 368
19.0722..... 368,370
19.0723..... 368,370
19.0724..... 368,370
19.0726..... 368
19.0727..... 368
19.0738..... 368,370
19.0746..... 368
19.0747..... 368
19.0748..... 368
19.0750..... 369,370
19.0751..... 369
19.0752..... 369
19.0753..... 369
19.0754..... 369
19.1010..... 371
19.1020..... 371
19.1021..... 371
19.1022..... 371
19.1023..... 371
19.1024..... 371
19.1025..... 371
19.1026..... 371
19.1030..... 371
19.1031..... 371
19.1032..... 371
19.1033..... 371
19.1034..... 371
19.1035..... 371
19.1036..... 371
19.1050..... 371
19.1199..... 371
19.1200..... 371
19.1201..... 371
19.1202..... 371
19.1204..... 371
19.1205..... 371
19.1206..... 371
19.1210..... 371
19.1211..... 371
19.1212..... 371
19.1213..... 371
19.3000..... 87
19.3001..... 87
19.3010..... 87
19.3011..... 87
19.3020..... 87
19.3021..... 87
19.3030..... 87
19.3040..... 87
19.3041..... 87
19.3043..... 87
19.3044..... 87
19.3051..... 87
19.3053..... 87

28...

28.0320T..... 251
28.0322S..... 251
28.0322T..... 251
28.0324S..... 251
28.0324T..... 251
28.0326S..... 251
28.0326T..... 251
28.0330S..... 251
28.0330T..... 251
28.0332S..... 251
28.0332T..... 251

Kat.Nr.
Cat.No.
No. Réf.
No. Ref.
No. Cat.

Seite
Page
Page
Página
Pagina

28.0334S..... 251
28.0334T..... 251
28.0336S..... 251
28.0336T..... 251
28.2102..... 209
28.2103..... 209
28.2104..... 209
28.2105..... 209
28.2112..... 209
28.2113..... 209
28.2114..... 209
28.2115..... 209
28.2124..... 209
28.2125..... 209
28.2150..... 209
28.2151..... 209
28.2460..... 210
28.2460T..... 210
28.2461..... 210
28.2461T..... 210
28.2462..... 210
28.2462T..... 210
28.2463..... 210
28.2463T..... 210
28.2464..... 210
28.2464T..... 210
28.2470..... 210
28.2470T..... 210
28.2471..... 210
28.2471T..... 210
28.2472..... 210
28.2472T..... 210
28.2473..... 210
28.2473T..... 210
28.2474..... 210
28.2474T..... 210
28.2600..... 211
28.2601..... 211
28.2602..... 211
28.2603..... 211
28.2605..... 211
28.2608..... 211
28.2609..... 211
28.2620..... 212
28.2622..... 212
28.2623..... 212
28.2624..... 212
28.2625..... 212
28.2628..... 212
28.2629..... 212
28.2640..... 212
28.2641..... 212
28.2656..... 213
28.2657..... 213
28.2659..... 213
28.3154..... 346
28.3155..... 346
28.3156..... 346
28.3157..... 346
28.3242..... 347
28.3243..... 347
28.3252..... 347
28.3253..... 347
28.3254..... 348
28.3255..... 348
28.3256..... 348
28.3257..... 348
28.3501..... 352
28.3504..... 352
28.3505..... 352
28.3506..... 352

Kat.Nr.
Cat.No.
No. Réf.
No. Ref.
No. Cat.

Seite
Page
Page
Página
Pagina

28.3507..... 352
28.3509..... 352
28.3630..... 350
28.3630S..... 350
28.3630SD..... 350
28.3631..... 350
28.3631S..... 350
28.3631SD..... 350
28.3632..... 350
28.3632S..... 350
28.3632SD..... 350
28.3633..... 350
28.3633S..... 350
28.3633SD..... 350
28.3634..... 350
28.3634S..... 350
28.3634SD..... 350
28.3635..... 350
28.3635S..... 350
28.3635SD..... 350
28.3636..... 350
28.3636S..... 350
28.3636SD..... 350
28.3637..... 350
28.3637S..... 350
28.3637SD..... 350
28.3640..... 350
28.3640S..... 350
28.3640SD..... 350
28.3641..... 350
28.3641S..... 350
28.3641SD..... 350
28.3642..... 350
28.3642S..... 350
28.3642SD..... 350
28.3643..... 350
28.3643S..... 350
28.3643SD..... 350
28.3644..... 350
28.3644S..... 350
28.3644SD..... 350
28.3645..... 350
28.3645S..... 350
28.3645SD..... 350
28.3646..... 350
28.3646S..... 350
28.3646SD..... 350
28.3647..... 350
28.3647S..... 350
28.3647SD..... 350
28.3662..... 349
28.3662D..... 349
28.3664..... 351
28.3664D..... 351
28.3700..... 351
28.3700S..... 351
28.3700SD..... 351
28.3701..... 351
28.3701S..... 351
28.3701SD..... 351
28.3702..... 351
28.3702S..... 351
28.3702SD..... 351
28.3703..... 351
28.3703S..... 351
28.3703SD..... 351
28.7050..... 13
28.7055..... 13
28.7057..... 13
28.7058..... 13
28.7059..... 13

Kat.Nr. Cat.No. No. Réf. No. Ref. No. Cat.	Seite Page Page Página Pagina	Kat.Nr. Cat.No. No. Réf. No. Ref. No. Cat.	Seite Page Page Página Pagina	Kat.Nr. Cat.No. No. Réf. No. Ref. No. Cat.	Seite Page Page Página Pagina	Kat.Nr. Cat.No. No. Réf. No. Ref. No. Cat.	Seite Page Page Página Pagina
33...		48.0062.....	29	48.0312.....	43	48.1302.....	63
33.1160.....	367	48.0064.....	29	48.0313.....	43	48.1303.....	63
40...		48.0066.....	29	48.0350.....	43	48.1310.....	63
40.0705.....	292	48.0068.....	29	48.0510.....	44	48.1420.....	64
40.3400.....	323	48.0069.....	29,293	48.0511.....	44	48.1601.....	64
41...		48.0072.....	30	48.0512.....	44	48.1602.....	64
41.0000.....	269	48.0074.....	30	48.0513.....	44	48.1603.....	64
41.0001.....	269	48.0076.....	30	48.0530.....	46	48.1700.....	65
41.0005.....	269	48.0078.....	30	48.0532.....	46	48.1702.....	70
41.0006.....	269	48.0082.....	30	48.0534.....	46	48.1704.....	70
41.0010.....	269	48.0086.....	30	48.0536.....	46	48.1709.....	65,66
41.0011.....	269	48.0088.....	30	48.0537.....	46	48.1710.....	65
41.0015.....	269	48.0089.....	31	48.0538.....	46	48.1715.....	65
41.0016.....	269	48.0090.....	31	48.0700.....	45	48.1719.....	65
41.0019.....	269	48.0092.....	31	48.0710.....	45	48.1730.....	66
41.0020.....	270	48.0094.....	31	48.0900.....	47	48.1740.....	66
41.0021.....	270	48.0094AT.....	31	48.0902.....	47	48.1742.....	66
41.0022.....	270	48.0098.....	31	48.0904.....	47	48.1748.....	66
41.0023.....	270	48.0098AT.....	31	48.1000.....	48	48.1749.....	66,67,68
41.0024.....	270	48.0099.....	31	48.1005.....	48	48.1750.....	67
41.0025.....	270	48.0100.....	33	48.1006.....	48	48.1755.....	67
41.0028.....	271	48.0101.....	33	48.1007.....	48	48.1756.....	68
41.0030.....	271	48.0102.....	33	48.1020.....	49	48.1760.....	68
41.0031.....	271	48.0103.....	33	48.1030.....	49	48.1780.....	69
41.0032.....	271	48.0104.....	33	48.1040.....	49	48.1781.....	69
41.0033.....	271	48.0105.....	33	48.1046.....	50	48.1787.....	69
41.0034.....	271	48.0106.....	33	48.1047.....	50	48.1788.....	69
41.0035.....	271	48.0107.....	33	48.1050.....	50	48.1789.....	69
41.0037.....	271	48.0110.....	34	48.1051.....	50	48.1900.....	70
41.0090.....	272	48.0111.....	34	48.1052.....	50	48.2001.....	71
41.0091.....	272	48.0112.....	34	48.1053.....	50	48.2002.....	71
41.0092.....	272	48.0113.....	34	48.1054.....	50	48.2003.....	71
41.0093.....	272	48.0114.....	34	48.1055.....	47	48.2004.....	71
41.0094.....	272	48.0115.....	34	48.1070.....	51	48.2011.....	71
41.0095.....	272	48.0118.....	35	48.1080.....	51	48.2012.....	71
41.0099.....	272	48.0119.....	35	48.1136.....	55	48.2013.....	71
41.0100.....	272	48.0120.....	35	48.1137.....	55	48.2014.....	71
41.0101.....	272	48.0121.....	35	48.1138.....	55	48.2015.....	71
41.0110.....	272	48.0122.....	36	48.1139.....	55	48.2016.....	71
41.0111.....	272	48.0123.....	36	48.1140.....	55	48.2017.....	71
41.0115.....	272	48.0150.....	37	48.1141.....	56	48.2018.....	71
41.0116.....	272	48.0151.....	37	48.1142.....	56	48.2020.....	71
41.0120.....	272	48.0152.....	37	48.1143.....	56	48.2022.....	71
41.0121.....	272	48.0153.....	37	48.1144.....	56	48.2024.....	71
46...		48.0154.....	37	48.1145.....	56	48.2030.....	71
46.0169.....	336	48.0155.....	37	48.1146.....	56	48.2032.....	71
48...		48.0156.....	37	48.1147.....	56	48.2034.....	71
48.0004.....	27	48.0157.....	37	48.1148.....	56	48.2200.....	70
48.0006.....	27	48.0158.....	37	48.1159.....	55	50...	
48.0010.....	27	48.0159.....	37	48.1200.....	52	50.0061.....	75
48.0011.....	27	48.0160.....	38	48.1202.....	52	50.0062.....	75
48.0014.....	27	48.0161.....	38	48.1210.....	52	50.0063.....	75
48.0016.....	27	48.0162.....	38	48.1212.....	52	50.0100.....	76
48.0019.....	27,292	48.0163.....	38	48.1214.....	52	50.0103.....	76
48.0024.....	28	48.0164.....	38	48.1216.....	52	50.0104.....	76
48.0028.....	28	48.0165.....	38	48.1220.....	52	50.0105.....	76
48.0029.....	28	48.0170.....	39	48.1230.....	52	50.0106.....	76
48.0030.....	28	48.0172.....	39	48.1232.....	52	50.0107.....	76
48.0032.....	28	48.0180.....	39	48.1234.....	52	50.0108.....	76
48.0034.....	28	48.0184.....	40	48.1236.....	52	50.0109.....	76
48.0035.....	28	48.0186.....	40	48.1240.....	53	50.0110.....	76
48.0036.....	28	48.0190.....	41	48.1242.....	53	50.0111.....	76
48.0038.....	28	48.0191.....	41	48.1244.....	53	50.0112.....	76
48.0040.....	29	48.0200.....	42	48.1246.....	53	50.0120.....	76
48.0045.....	29	48.0201.....	42	48.1249.....	50,53,109	50.0121.....	76
48.0050.....	29	48.0203.....	42	48.1250.....	53	50.0122.....	76
		48.0204.....	42	48.1252.....	53	50.0123.....	76
		48.0205.....	42	48.1255.....	53	50.0124.....	76
		48.0207.....	42	48.1256.....	54	50.0125.....	76
		48.0210.....	33	48.1270.....	57	50.0126.....	76
		48.0300.....	43	48.1301.....	63	50.0127.....	76

Kat.Nr. Cat.No. No. Réf. No. Ref. No. Cat.	Seite Page Page Página Pagina	Kat.Nr. Cat.No. No. Réf. No. Ref. No. Cat.	Seite Page Page Página Pagina	Kat.Nr. Cat.No. No. Réf. No. Ref. No. Cat.	Seite Page Page Página Pagina	Kat.Nr. Cat.No. No. Réf. No. Ref. No. Cat.	Seite Page Page Página Pagina
50.0128	76	51.0072	101	51.1121	104	55.0105	116
50.0129	76	51.0080	100	51.1122	104	55.0110	117
50.0130	76	51.0090	101	51.1123	104	55.0111	117
50.0131	76	51.0097	101	51.1124	104	55.0112	117
50.0132	76	51.0098	101	51.1125	104	55.0113	117
50.0133	76	51.0099	101	51.1126	104	55.0114	117
50.0140	75	51.0106	102	51.1127	104	55.0115	117
50.0200	77	51.0107	102	51.1128	104	55.0116	117
50.0204	77	51.0108	102	51.1129	104	55.0117	117
50.0205	77	51.0109	102	51.1130	104	55.0118	117
50.0206	77	51.0110	102	51.1140	104	55.0119	117
50.0210	77	51.0112	102			55.0120	117
50.0240	77	51.0114	102	55...		55.0130	118
50.0270	78	51.0116	102	55.0010	107	55.0190	118
50.0271	78	51.0118	102	55.0011	111	55.0193	118
50.0272	78	51.0120	102	55.0011B	111	55.0196	118
50.0273	78	51.0122	102	55.0011HF	111	55.0200	118
50.0274	78	51.0124	102	55.0012	111	55.0201	118
50.0275	78	51.0136	102	55.0012B	111	55.0202	118
50.0276	78	51.0137	102	55.0012HF	111	55.0203	118
50.0277	78	51.0138	102	55.0013	111	55.0204	118
50.0300	81	51.0139	102	55.0013B	111	55.0205	118
50.0301	81	51.0140	102	55.0013HF	111	55.0206	118
50.0311	81	51.0141	102	55.0014	110	55.0207	118
50.0313	81	51.0142	102	55.0015	110	55.0208	118
50.0315	81	51.0143	102	55.0016	110	55.0210	119
50.0317	81	51.0144	102	55.0017	110	55.0211	119
50.0320	82	51.0145	102	55.0018	110	55.0212	119
50.0321	82	51.0146	102	55.0019	110	55.0213	119
50.0325	82	51.0148	102	55.0020	112	55.0214	119
50.0330	82	51.0150	102	55.0020B	112	55.0215	119
50.0340	89	51.0152	102	55.0020HF	112	55.0216	119
50.0342	89	51.0154	102	55.0021	112	55.0217	119
50.0344	89	51.0302	102	55.0021B	112	55.0218	119
50.0346	89	51.0303	102	55.0021HF	112	55.0220	120
50.0347	89	51.0350	103	55.0022	112	55.0221	120
50.0348	89	51.0600	103	55.0022B	112	55.0222	120
50.0350	89	51.0610	103	55.0022HF	112	55.0223	120
50.0401	90	51.0720	103	55.0025	107	55.0224	120
50.0402	90	51.0800	103	55.0030	113	55.0225	120
50.1009	92	51.0802	103	55.0030B	113	55.0226	120
50.1011	92	51.1008	104	55.0030HF	113	55.0227	120
50.1013	92	51.1010	104	55.0031	113	55.0228	120
50.1015	92	51.1012	104	55.0031B	113	55.0230	108
50.1018	92	51.1014	104	55.0031HF	113	55.0231	108
50.3100	86	51.1016	104	55.0032	113	55.0233	108
50.3102	86	51.1018	104	55.0032B	113	55.0234	108
50.3104	86	51.1020	104	55.0032HF	113	55.0236	108
50.3106	86	51.1022	104	55.0036	115	55.0237	108
		51.1024	104	55.0040	107,114	55.0240	121
51...		51.1026	104	55.0040B	114	55.0243	121
51.0004	95	51.1028	104	55.0040HF	114	55.0246	121
51.0009	95	51.1030	104	55.0041	114	55.0248	122
51.0010	95	51.1032	104	55.0041B	114	55.0249	122
51.0011	95	51.1034	104	55.0041HF	114	55.0250	122
51.0015	95	51.1036	104	55.0042	114	55.0251	122
51.0020	96,100	51.1040	104	55.0042B	114	55.0252	122
51.0040	96	51.1107	104	55.0042HF	114	55.0253	122
51.0041	96	51.1108	104	55.0045	114	55.0260	123
51.0042	96	51.1109	104	55.0050	115	55.0261	123
51.0043	99	51.1110	104	55.0051	115	55.0262	123
51.0044	99	51.1111	104	55.0052	115	55.0265	123
51.0045	99	51.1112	104	55.0060	115	55.0270	123
51.0050	97	51.1113	104	55.0062	115	55.0271	123
51.0053	97	51.1114	104	55.0066	115	55.0272	123
51.0055	98	51.1115	104	55.0067	115	55.0275	123
51.0056	98	51.1116	104	55.0068	115	55.0276	123
51.0057	98	51.1117	104	55.0100	116	55.0277	123
51.0058	98	51.1118	104	55.0101	116	55.0280	124
51.0060	99	51.1119	104	55.0102	116	55.0281	124
51.0070	100	51.1120	104	55.0103	116	55.0282	124

Kat.Nr. Cat.No. No. Réf. No. Ref. No. Cat.	Seite Page Page Página Pagina	Kat.Nr. Cat.No. No. Réf. No. Ref. No. Cat.	Seite Page Page Página Pagina	Kat.Nr. Cat.No. No. Réf. No. Ref. No. Cat.	Seite Page Page Página Pagina	Kat.Nr. Cat.No. No. Réf. No. Ref. No. Cat.	Seite Page Page Página Pagina
55.0283	124	55.0736	128	55.0984	139	55.1910	160
55.0284	124	55.0737	128	55.0990	132	55.1915	160
55.0285	124	55.0741	129	55.0991	132	55.1920	160
55.0286	124	55.0743	129	55.1001	130	55.1922	160
55.0287	124	55.0745	129	55.1001S	130	55.1962	161
55.0288	124	55.0747	129	55.1004	130	55.1973	161
55.0289	124	55.0749	129	55.1004S	130	55.1975	161
55.0294	124	55.0751	129	55.1021	130	55.1980	161
55.0299	124	55.0753	129	55.1024	130	55.2001	164
55.0310	124	55.0755	129	55.1030	130	55.2002	164
55.0311	124	55.0757	129	55.1100	131	55.2003	164
55.0320	125	55.0759	129	55.1110	131	55.2004	164
55.0321	125	55.0761	129	55.1120	131	55.2005	164
55.0322	125	55.0763	129	55.1200	131	55.2006	164
55.0323	125	55.0765	129	55.1500	140	55.2010	164
55.0324	125	55.0772	129	55.1510	140	55.2019	166
55.0325	125	55.0773	129	55.1511	141	55.2020	166
55.0326	125	55.0775	129	55.1520	90,141	55.2021	166
55.0327	125	55.0776	129	55.1525	132	55.2022	166
55.0328	125	55.0777	129	55.1526	132	55.2023	166
55.0329	125	55.0791	128	55.1551	144	55.2024	166
55.0335	125	55.0792	128	55.1552	144	55.2025	166
55.0340	125	55.0793	128	55.1553	144	55.2026	166
55.0342	125	55.0794	128	55.1554	144	55.2039	166
55.0350	126	55.0795	128	55.1555	144	55.2040	166
55.0351	126	55.0796	128	55.1561	144	55.2041	166
55.0352	126	55.0797	128	55.1562	144	55.2042	166
55.0353	126	55.0798	128	55.1565	132	55.2043	166
55.0354	126	55.0799	128	55.1600	145	55.2044	166
55.0355	126	55.0800	128	55.1602	145	55.2045	166
55.0357	126	55.0801	128	55.1610	145	55.2046	166
55.0358	126	55.0802	128	55.1700	157	55.2059	166
55.0359	126	55.0803	128	55.1701	157	55.2060	166
55.0500	126,321	55.0804	128	55.1702	157	55.2061	166
55.0530	127	55.0805	128	55.1703	157	55.2062	166
55.0532	127	55.0806	128	55.1704	157	55.2063	166
55.0550	127	55.0807	128	55.1802	155	55.2064	166
55.0701	128	55.0808	128	55.1803	155	55.2065	166
55.0702	128	55.0809	128	55.1805	155	55.2066	166
55.0703	128	55.0851	128	55.1820	156	55.2079	166
55.0704	128	55.0902	129	55.1822	156	55.2080	166
55.0705	128	55.0930	133	55.1825	156	55.2081	166
55.0706	128	55.0932	133	55.1835	156	55.2082	166
55.0707	128	55.0933	133	55.1840	157	55.2083	166
55.0708	128	55.0934	133	55.1850	158	55.2084	166
55.0709	128	55.0936	133	55.1852	158	55.2085	166
55.0710	128	55.0937	134	55.1854	158	55.2086	166
55.0711	128	55.0938	134	55.1856	158	55.2109	167
55.0712	128	55.0940	134	55.1858	158	55.2110	167
55.0713	128	55.0942	134	55.1859	158	55.2111	167
55.0714	128	55.0944	134	55.1860	159	55.2112	167
55.0715	128	55.0945	134	55.1861	159	55.2113	167
55.0716	128	55.0947	135	55.1863	159	55.2114	167
55.0717	128	55.0948	135	55.1866	159	55.2115	167
55.0718	128	55.0949	135	55.1867	159	55.2116	167
55.0719	128	55.0951	136	55.1869	159	55.2117	167
55.0720	128	55.0956	136	55.1870	159	55.2118	167
55.0721	128	55.0962	136	55.1872	159	55.2119	167
55.0722	128	55.0963	136	55.1874	159	55.2120	167
55.0723	128	55.0965	137	55.1880	159	55.2127	167
55.0724	128	55.0966	137	55.1881	159	55.2128	167
55.0725	128	55.0968	137	55.1883	159	55.2129	167
55.0726	128	55.0970	138	55.1886	159	55.2130	167
55.0727	128	55.0971	138	55.1887	159	55.2131	167
55.0728	128	55.0973	138	55.1889	159	55.2132	167
55.0729	128	55.0975	138	55.1890	159	55.2133	167
55.0730	128	55.0977	139	55.1892	159	55.2134	167
55.0731	128	55.0980	139	55.1894	159	55.2135	167
55.0732	128	55.0981	139	55.1898	159	55.2136	167
55.0733	128	55.0982	139	55.1899	159	55.2137	167
55.0735	128	55.0983	139	55.1900	160	55.2138	167

Kat.Nr. Cat.No. No. Réf. No. Ref. No. Cat.	Seite Page Page Página Pagina
55.2139.....	167
55.2140.....	167
55.2141.....	167
55.2142.....	167
55.2143.....	167
55.2144.....	167
55.2145.....	167
55.2146.....	167
55.2147.....	167
55.2148.....	167
55.2149.....	167
55.2150.....	167
55.2151.....	167
55.2152.....	167
55.2153.....	167
55.2154.....	167
55.2155.....	167
55.2156.....	167
55.2157.....	167
55.2158.....	167
55.2159.....	167
55.2160.....	167
55.2171.....	168
55.2172.....	168
55.2173.....	168
55.2174.....	168
55.2175.....	168
55.2176.....	168
55.2178.....	169
55.2179.....	169
55.2181.....	164
55.2182.....	164
55.2183.....	164
55.2184.....	164
55.2185.....	164
55.2186.....	164
55.2190.....	165
55.2191.....	165
55.2192.....	165
55.2193.....	165
55.2194.....	165
55.2201.....	163
55.2202.....	163
55.2203.....	163
55.2204.....	163
55.2210.....	163
55.2221.....	165
55.2222.....	165
55.2223.....	165
55.2224.....	165
55.2225.....	165
55.2226.....	165
55.2240.....	162
55.2242.....	162
55.2244.....	162
55.2246.....	162
55.2250.....	162
55.2254.....	163
55.2255.....	163
55.2260.....	170
55.2261.....	170
55.2262.....	170
55.2263.....	170
55.2264.....	170
55.2265.....	170
55.2269.....	170
55.2290.....	171
55.2291.....	171
55.2292.....	171
55.2293.....	171
55.2294.....	171

Kat.Nr. Cat.No. No. Réf. No. Ref. No. Cat.	Seite Page Page Página Pagina
55.2295.....	171
55.2296.....	171
55.2297.....	171
55.3500.....	172
55.3502.....	172
55.3504.....	172
55.3510.....	172
55.3512.....	172
55.3514.....	172
55.3530.....	109,173
55.3600.....	54,173
56...	
56.0010.....	20,177
56.0020.....	20,177
56.0030.....	20,177
56.0050.....	177
56.0200.....	181
56.0202.....	181
56.0210.....	181
56.0220.....	182
56.0222.....	182
56.0224.....	181
56.0226.....	181
56.0230.....	182
56.0240.....	181
56.0250.....	182
56.0252.....	182
56.0260.....	182
56.0262.....	182
56.0265.....	182
56.0270.....	183
56.0272.....	183
56.0274.....	183
56.0280.....	183
56.0289.....	183
56.0290.....	183
56.0300.....	183
56.0310.....	184
56.0320.....	184
56.0350.....	184
56.0360.....	184
56.0400.....	181
56.0410.....	184
56.0500.....	186
56.0505.....	186
56.0506.....	186
56.0510.....	186
56.0515.....	185
56.0520.....	186
56.0600.....	180,186
56.0601.....	180,186
56.0700.....	185
56.0702.....	185
56.0710.....	189
56.0720.....	189
56.0721.....	189
56.0722.....	189
56.0723.....	189
56.0740.....	188
56.0748.....	188
56.0749.....	188
56.0800.....	187
56.0801.....	187
56.0805.....	187
56.0820.....	188
56.0880.....	83,142,190
56.0882.....	83,142,190
56.0890.....	142,190
56.0896.....	143,190
56.0898.....	143,190

Kat.Nr. Cat.No. No. Réf. No. Ref. No. Cat.	Seite Page Page Página Pagina
56.0900.....	191
56.0910.....	191
56.0911.....	191
56.1000.....	191
56.1001.....	191
56.1002.....	191
56.1003.....	191
56.1004.....	191
56.1005.....	191
58...	
58.0501.....	22
58.0520.....	22
58.0522.....	22
58.0530.....	22
58.0540.....	22
58.0550.....	22
58.0551.....	22
58.0553.....	22
58.0555.....	22
58.0600.....	22
58.0601.....	22
58.0621.....	22
58.0700.....	23
58.0710.....	23
58.0712.....	23
58.0715.....	23
58.1000.....	23
58.1001.....	23
58.1002.....	23
58.1003.....	23
58.1004.....	23
58.1040.....	23
80...	
80.0010.....	391
80.0012.....	391
80.0014.....	391
80.1000.....	391
80.1002.....	391
80.1010.....	391
80.1012.....	391
80.2000.....	391
80.2009.....	391
80.2020.....	392
80.2030.....	392
80.2031.....	392
80.2032.....	392
80.2060.....	392
80.2070.....	392
80.2072.....	392
80.2074.....	392
80.2076.....	392
80.2078.....	392
80.2090.....	392
80.2100.....	393
80.2101.....	393
80.2102.....	393
80.2104.....	393
80.2200.....	393
80.2202.....	393
80.2204.....	393
80.2206.....	393
80.2208.....	393
80.2210.....	393
80.2240.....	393
80.2242.....	393
80.2244.....	393
80.2246.....	393
80.2248.....	393
80.2250.....	393

Kat.Nr. Cat.No. No. Réf. No. Ref. No. Cat.	Seite Page Page Página Pagina
80.2252.....	393
80.2254.....	393
80.2256.....	393
80.2258.....	393
80.2260.....	393
80.2262.....	393
80.2270.....	393
80.2272.....	393
80.2280.....	394
80.2282.....	394
80.2284.....	394
80.2286.....	394
80.2288.....	394
80.2290.....	394
80.2292.....	394
80.2300.....	394
80.2302.....	394
80.2310.....	394
80.2315.....	394
80.2400.....	395
80.2401.....	395
80.2402.....	395
80.2406.....	395
80.2407.....	395
80.2408.....	395
80.2430.....	395
80.2432.....	395
80.2434.....	395
80.2436.....	395
80.2438.....	395
80.3112.....	390
80.3114.....	390
80.3116.....	390
80.3162.....	390
80.3164.....	390
80.3166.....	390
80.3190.....	389
80.4002.....	390
80.4004.....	390
80.4006.....	390
80.4008.....	390
80.4010.....	390
80.4012.....	390
80.4014.....	390
80.4016.....	390
80.4018.....	390
80.4020.....	390
80.4022.....	390
80.4024.....	390
80.4026.....	390
80.4028.....	390
80.4040.....	390
80.4042.....	390
80.4044.....	390
80.4046.....	390
80.4048.....	390
80.4050.....	390
80.4052.....	390
80.4054.....	390
80.4056.....	390
80.4058.....	390
80.4060.....	390
80.4062.....	390
80.4064.....	390
80.4100.....	395
80.4101.....	395
80.4102.....	395
80.4103.....	395
80.4104.....	395
80.6001.....	376
80.6001SL.....	376

Kat.Nr. Cat.No. No. Réf. No. Ref. No. Cat.	Seite Page Page Página Pagina	Kat.Nr. Cat.No. No. Réf. No. Ref. No. Cat.	Seite Page Page Página Pagina	Kat.Nr. Cat.No. No. Réf. No. Ref. No. Cat.	Seite Page Page Página Pagina	Kat.Nr. Cat.No. No. Réf. No. Ref. No. Cat.	Seite Page Page Página Pagina
80.6002.....	376	80.6540.....	379	80.7314.....	382	80.8222.....	389
80.6002SL.....	376	80.6541.....	379	80.7315.....	382	80.8223.....	389
80.6003.....	376	80.6601.....	380	80.7316.....	382	80.8224.....	389
80.6003SL.....	376	80.6601SL.....	380	80.7321.....	382		
80.6004.....	376	80.6602.....	380	80.7322.....	382		
80.6004SL.....	376	80.6602SL.....	380	80.7323.....	382		
80.6005.....	376	80.6603.....	380	80.7324.....	382		
80.6005SL.....	376	80.6603SL.....	380	80.7325.....	382		
80.6006.....	376	80.6604.....	380	80.7326.....	382		
80.6006SL.....	376	80.6604SL.....	380	80.7410.....	383		
80.6011.....	376	80.6605.....	380	80.7420.....	383		
80.6012.....	376	80.6605SL.....	380	80.7431.....	383		
80.6013.....	376	80.6606.....	380	80.7501.....	384		
80.6014.....	376	80.6606SL.....	380	80.7503.....	384		
80.6015.....	376	80.6611.....	380	80.7504.....	384		
80.6016.....	376	80.6612.....	380	80.7511.....	384		
80.6021.....	376	80.6613.....	380	80.7513.....	384		
80.6022.....	376	80.6614.....	380	80.7514.....	384		
80.6023.....	376	80.6615.....	380	80.7551.....	384		
80.6024.....	376	80.6616.....	380	80.7552.....	384		
80.6025.....	376	80.6621.....	380	80.7553.....	384		
80.6026.....	376	80.6622.....	380	80.7901.....	385		
80.6031.....	376	80.6623.....	380	80.7902.....	385		
80.6032.....	376	80.6624.....	380	80.7903.....	385		
80.6033.....	376	80.6625.....	380	80.7904.....	385		
80.6034.....	376	80.6626.....	380	80.7905.....	385		
80.6035.....	376	80.6631.....	380	80.7906.....	385		
80.6036.....	376	80.6632.....	380	80.7911.....	385		
80.6041.....	376	80.6633.....	380	80.7912.....	385		
80.6042.....	376	80.6634.....	380	80.7913.....	385		
80.6043.....	376	80.6635.....	380	80.7914.....	385		
80.6044.....	376	80.6636.....	380	80.7915.....	385		
80.6045.....	376	80.6641.....	380	80.7916.....	385		
80.6046.....	376	80.6642.....	380	80.7950.....	385		
80.6203.....	377	80.6643.....	380	80.7960.....	385		
80.6205.....	377	80.6644.....	380	80.7962.....	385		
80.6207.....	377	80.6645.....	380	80.7980.....	385		
80.6210.....	377	80.6646.....	380	80.8000.....	386		
80.6231.....	377	80.6803.....	381	80.8010.....	386		
80.6232.....	377	80.6805.....	381	80.8050.....	386		
80.6240.....	377	80.6807.....	381	80.8052.....	386		
80.6301.....	378	80.6810.....	381	80.8054.....	386		
80.6301SL.....	378	80.6813.....	381	80.8060.....	387		
80.6302.....	378	80.6815.....	381	80.8062.....	387		
80.6302SL.....	378	80.6817.....	381	80.8064.....	387		
80.6303.....	378	80.6820.....	381	80.8100.....	387		
80.6303SL.....	378	80.6841.....	381	80.8105.....	387		
80.6304.....	378	80.6842.....	381	80.8110.....	387		
80.6304SL.....	378	80.6850.....	381	80.8115.....	387		
80.6305.....	378	80.6851.....	381	80.8120.....	387		
80.6305SL.....	378	80.7001.....	382	80.8131.....	387		
80.6306.....	378	80.7002.....	382	80.8132.....	387		
80.6306SL.....	378	80.7003.....	382	80.8133.....	387		
80.6311.....	378	80.7004.....	382	80.8140.....	388		
80.6312.....	378	80.7005.....	382	80.8141.....	388		
80.6313.....	378	80.7006.....	382	80.8142.....	388		
80.6314.....	378	80.7011.....	382	80.8150.....	388		
80.6315.....	378	80.7012.....	382	80.8160.....	388		
80.6316.....	378	80.7013.....	382	80.8161.....	388		
80.6321.....	378	80.7014.....	382	80.8162.....	388		
80.6322.....	378	80.7015.....	382	80.8163.....	388		
80.6323.....	378	80.7016.....	382	80.8164.....	388		
80.6324.....	378	80.7301.....	382	80.8191.....	388		
80.6325.....	378	80.7302.....	382	80.8192.....	388		
80.6326.....	378	80.7303.....	382	80.8201.....	389		
80.6503.....	379	80.7304.....	382	80.8202.....	389		
80.6505.....	379	80.7305.....	382	80.8211.....	389		
80.6507.....	379	80.7306.....	382	80.8212.....	389		
80.6510.....	379	80.7311.....	382	80.8213.....	389		
80.6531.....	379	80.7312.....	382	80.8214.....	389		
80.6532.....	379	80.7313.....	382	80.8221.....	389		

