

**MULTIFUNCTIONAL
HOSPITAL TROLLEYS**

A U R I O N

Distributed in SA by:



SURGICAL AND MEDICAL SUPPLIES PTY LTD

16 Kensington Road Rose Park SA 5067

Telephone: (08) 8332 1666 Fax: (08) 8332 5132

Email: sales@surmed.com.au

Website: www.surmed.com.au





Top quality Top solution

AURION

4

Unibody System
COMPACT
MEGA

8

12

16

Mini System
MINI400 + MINI400D
MINI600

18

20

21

Monodose Cassette

22

Build your trolley
Custom configuration + Accessories

24



The Aurion trolleys for over 15 years have been a landmark of the Italian and international market. They distinguish themselves by the stylish and eclectic shape, making them increasingly practical and adaptable.

I carrelli Aurion da oltre 15 anni sono il punto di riferimento del mercato italiano ed internazionale. Si distinguono per la forma elegante ed eclettica, che li rende funzionali e adatti ad ogni occasione ed uso.

The unique and innovative

The material and the unique patented characteristics, combined with inimitable and aesthetical touch give life to a product extremely practical, sturdy and reliable.

The complete and innovative range of models, the wide offer of accessories and the continual development of the product allow versatile and cutting-edge solutions, adaptable to any hospital ward or use.

The large range of colors enhances the functionality and the aesthetics of the trolleys, to make the environment the most welcoming and comfortable as well as to distinguish wards or specific functions.

Aurion offers innovative mobile workplaces for emergency, anaesthesia, intensive care, OR, ISO-modules, medication, MRI and more.

Il materiale e le caratteristiche uniche brevettate, unite ad un gusto estetico inimitabile, danno vita ad un prodotto estremamente pratico, robusto ed affidabile.

La completa ed innovativa gamma di modelli, la vasta offerta di accessori e lo sviluppo continuo del prodotto permette soluzioni versatili e all'avanguardia, adattabili a qualsiasi reparto e utilizzo.

L'ampia gamma di colori esalta la funzionalità e l'estetica dei carrelli, aiutando a rendere accoglienti e confortevoli gli ambienti, oltre a distinguere reparti o funzioni specifiche.

Aurion offre stazioni di lavoro mobili per anestesia, terapia intensiva, emergenza, sala operatoria, farmacia, medicazione, MRI e molto altro ancora.

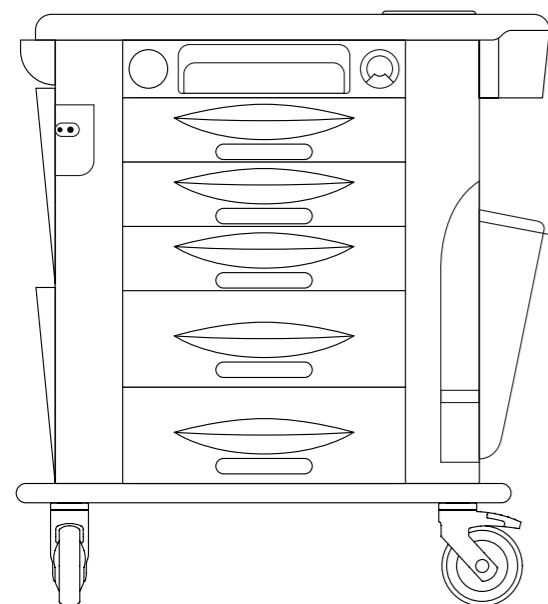

COMPACT

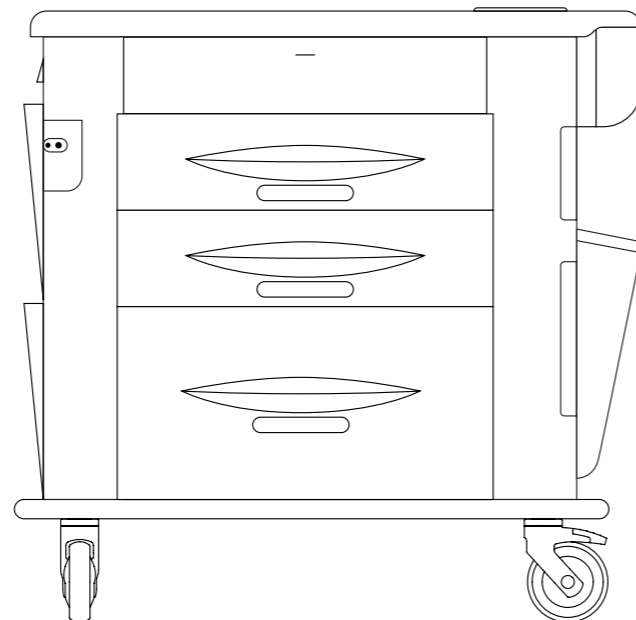

MEGA

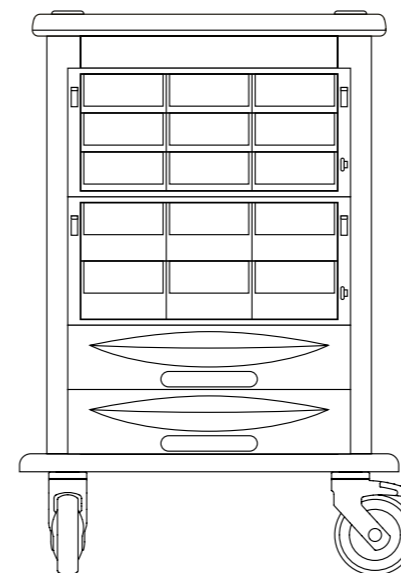

MINI400

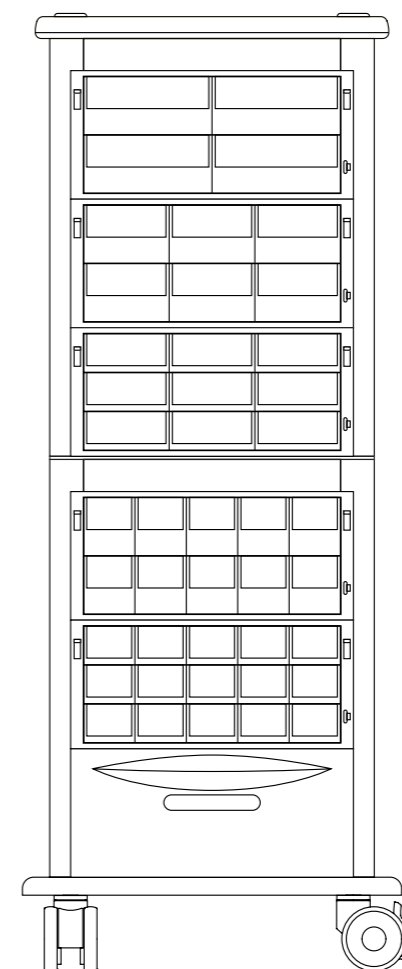

MINI400D

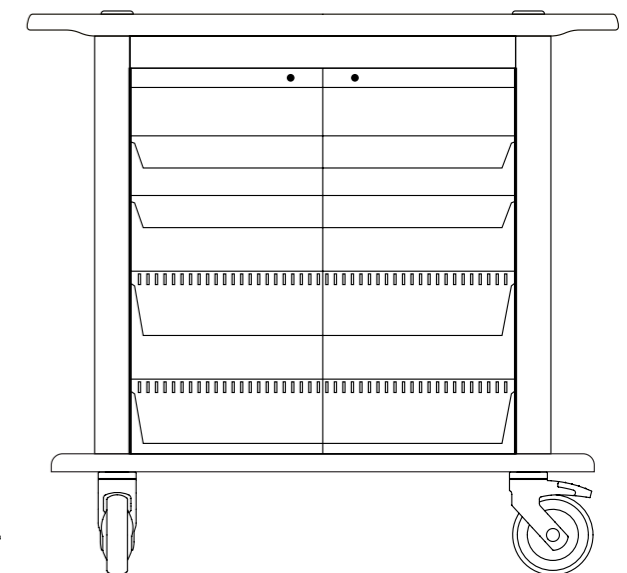

MINI600

Made in Polyurethane

Aurion trolleys are made in Baydur® Polyurethane, a high performance material that combines the best characteristics of plastics and metals.

- light, sturdy, high resistance to scratching and impact;
- resistant to UV rays;
- chemical inert, doesn't react to acids, organic and inorganic, alkali and solvents (DIN 68861/1);
- fire resistant, self-extinguishing (Class I, UL94 V-0);
- non-toxic, in case of combustion it doesn't produce dioxin;
- good thermal and acoustic insulation;
- long-lasting, keeps its properties intact for over 50 years.



I carrelli Aurion sono realizzati in Poliuretano Baydur®, materiale altamente performante che combina le migliori caratteristiche di plastiche e metalli.

- leggero, robusto, resistente a graffi e urti;
- resistente ai raggi UV;
- chimicamente inerte, resistente agli acidi, organici e inorganici, alle basi e ai solventi (DIN 68861/1);
- alta resistenza al fuoco, autoestinguente (Classe I, UL94-V0);
- completamente atossico, in caso di combustione non sviluppa diossine;
- buon isolante termico e acustico;
- longevo, mantiene inalterate le caratteristiche per oltre 50 anni.

Well-designed

The Aurion trolleys are ergonomic, modular, highly customizable and upgradable over the years.

The handles are moulded and integrated into the body* as well as the worktop that has large surface and perimetrical anti-drip containing rim.

* except for MINI400D

Every drawer is equipped with a label holder.

I carrelli Aurion sono ergonomici, modulari altamente personalizzabili e aggiornabili negli anni.

Le maniglie di spinta sono stampate ed integrate nel corpo del carrello* così come il piano di lavoro, dotato di ampia superficie di appoggio e bordo perimetrale anti-gocciolamento.

* escluso MINI400D

Ogni cassetto è dotato di un porta etichetta.

Easy to move

The ease to manoeuvre is guaranteed by the lightweight structure combined with the high quality non-marking and anti corrosion castors.

Every wheel is mounted on ball bearings with sealed lubrication (2 per wheel). 3 with brake, 1 antistatic.

La facilità di manovra è garantita dalla leggerezza della struttura combinata alle ruote di alta qualità con mescola antiriscaldamento, anti corrosione, montate su cuscinetti a sfera con lubrificazione sigillata (2 per ogni ruota). 3 con freno, 1 antistatica.

Hygienic and safe

The smoothly shaped design, without edges, guarantees safety to the user and avoids dirty and bacterial accumulation points. Aurion trolleys are easy to clean and disinfect also with aggressive detergents.

All the Aurion trolleys are latex free.

Il design dalle linee arrotondate, privo di spigoli, garantisce sicurezza all'utilizzatore ed evita punti di accumulo dello sporco e proliferazione batterica. I carrelli Aurion sono facili da pulire e disinfettare anche con detergenti aggressivi.

Tutti i carrelli Aurion sono latex free.

Eco-friendly

Aurion respects the environment. The main use of the polyurethane, the accurate design and the choice of high quality materials, matched with reliability, easy maintenance and upgradability guarantees an impressive long-life of every trolley. All Aurion trolley components are easily separable and completely recyclable in the event of disposal.

Aurion rispetta l'ambiente. L'utilizzo principale del poliuretano, la progettazione accurata e la scelta di materiali di qualità, uniti all'affidabilità, alla facilità di manutenzione e alla possibilità di aggiornamento garantiscono una vita dei carrelli estremamente lunga. ... e nell'eventualità dello smaltimento tutti i componenti dei carrelli Aurion sono facilmente separabili e completamente riciclabili.

The Aurion Unibody System trolleys are designed following the original concept of "monocoque": the trolley and the drawers are moulded in a single piece of Baydur® Polyurethane, that assures peerless sturdiness and reliability, great hygiene and perfect cleaning qualities.

La linea di carrelli Aurion Unibody System è concepita secondo il concetto originale di "monoscocca": il carrello e i cassetti sono stampati in un unico blocco di Poliuretano Baydur®, che assicura robustezza e affidabilità senza pari, grande igiene e perfetta pulizia.



Stable in every condition

They are easily maneuverable thanks to the lightness and the special fixing system of the castors, that distributes homogeneously the weight and guarantees high stability also in case of strong accidental collisions.

Sono facili da manovrare grazie alla loro leggerezza e al particolare sistema di fissaggio delle ruote, che distribuisce il peso omogeneamente e garantisce grande stabilità anche in caso di forti urti accidentali.

Safe and secure

All-around soft rubber bumper help to avoid damages to hospital staff, patients, objects or to the trolley itself.

Il bordo inferiore è protetto da un paracolpi in gomma morbida per evitare danni al personale medico, pazienti, cose o al carrello stesso.

A central locking device is available to be chosen between key, seal or electronic lock.

E' disponibile un sistema di chiusura dei cassetti centralizzato a scelta tra chiave, sigillo o serratura elettronica.

Customizable and upgradable

The drawers slide on non-metallic guides directly integrated in the body, that makes the cleaning and the maintenance easy as well as allows the user to reposition and change the configuration to their liking.

I cassetti scorrono su guide non metalliche ricavate direttamente nella scocca, che ne rendono più facile la pulizia e la manutenzione oltre a permettere all'utente di riposizionarli o riconfigurarli a piacimento.

The large range of accessories allow to propose solutions fit to every needs. The final user can easily modify and upgrade the trolleys' equipment.

La vasta gamma di accessori permette di proporre soluzioni adattabili a qualsiasi esigenza. L'utente può modificare e aggiornare agevolmente la dotazione dei carrelli.

The Aurion Unibody System trolleys are also available antimagnetic/MRI.

I carrelli Aurion Unibody System sono disponibili anche in versione amagnetica/MRI.



Fully equipped

Most of the accessories normally used in the hospitals are already integrated in the body and located in the protective perimeter of the rubber bumper, all compact and safe.

Gran parte degli accessori normalmente in uso nell'ambiente ospedaliero sono già integrati nella scocca e alloggiati all'interno del perimetro protettivo del paracolpi in gomma, a tutto vantaggio della compattezza e della sicurezza.

The standard trolleys always include:

- drawer for medication basin with stainless steel 18/10 medication basin;
- a lockable life-saving drugs drawer;
- used needle bucket/used cotton waste container;
- ampoule opener;
- waste bin with lid;
- oxygen tank holder (available as optional for Aurion MEGA);
- catheters compartments;
- sliding working top surface;
- 2 clear plastic swinging pockets (for IV bottles/patient files);
- bottle holder;
- 2 utility hooks;
- front storage.

Il carrello standard include sempre:

- cassetto medicazione con bacinella inox 18/10;
- cassetto per farmaci salvavita con serratura;
- contenitore aghi usati;
- rompi fiala;
- porta rifiuti con coperchio;
- supporto bombola ossigeno (disponibile come accessorio per Aurion MEGA);
- porta cateteri;
- piano di lavoro estraibile;
- 2 tasche basculanti in plastica trasparente;
- porta bottiglia;
- 2 ganci;
- porta-oggetti frontale.



CP ISOLATION

description	code	pcs
compact basic body - grey compact scocca base - grigio	CP0004	1
key lock chiusura con chiave	CP0210	1
drawer h 100 mm - yellow cassetto h 100 mm - giallo	CP1014	2
drawer h 200 mm - yellow cassetto h 200 mm - giallo	CP2014	2



CP ANESTHESIA

description	code	pcs
compact basic body - light blue compact scocca base - azzurro	CP0001	1
key lock chiusura con chiave	CP0210	1
drawer h 100 mm - light green cassetto h 100 mm - verde chiaro	CP1016	3
drawer h 300 mm - light green cassetto h 300 mm - verde chiaro	CP3016	1
poles kit kit pali	CP2600	1
dispenser - 11 bins - grey dispenser - 11 cassettoni - grigio	2405	1
holding frame - small + large telaio vaschette - piccolo + grande	2700 + 2800	1+1
shelf - small + large mensola - piccola + grande	2900 + 2910	1+1
accessories rail - 25x10 mm barra porta accessori - 25x10 mm	3400	1
plastic clamp for accessories fixing - double morsetto per fissaggio accessori - doppio	4310	1
IV pole - adjustable asta flebo - regolabile	1700	1



CP EMERGENCY 3

description	code	pcs
compact basic body - beige compact scocca base - beige	CP0002	1
seal lock chiusura con sigillo	CP0220	1
drawer h 100 mm - blue cassetto h 100 mm - blu	CP1011	3
drawer h 150 mm - blue cassetto h 150 mm - blu	CP1511	2
drawer divider kit - adjustable kit divisorio cassetti - regolabile	CP0800	1
IV pole - adjustable asta flebo - telescopica	1700	1
defibrillator holder tray supporto porta defibrillatore	1800	1
CPR massage board tavola massaggio RCP	CP4500	1
electric plug presa elettrica	refer to accessories section for your country plug socket	1



CP THERAPY

description	code	pcs
compact basic body - beige compact scocca base - beige	CP0002	1
key lock chiusura con chiave	CP0210	1
drawer h 200 mm - green cassetto h 200 mm - verde	CP2012	3
poles kit kit pali	CP2600	1
dispenser - 11 bins - grey dispenser - 11 cassettoni - grigio	2405	1
holding frame - small + large telaio vaschette - piccolo + grande	2700 + 2800	1+1
shelf - small + large mensola - piccola + grande	2900 + 2910	1+1
accessories rail - 25x10 mm barra porta accessori - 25x10 mm	3400	1
plastic clamp for accessories fixing - double morsetto per fissaggio accessori - doppio	4310	1
IV pole - adjustable asta flebo - regolabile	1700	1



CP EMERGENCY 4

description	code	pcs
compact basic body - grey compact scocca base - grigio	CP0004	1
seal lock chiusura con sigillo	CP0220	1
drawer h 100 mm - red cassetto h 100 mm - rosso	CP1013	3
drawer h 150 mm - red cassetto h 150 mm - rosso	CP1513	2
drawer divider kit - adjustable kit divisorio cassetti - regolabile	CP0800	1
IV pole - adjustable asta flebo - telescopica	1700	1
defibrillator holder tray supporto porta defibrillatore	1800	1
shelf for suction pump mensola per pompa di aspirazione	4600	1
CPR massage board tavola massaggio RCP	CP4500	1
electric plug presa elettrica	refer to accessories section for your country plug socket	1



CP MEDICATION

description	code	pcs
compact basic body - wisteria compact scocca base - glicine	CP0003	1
key lock chiusura con chiave	CP0210	1
drawer h 150 mm - light blue cassetto h 150 mm - azzurro	CP1515	4
poles kit kit pali	CP2600	1
dispenser - 11 bins - white dispenser - 11 cassettoni - bianco	2406	1
holding frame - large telaio vaschette - grande	2800	2
kit basins h 45 mm - white kit vaschette h 45 mm - bianco	3106	1
kit basins h 90 mm - white kit vaschette h 90 mm - bianco	3206	1
glove box holder - single supporto per scatola guanti - singolo	3300	1
disinfectant dispenser - with basin dispenser disinfettante - con vaschetta	3710	1





SUGGESTED CONFIGURATION

CP MONODOSE

description	code	pcs
compact basic body - light blue compact scocca base - azzurro	CP0001	1
key lock chiusura con chiave	CP0210	1
drawer h 100 mm - blue cassetto h 100 mm - blu	CP1011	1
drawer h 150 mm - blue cassetto h 150 mm - blu	CP1511	2
monodose cassette - 10 bins cassetta monodose - 10 bins	1060	1
poles kit kit pali	CP2600	1
dispenser - 11 bins - grey dispenser - 11 cassettoni - grigio	2405	1
holding frame - small telaio vaschette - piccolo	2700	1
shelf - small mensola - piccola	2900	1



CP PEDRIATIC

description	code	pcs
compact basic body - wisteria compact scocca base - glicine	CP0003	1
key lock chiusura con chiave	CP0210	1
drawer h 100 mm - red cassetto h 100 mm - rosso	CP1013	1
drawer h 100 mm - brown cassetto h 100 mm - marrone	CP1018	1
drawer h 100 mm - light blue cassetto h 100 mm - azzurro	CP1015	1
drawer h 100 mm - yellow cassetto h 100 mm - giallo	CP1014	1
drawer h 100 mm - light green cassetto h 100 mm - verde chiaro	CP1016	1
drawer h 100 mm - violet cassetto h 100 mm - fucsia	CP1017	1
perimetral protection protezione perimetrale	CP2200	1
pediatric mattress materassino pediatrico	CP2300	1
shelf for suction pump mensola per pompa di aspirazione	4600	1



Aurion Compact is compatible with ISO 600x400 trays and Aurion Monodose Cassette.
Aurion Compact è compatibile con vassoi ISO 600x400 e Aurion Cassette Monodose.

MG ISOLATION

description	code	pcs
mega basic body - grey mega scocca base - grigio	MG0004	1
key lock chiusura con chiave	MG0210	1
drawer h 100 mm - yellow cassetto h 100 mm - giallo	MG1014	2
drawer h 200 mm - yellow cassetto h 200 mm - giallo	MG2014	2



MG ANESTHESIA

description	code	pcs
mega basic body - light blue mega scocca base - azzurro	MG0001	1
key lock chiusura con chiave	MG0210	1
drawer h 100 mm - light green cassetto h 100 mm - verde chiaro	MG1016	3
drawer h 300 mm - light green cassetto h 300 mm - verde chiaro	MG3016	1
poles kit kit pali	MG2600	1
glove box holder - multiple supporto per scatola guanti - multiplo	3310	1
holding frame - small telaio vaschette - piccolo	2700	2
shelf - small mensola - piccola	2900	2
accessories rail - 25x10 mm barra porta accessori - 25x10 mm	3400	1



MG EMERGENCY 3

description	code	pcs
mega basic body - wisteria mega scocca base - glicine	MG0003	1
seal lock chiusura con sigillo	CP0220	1
drawer h 100 mm - blue cassetto h 100 mm - blu	MG1011	3
drawer h 150 mm - blue cassetto h 150 mm - blu	MG1511	2
drawer divider kit - adjustable kit divisorio cassetti - regolabile	MG0800	1
IV pole - adjustable asta flebo - telescopica	1700	1
defibrillator holder tray supporto porta defibrillatore	1800	1
CPR massage board tavola massaggio RCP	MG4500	1
electric plug presa elettrica	refer to accessories section for your country plug socket	1



MG THERAPY

description	code	pcs
mega basic body - light blue mega scocca base - azzurro	MG0001	1
key lock chiusura con chiave	MG0210	1
drawer h 100 mm - green cassetto h 100 mm - verde	MG1012	6
poles kit kit pali	MG2600	1
dispenser - 11 bins - grey dispenser - 11 cassettoni - grey	2405	1
holding frame - small telaio vaschette - piccolo	2700	1
shelf - small mensola - piccola	2900	1
accessories rail - 25x10 mm barra porta accessori - 25x10 mm	3400	1
plastic clamp for accessories fixing - double morsetto per fissaggio accessori - doppio	4310	1
IV pole - adjustable asta flebo - regolabile	1700	1
lamp 12 V lamp 12 V	MG4200	1



MG EMERGENCY 4

description	code	pcs
mega basic body - beige mega scocca base - beige	MG0002	1
seal lock chiusura con sigillo	MG0220	1
drawer h 100 mm - red cassetto h 100 mm - rosso	MG1013	3
drawer h 150 mm - red cassetto h 150 mm - red	MG1513	2
drawer divider kit - adjustable kit divisorio cassetti - regolabile	MG0800	1
IV pole - adjustable asta flebo - telescopica	1700	1
defibrillator holder tray supporto porta defibrillatore	1800	1
shelf for suction pump mensola per pompa di aspirazione	4600	1
CPR massage board tavola massaggio RCP	MG4500	1
electric plug presa elettrica	refer to accessories section for your country plug socket	1



MG MEDICATION

description	code	pcs
mega basic body - grey mega scocca base - grigio	MG0004	1
key lock chiusura con chiave	MG0210	1
drawer h 150 mm - light blue cassetto h 150 mm - azzurro	MG1515	4
poles kit kit pali	MG2600	1
dispenser - 11 bins - white dispenser - 11 cassettoni - bianco	2406	1
holding frame - small telaio vaschette - piccolo	2700	1
holding frame - large telaio vaschette - grande	2800	1
shelf - small mensola - grande	2900	1
shelf - large mensola - grande	2910	1
lamp 12 V lamp 12 V	MG4200	1
disinfectant dispenser - with basin dispenser disinfettante - con vaschetta	3710	1



The Aurion Mini System offers a new and simple way to handle your medicine logistic and hospital supplies, allowing a safe and quick integration of medicine logistics and distribution, from pharmacy to patients.



La linea di carrelli Aurion Mini System offre una nuova e semplice soluzione per la gestione dei farmaci e delle forniture ospedaliere, permettendo un'integrazione sicura e rapida della logistica della distribuzione, dalla farmacia al paziente.

Simple but with Aurion quality

The Aurion Mini System trolleys have been designed with the purpose to be simple and functional with the usual Aurion quality.

Top, base and sides made in Baydur® Polyurethane (internal sides in ABS) assure lightness, sturdiness and easy to clean.

I carrelli della linea Aurion Mini sono stati progettati con lo scopo di essere semplici e funzionali con la consueta qualità Aurion.

Il top, la base e i fianchi realizzati in poliuretano Baydur® (pannellatura interna in ABS) assicurano leggerezza, robustezza e facilità di pulizia.

Capacious and flexible

The Aurion Mini System trolleys are very capacious and can be configured with drawers*, Aurion Monodose Cassettes, ISO 600x400 trays and many accessories offer endless possibilities of configuration to adapt to the most specific needs.

* the drawers disposition can be chosen by the user at the moment of the order.

I carrelli Aurion Mini sono molto capienti e possono essere configurati con cassette*, Aurion Cassette Monodose e vassoi ISO 600x400 oltre a diversi accessori, offrendo infinite possibilità di configurazione per adattarli anche alle esigenze più particolari.

* la disposizione dei cassette può essere scelta dall'utente al momento dell'ordine.

Customizable and upgradable

The Aurion Mini trolleys can be upgraded and adjusted thanks to the large Aurion accessories range. The accessories and the components are available individually and easily replaceable by the final user.

I carrelli Aurion Mini possono essere aggiornati e adattati grazie alla vasta gamma di accessori Aurion. Gli accessori e le componenti sono disponibili singolarmente e facilmente sostituibili dall'utente.





Light and efficient solutions to handle your medicines logistics.

La soluzione leggera ed efficiente per gestire la logistica dei farmaci.

The simple way to handle your hospital supplies.

La soluzione più semplice per la gestione delle forniture ospedaliere.



Capacious

Trolleys can be fitted with up to 12 Monodose Cassettes (up to 180 patient bins) at any time, reducing the number of trips required to dispense medicines from the pharmacy to wards.

Capienti. Possono contenere fino a 12 Cassette Monodose (più di 180 contenitori personali) riducendo così il numero di viaggi richiesto per la distribuzione dalla farmacia ai reparti.

Safe

The locking system will secure drawers and Monodose Cassettes in the trolley body and, at the same time, all patient bins in the Monodose Cassettes.

Sicuri. Il sistema di chiusura bloccherà tutti i cassetti e le Cassette Monodose nel corpo del carrello e, nel contempo, tutti i contenitori dei pazienti nelle Cassette Monodose.

Handy

Double sided trolley. Both sides are accessible at the same time.

Pratici. Sono bifacciali e accessibili da entrambi i lati nello stesso momento.

Quick

A single action lock will allow access to all patient bins in any Monodose Cassette.

Rapidi. Con un unico azionamento della serratura si avrà accesso a tutti i contenitori dei pazienti nelle Cassette Monodose.

MINI 600 is compatible with ISO 600x400 trays and it can be accessorized with files holder, doors and various accessories, giving you endless combination possibilities.

MINI600 è compatibile con vassoi ISO 600x400, può essere accessorizzato con porta-cartelle, ante e accessori vari, offrendo così infinite combinazioni.

The innovative logistic and distribution medicine system.

L'innovativo sistema di logistica e distribuzione farmaci.



The Monodose Cassette (MC) acts as a normal drawer, it is easy to remove from the basic body. Each MC includes a handle to make transfer from storage to trolleys easier moreover they are stackable.

If the MC is in the trolley body, the trolley's central locking system closes both the cassette and the individual bins, once the MC is free standing the bins can be locked by a seal.

Personal bins are provided with the MC, every bin includes a label, 3 dividers and a clear plastic sliding top.

Compatible with Aurion COMPACT, Aurion MINI400 and MINI400D.

La Cassetta Monodose (CM) funziona come un cassetto normale e può facilmente essere rimossa dal corpo base. Ogni CM è dotata di una maniglia che agevola il trasferimento dal deposito ai carrelli; oltre ad essere impilabile.

Se la CM è inserita nel carrello la chiusura centralizzata del carrello blocca sia la cassetta che i singoli bin, quando la CM è fuori dal carrello i bin possono essere bloccati con un sigillo.

I bin sono forniti con la CM, ogni bin include un'etichetta, 3 divisori e un coperchio scorrevole trasparente.

Compatibili con Aurion COMPACT, Aurion MINI400 e MINI400D.

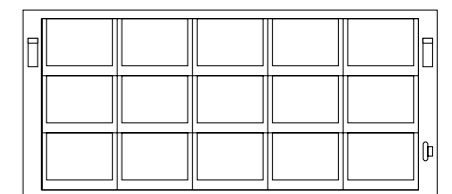
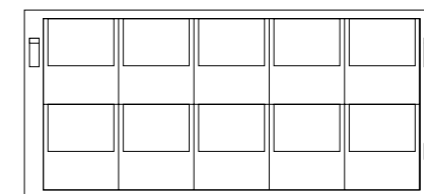
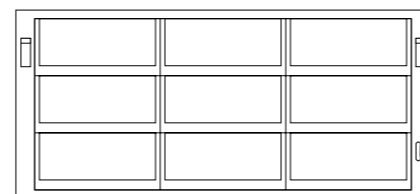
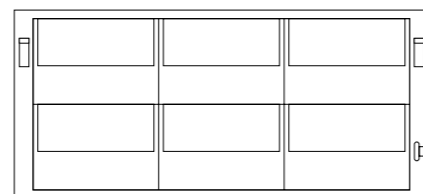
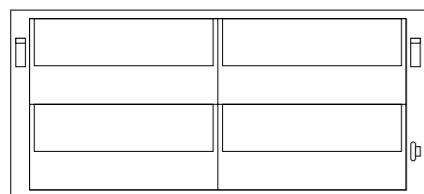

Build your trolley

Set up the trolley to your needs in four steps:

1. trolley basic body;
2. locking system;
3. front configuration;
4. accessories.

Configura il carrello in base alle tue necessità in quattro mosse:

1. corpo base;
2. sistema di chiusura;
3. configurazione del frontale;
4. accessori.

Do you need something particular that you can't find in our catalog?
Any modifications or customizations?

We are the direct manufacturer of our trolleys, this allows us the greater productive flexibility.
Contact us and we will do our utmost to satisfy you.





Hai bisogno di qualcosa di particolare che non trovi nel catalogo?
Qualche modifica o personalizzazione?

Siamo i produttori diretti dei nostri carrelli, questo ci permette una grande flessibilità produttiva.
Contattaci e faremo il possibile per soddisfarvi.

1 Trolley basic body corpo base

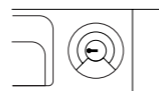
description	code				
	COMPACT	MEGA	MINI400	MINI400D	MINI600
light blue azzurro	CP0001	MG0001	MQ0001	MD0001	MS0001
beige beige	CP0002	MG0002	MQ0002	MD0002	MS0002
wisteria glicine	CP0003	MG0003	MQ0003	MD0003	MS0003
grey grigio	CP0004	MG0004	MQ0004	MD0004	MS0004
	body dimensions 830x715x910h mm	body dimensions 970x625x960h mm	body dimensions 590x993x880h mm	body dimensions 590x993x1490h mm	body dimensions 993x590x880h mm
	packaging dimensions 980x770x1130h mm	packaging dimensions 111x670x1140h mm	packaging dimensions 980x770x1130h mm	packaging dimensions 980x770x1720h mm	packaging dimensions 980x770x1130h mm

2 Locking system sistema di chiusura

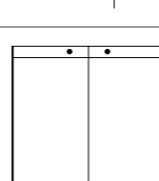
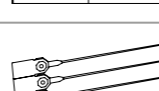

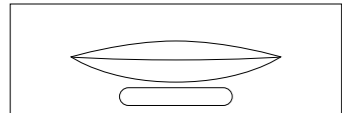
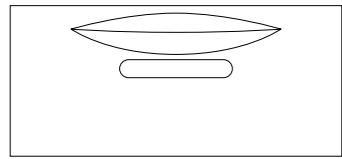

description	code				
	COMPACT	MEGA	MINI400	MINI400D	MINI600
 no lock (suitable for MRI) senza serratura (consigliabile per MRI)	0200				
 key lock chiusura con chiave	CP0210	MG0210	MQ0210	MD0210	
 keyless lock chiusura con chiave elettronica	CP0211				
 seal lock chiusura con sigillo	CP0220	MG220			
 seal lock with flashing led chiusura con sigillo e led di controllo	CP0221				
 doors with key lock sportelli con chiusura a chiave	h 500 mm	CP1200	MG1200		MS1200
	h 600 mm	CP1210	MG1210		MS1210
 numbered breakaway seals kit (x100 pcs) kit sigilli numerati (x100 pezzi)	0400				

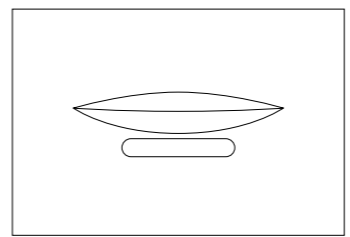
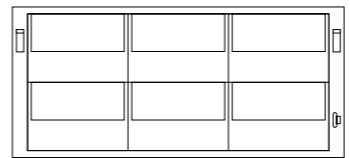
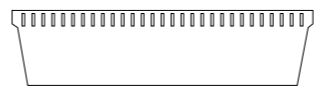
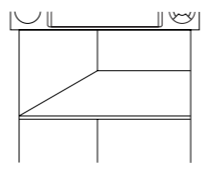



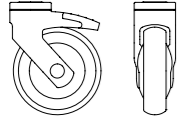
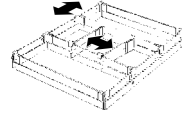

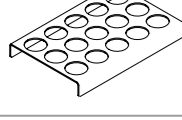
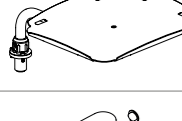
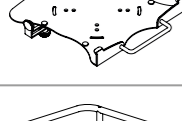
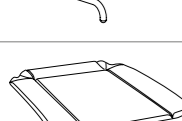
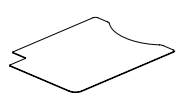
3 Front configuration configurazione del frontale

description	code				
	COMPACT	MEGA	MINI400	MINI400D	MINI600
 <p>drawer h 100 mm (max 6 pieces per trolley) cassetto h 100 mm (max 6 pezzi per carrello)</p>	red rosso	CP1013	MG1013	MQ1013	MQ1013
	orange arancione	CP1019	MG1019	MQ1019	MQ1019
	yellow giallo	CP1014	MG1014	MQ1014	MQ1014
	light green verde chiaro	CP1016	MG1016	MQ1016	MQ1016
	green verde	CP1012	MG1012	MQ1012	MQ1012
	light blue azzurro	CP1015	MG1015	MQ1015	MQ1015
	blue blu	CP1011	MG1011	MQ1011	MQ1011
	violet fucsia	CP1017	MG1017	MQ1017	MQ1017
	brown marrone	CP1018	MG1018	MQ1018	MQ1018
	internal dimensions 585x365 mm	internal dimensions 500x500 mm	internal dimensions 260x345 mm	internal dimensions 260x345 mm	
 <p>drawer h 150 mm (max 4 pieces per trolley) cassetto h 150 mm (max 4 pezzi per carrello)</p>	red rosso	CP1513	MG1513		
	orange arancione	CP1519	MG1519		
	yellow giallo	CP1514	MG1514		
	light green verde chiaro	CP1516	MG1516		
	green verde	CP1512	MG1512		
	light blue azzurro	CP1515	MG1515		
	blue blu	CP1511	MG1511		
	violet fucsia	CP1517	MG1517		
	brown marrone	CP1518	MG1518		
	internal dimensions 585x365 mm	internal dimensions 500x500 mm	internal dimensions 260x345 mm	internal dimensions 260x345 mm	
 <p>drawer h 200 mm (max 3 pieces per trolley) cassetto h 200 mm (max 3 pezzi per carrello)</p>	red rosso	CP2013	MG2013	MQ2013	MQ2013
	orange arancione	CP2019	MG2019	MQ2019	MQ2019
	yellow giallo	CP2014	MG2014	MQ2014	MQ2014
	light green verde chiaro	CP2016	MG2016	MQ2016	MQ2016
	green verde	CP2012	MG2012	MQ2012	MQ2012
	light blue azzurro	CP2015	MG2015	MQ2015	MQ2015
	blue blu	CP2011	MG2011	MQ2011	MQ2011
	violet fucsia	CP2017	MG2017	MQ2017	MQ2017
	brown marrone	CP2018	MG2018	MQ2018	MQ2018
	internal dimensions 585x365 mm	internal dimensions 500x500 mm	internal dimensions 260x345 mm	internal dimensions 260x345 mm	

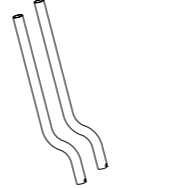

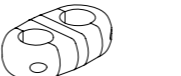
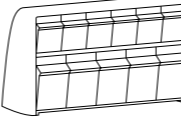
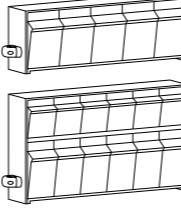
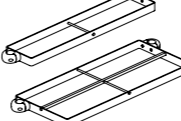
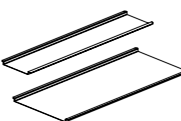



description	code				
	COMPACT	MEGA	MINI400	MINI400D	MINI600
 <p>drawer h 300 mm (max 2 pieces per trolley) cassetto h 300 mm (max 2 pezzi per carrello)</p>	red rosso	CP3013	MG3013		
	orange arancione	CP3019	MG3019		
	yellow giallo	CP3014	MG3014		
	light green verde chiaro	CP3016	MG3016		
	green verde	CP3012	MG3012		
	light blue azzurro	CP3015	MG3015		
	blue blu	CP3011	MG3011		
	violet fucsia	CP3017	MG3017		
	brown marrone	CP3018	MG3018		
	internal dimensions 585x365 mm	internal dimensions 500x500 mm	internal dimensions 260x345 mm	internal dimensions 260x345 mm	
 <p>monodose cassette (h 200 mm) cassetto monodose (h 200 mm)</p>	MC 4 bins	1000		1000	1000
	single bin 4	1010		1010	1010
	MC 6 bins	1020		1020	1020
	single bin 6	1030		1030	1030
	MC 9 bins	1040		1040	1040
	single bin 9	1050		1050	1050
	MC 10 bins	1060		1060	1060
	single bin 10	1070		1070	1070
	MC 15 bins	1080		1080	1080
	single bin 15	1090		1090	1090
 <p>ABS ISO 600x400 trays vassoio in ABS ISO 600x400</p>	h 50 mm	1300		1300	1300
	h 100 mm	1310		1310	1310
 <p>shelf mensola</p>	CP1400	MG1400	CP1400	CP1400	MG1400
	patient files holder porta cartelle				

4 Accessories accessori

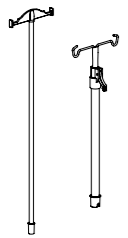
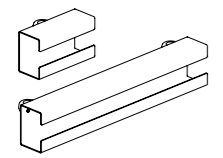

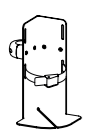
description	code				
	COMPACT	MEGA	MINI400	MINI400D	MINI600
 anti magnetic wheels for MRI trolley ruote per carrello risonanza magnetica	CP0100	MG0100			
 drawer divider kit - adjustable system kit divisorio cassetti regolabile	CP0800	MG0800			
 drawer divider kit - comb kit divisorio cassetti fisso	CP0810	MG0810			
 IV bottles shelf for drawer vascio porta flaconi flebo per cassetto	CP0900	MG0900			
 defibrillator holder tray stainless steel including straps and anti-sliding pad supporto porta defibrillatore inox include cinghie e tappetino anti slittamento	1800	1800	MQ1800		MQ1800
 notebook holder (with security cable) porta notebook (con cavo di sicurezza)	1900	1900	1900		1900
 perimetral protection protezione perimetrale	CP2200				
 pediatric mattress materassino pediatrico	CP2300				
 cover top soft rubber copertura ripiano gomma morbida	CP2100	MG2100	MQ2100		MQ2100

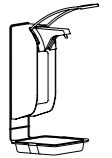
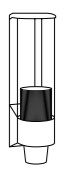
description	code				
	COMPACT	MEGA	MINI400	MINI400D	MINI600
 poles kit for accessories support stainless steel kit pali supporto accessori inox	standard	CP2600	MG2600	MQ2600	MQ2600
	long	CP2610	MG2620	MQ2610	MQ2610
 short pole for accessories support (250 mm) palo corto per supporto accessori (250 mm)	2620	2620	2620		2620
 plastic clamp for accessories fixing (x3 pcs) morsetto per fissaggio accessori (x3 pezzi)	4310*	4310*	4310*		4310*
 dispenser 11 tilt-out bins dispenser 11 cassettoni	grey grigio	2405	2405	2405	2405
	white bianco	2406	2406	2406	2406
 dispenser with tilt-out bins dispenser con cassettoni	5 bins	2500	2500	2500	2500
	6 bins	2510	2510	2510	2510
	10 bins	2520	2520	2520	2520
	12 bins	2530	2530	2530	2530
 holding frame stainless steel telaio vaschette inox	small	2700	2700	2700	2700
	large	2800	2800	2800	2800
 shelf stainless steel mensola inox	small	2900	2900	2900	2900
	large	2910	2910	2910	2910
 kit basins h 45 mm (x2 pcs) kit vaschette h 45 mm (x2 pezzi)	grey grigio	3105	3105	3105	3105
	white bianco	3106	3106	3106	3106
 kit basins h 90 mm (x2 pcs) kit vaschette h 90 mm (x2 pezzi)	grey grigio	3205	3205	3205	3205
	white bianco	3206	3206	3206	3206
 accessories rail stainless steel barra porta accessori inox	25x10 mm	3400	3400	3400	3400
	30x10 mm	3410	3410	3410	3410

* to use in combination with adjustable IV pole (code 1700) when poles system is installed.
da usare in abbinamento con asta flebo telescopica (codice 1700) in presenza del sistema pali supporto accessori.

description	code				
	COMPACT	MEGA	MINI400	MINI400D	MINI600
 IV pole asta portaflebo	fixed height	CP1710	MG1710	MD1710	MD1710
	adjustable	1700*	1700*	1700*	1700*
 glove box holder supporto per scatola guanti	single	3300	3300	3300	3300
	multiple	3310	3310	3310	3310
 medication basin + holder stainless steel vaschetta medicazione + supporto inox		3900	3900	3900	3900
 needle bucket holder supporto per porta taglienti		3500	3500	3500	3500
 1,5 l needle bucket kit (x10 pcs) kit porta taglienti 1,5 l (x10 pezzi)		3600	3600	3600	3600
 disinfectant dispenser dispenser disinfettante	simple	3700	3700	3700	3700
	with basin	3710	3710	3710	3710
 cup dispenser dispenser bicchieri		3800	3800	3800	3800
 stop watch chronograph cronografo contasecondi		4100	4100	4100	4100
 lamp 12 V lampada 12 V		CP4200	MG4200	CP4200	CP4200

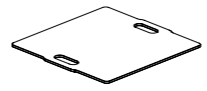
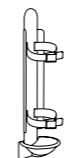
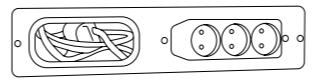
* when poles system is installed use with plastic clamp (code 4310)
in presenza del sistema pali usare il morsetto di fissaggio (code 4310)

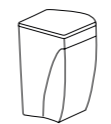
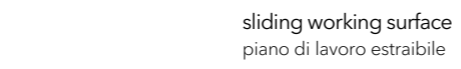
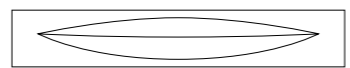
description	code				
	COMPACT	MEGA	MINI400	MINI400D	MINI600
 CPR massage board tavola massaggio RCP		CP4500	MG4500		
	MRI	CP4510	MG4510		
 oxygen tank hwwolder porta bombola per ossigeno	small	CP4700	MG4700		
	large	CP4710	MG4710		
 electric plug presa elettrica	EU	4400	4400		
	UK	4410	4410		
	FR/CZ/PL/B	4420	4420		
	US	4430	4430		
 shelf for suction pump mensola per pompa di aspirazione		4600*	4600*		
 waste bin pattumiera	10 l			MQ4800	MQ4800
	20 l	CP4810*	CP4810*	MQ4810	MQ4810
 sliding working surface piano di lavoro estraibile				MQ4900	
 notebook drawer h 50 mm cassetto per notebook h 50 mm	red rosso			MQ0513	MQ0513
	orange arancione			MQ0519	MQ0519
	yellow giallo			MQ0514	MQ0514
	light green verde chiaro			MQ0516	MQ0516
	green verde			MQ0512	MQ0512
	light blue azzurro			MQ0515	MQ0515
	blue blu			MQ0511	MQ0511
	violet fucsia			MQ0517	MQ0517
	brown marrone			MQ0518	MQ0518

* in place of the swinging pocket.
in sostituzione alle tasche basculanti.

Made in Italy
sold all over the world

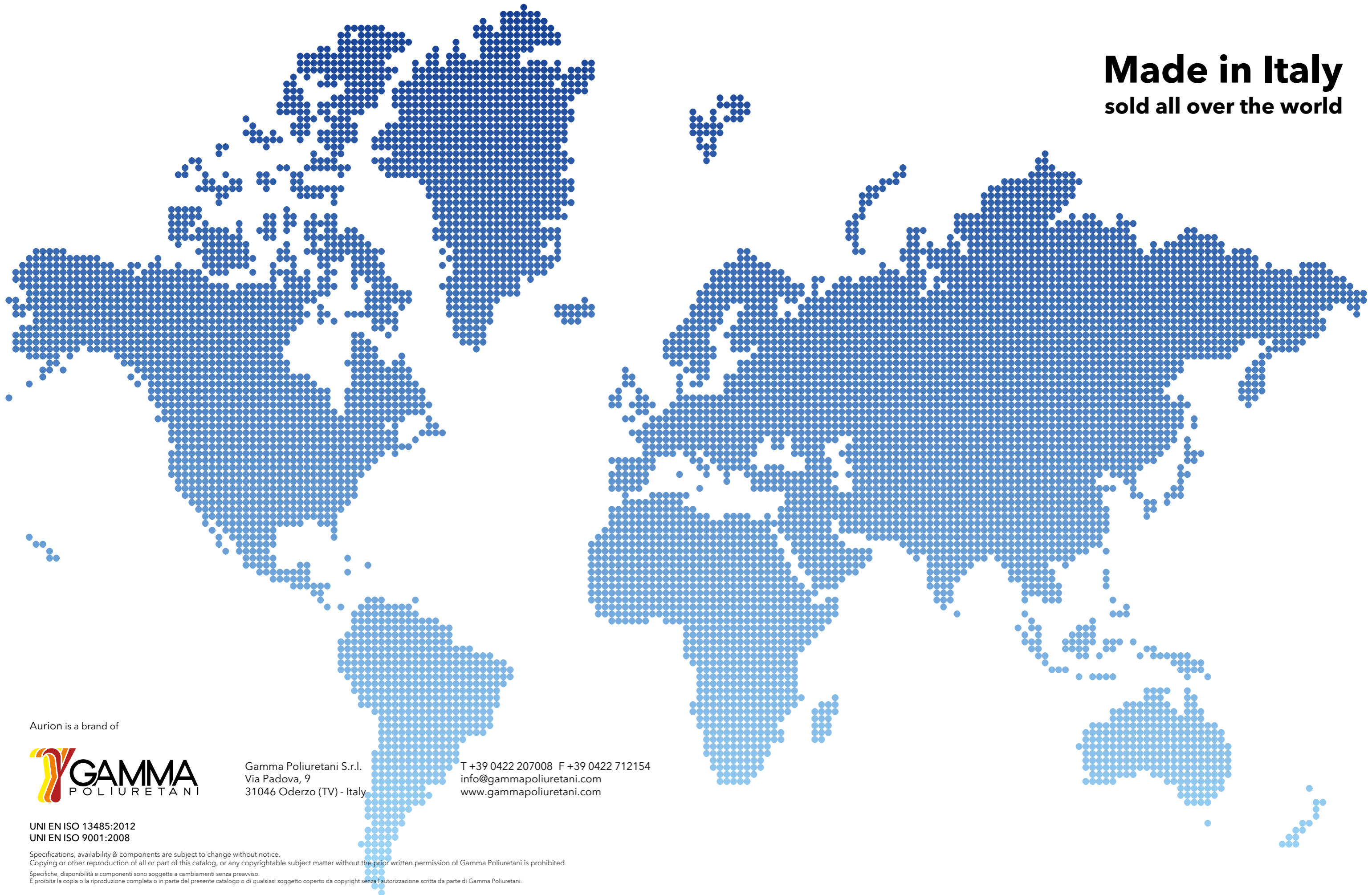

Aurion is a brand of



Gamma Poliuretani S.r.l.
Via Padova, 9
31046 Oderzo (TV) - Italy

T +39 0422 207008 F +39 0422 712154
info@gammapoliuretani.com
www.gammapoliuretani.com

UNI EN ISO 13485:2012
UNI EN ISO 9001:2008

Specifications, availability & components are subject to change without notice.
Copying or other reproduction of all or part of this catalog, or any copyrightable subject matter without the prior written permission of Gamma Poliuretani is prohibited.
Specifiche, disponibilità e componenti sono soggette a cambiamenti senza preavviso.
È proibita la copia o la riproduzione completa o in parte del presente catalogo o di qualsiasi soggetto coperto da copyright senza l'autorizzazione scritta da parte di Gamma Poliuretani.



A U R I O N

Made in Italy

T +39 0422 207008

F +39 0422 712154

info@aurionmedical.com

www.aurionmedical.com

